

Leica GPS1200 Technical Reference Manual



Version 5.5
English

- when it has to be **right**

Leica
Geosystems

Introduction

Purchase

Congratulations on the purchase of a GPS1200 Series instrument.



To use the product in a permitted manner, please refer to the detailed safety directions in the User Manual.

Product identification

The type and the serial number of your product are indicated on the type plate. Enter the type and serial number in your manual and always refer to this information when you need to contact your agency or Leica Geosystems authorized service workshop.

Type:

Serial No.:

Symbols

The symbols used in this manual have the following meanings:

Type	Description
	Important paragraphs which must be adhered to in practice as they enable the product to be used in a technically correct and efficient manner.

Trademarks

- Windows and Windows CE are a registered trademark of Microsoft Corporation
 - CompactFlash and CF are trademarks of SanDisk Corporation
 - Bluetooth is a registered trademark of Bluetooth SIG, Inc
- All other trademarks are the property of their respective owners.



Validity of this manual



- This manual applies to all GPS1200 instruments. Differences between the various models are marked and described.
- The RX1200 is available as RX1210 or with touch screen functionality as RX1210T, RX1250X, RX1250Xc, RX1250T or RX1250Tc. The name RX1210 is used throughout the manual and may also represent the touch screen models. Only use the supplied stylus on the screens of the touch screen models.

Illustrations

For the purpose of the illustrations, a GX1230 model has been selected which is representative for all models.

Available documentation

Name	Description	Format	
			
User Manual	All instructions required in order to operate the product to a basic level are contained in the User Manual. Provides an overview of the product together with technical data and safety directions.	X	X

Name	Description	Format	
			
System Field Manual	Describes the general working of the product in standard use. Intended as a quick reference field guide.		X
Application Programs Field Manual	Describes specific onboard application programs in standard use. Intended as a quick reference field guide. The RoadRunner application program is described in a separate manual.	X	X
Technical Reference Manual	Overall comprehensive guide to the product and program functions. Included are detailed descriptions of special software/hardware settings and software/hardware functions intended for technical specialists.		X

Refer to the following resources for all GPS1200 documentation and software:

- the SmartWorx DVD
- <http://www.leica-geosystems.com/downloads>

Table of Contents

In this manual

Chapter	Page
1 Equipment Setup	26
1.1 Receiver Ports	26
1.2 Post-Processed Static Reference on Pillar	30
1.3 Post-Processed Static Reference on Tripod	34
1.4 Post-Processed Kinematic, Pole and Minipack	38
1.5 Post-Processed Kinematic, All-on-Pole - Option 1	44
1.6 Post-Processed Kinematic, All-on-Pole - Option 2	48
1.7 Real-Time Reference, Single Tripod	51
1.8 Real-Time Reference, Two Tripods	55
1.9 Real-Time Reference using SmartAntenna, RX1250 and GHT56	59
1.10 SmartRover - External Radio	63
1.11 SmartRover - External Radio, Maximized Radio Coverage	67
1.12 Real-Time Rover, Pole and Minipack	71
1.13 Real-Time Rover, All-on-Pole - Option 1	77
1.14 Real-Time Rover, All-on-Pole - Option 2	80
1.15 Using the Minipack	83
1.16 Checking and Adjusting the Circular Level on the Tribach	86
2 Antenna Heights	90
2.1 Overview	90
2.2 Mechanical Reference Planes, MRP	93
2.3 Determining Antenna Heights	95
2.3.1 Pillar Setup	95

2.3.2	Tripod Setup	100
2.3.3	Pole Setup	103
2.4	Measuring Slope Antenna Heights	105
3	Using GPS1200 without RX1200	108
<hr/>		
4	Using RX1250	112
<hr/>		
4.1	Overview	112
4.2	Switching between Leica SmartWorx software and Windows CE desktop	113
4.3	Sleep Mode	115
4.4	Configuring Interfaces	116
4.4.1	Overview	116
4.4.2	Configuring SmartAntenna Interface	117
4.4.3	Configuring Clip-On Interface	119
5	Receiver Protection with PIN	120
<hr/>		
6	Configurable Keys	126
<hr/>		
6.1	Hot Keys	126
6.2	USER Key	128
7	Main Menu	130
<hr/>		
7.1	Main Menu Functions	130
7.2	Survey	133
7.3	Programs...	134
7.4	Manage...	136
7.5	Convert...	138
7.6	Config...	139
7.7	Tools...	140

8	Manage...\Jobs	142
8.1	Overview	142
8.2	Accessing Job Management	143
8.3	Creating a New Job	145
8.4	Editing a Job	149
8.5	Managing Job Codes	152
9	Manage...\Data	156
9.1	Overview	156
9.2	Accessing Data Management	157
9.3	Point Management	162
9.3.1	Terminology	162
9.3.2	Creating a New Point	172
9.3.3	Editing a Point	176
9.3.4	Mean Page	181
9.4	Line/Area Management	188
9.4.1	Overview	188
9.4.2	Creating a New Line/Area	189
9.4.3	Editing a Line/Area	193
9.4.4	Working Example	196
9.5	Data Log	199
9.6	Point Sorting and Filters	202
9.6.1	Sorting and Filters for Points, Lines and Areas	202
9.6.2	Point, Line and Area Code Filter	211
9.6.3	Stakeout Filter	213

10	Manage...\Codelists	216
10.1	Terminology	216
10.2	Overview	223
10.3	Accessing Codelist Management	224
10.4	Creating/Editing a Codelist	226
10.5	Managing Codes	227
	10.5.1 Accessing MANAGE Codes	227
	10.5.2 Creating a New Code	230
	10.5.3 Editing a Code	233
10.6	Managing Code Groups	234
11	Coding	236
11.1	Overview	236
11.2	Thematical Coding	239
	11.2.1 Thematical Coding with Codelist	239
	11.2.2 Thematical Coding without Codelist	244
11.3	Free Coding	246
	11.3.1 Free Coding Using a Codelist	246
	11.3.2 Free Coding with Direct Input	250
11.4	Quick Coding	252
11.5	SmartCodes	256
	11.5.1 Overview	256
	11.5.2 Configuring SmartCodes	257
	11.5.3 Code Block	261
	11.5.4 Using SmartCodes	264
11.6	Code and Attribute Mismatch	265
	11.6.1 Code Mismatch	265
	11.6.2 Attribute Mismatch	267

12	Linework	270
12.1	Overview	270
12.2	Performing Linework	271
12.3	Combining Linework and Coding	276
13	Manage...Coordinate Systems	284
13.1	Overview	284
13.2	Terminology	287
13.3	Accessing Coordinate System Management	290
13.4	Coordinate Systems	293
13.4.1	Creating a New Coordinate System	293
13.4.2	Editing a Coordinate System	295
13.5	Transformations	297
13.5.1	Accessing Transformation Management	297
13.5.2	Creating a New Transformation	300
13.5.3	Editing a Transformation	302
13.6	Ellipsoids	303
13.6.1	Accessing Ellipsoid Management	303
13.6.2	Creating a New Ellipsoid	305
13.6.3	Editing an Ellipsoid	306
13.7	Projections	307
13.7.1	Accessing Projection Management	307
13.7.2	Creating a New Projection	312
13.7.3	Editing a Projection	313
13.8	Geoid Models	314
13.8.1	Overview	314
13.8.2	Accessing Geoid Model Management	316

13.8.3	Creating a New Geoid Model from the CompactFlash Card / Internal Memory	318
13.9	CSCS Models	319
14	Manage...\Configuration Sets	320
<hr/>		
14.1	Overview	320
14.2	Accessing Configuration Set Management	321
14.3	Creating a New Configuration Set	323
14.3.1	Initial Steps	323
14.3.2	Configuration Set for Static Operations	325
14.3.3	Configuration Set for Post-Processed Kinematic Operations	328
14.3.4	Configuration Set for Real-Time Reference Operations	331
14.3.5	Configuration Set for Real-Time Rover Operations	334
14.4	Editing a Configuration Set	338
15	Manage...\Antennas	340
<hr/>		
15.1	Overview	340
15.2	Accessing Antenna Management	341
15.3	Creating a New Antenna	343
15.4	Editing an Antenna	345
16	Convert...\Export Data from Job	346
<hr/>		
16.1	Overview	346
16.2	Accessing the Data Export Functionality	348
16.3	Exporting Data from a Job to a Custom ASCII Format	349
16.4	Exporting Data from a Job to another Device	352
16.5	Exporting Data in DXF Format	354

17	Convert...\Import Data to Job	358
17.1	Overview	358
17.2	Accessing the Data Import Functionality	363
17.3	Importing Data in ASCII Format	364
17.4	Importing Data in GSI Format	366
17.5	Importing Data in DXF Format	368
18	Convert...\Copy Points Between Jobs	370
19	Config...\Survey Settings...	372
19.1	ID Templates	372
19.1.1	Overview	372
19.1.2	Accessing ID Template Configuration	374
19.1.3	Creating a New ID Template	376
19.1.4	Editing an ID Template	380
19.1.5	Deleting an ID Template	382
19.1.6	Working Example	383
19.2	Display Settings	386
19.3	Coding & Linework	392
19.4	Quality Control Settings	398
19.5	Logging of Raw Obs	401
19.6	Point Occupation Settings	407
19.6.1	Configuration of Point Occupation Settings	407
19.6.2	Working Example	419
19.7	Seismic Recording	421
19.8	Ring Buffer	424
19.8.1	Overview	424
19.8.2	Configuring and Using a Ring Buffer	426

20	Config...\Instrument Settings...	430
20.1	Antenna & Antenna Heights	430
20.2	Satellite Settings	433
20.3	Time Zone	438
20.4	Instrument ID	440
20.5	Set NET Parameters	442
21	Config...\General Settings...	446
21.1	Wizard Mode	446
21.2	Hot Keys & User Menu	448
21.3	Units & Formats	452
21.4	Language	460
21.5	Display, Beeps, Text	462
21.6	Start Up & Power Down	466
22	Config...\Interfaces... - General	474
22.1	Overview	474
22.2	Accessing Configuration Interfaces	475
22.3	Real-Time	478
22.3.1	Overview	478
22.3.2	Configuration without Real-Time Interface	480
22.3.3	Configuration of a Reference Real-Time Interface	481
22.3.4	Configuration of a Rover Real-Time Interface	493
22.3.5	Configuration with Digital Cellular Phone and Radio	507
22.3.6	Configuration of SBAS	508
22.3.7	Configuration of GGA Message Sending for Reference Network Applications	511

22.4	ASCII Input	515
22.4.1	Overview	515
22.4.2	Configuration of an ASCII Input Interface	516
22.4.3	Configuration of Annotations	518
22.4.4	Configuration of a Command to the Device	520
22.4.5	Working Example 1	521
22.4.6	Working Example 2	524
22.5	NMEA Out	527
22.6	Export Job	535
22.7	Hidden Point	538
22.8	Tilt	546
22.9	Meteo	550
22.10	SmartAntenna	551
22.11	Internet	554
22.12	PPS Output	558
22.13	Event Input	561
22.14	External Oscillator	564
22.15	ASCII Remote	567
22.16	Remote	570
23	Configuration of Devices	574
23.1	Devices	574
23.1.1	Overview	574
23.1.2	Digital Cellular Phones	575
23.1.3	Modems	578
23.1.4	Radios	580
23.1.5	RS232	582
23.1.6	SMARTgate	583
23.1.7	Hidden Point Measurement Devices	584

	23.1.8	GPRS / Internet Devices	586
23.2		Accessing CONFIGURE Devices / CONFIGURE GPRS Internet Devices	588
23.3		Creating a New Device	591
23.4		Editing a Device	595
24		Config...Interfaces... - Controlling Devices	596
24.1		Digital Cellular Phones	596
	24.1.1	Overview	596
	24.1.2	Configuring a GSM Connection	598
	24.1.3	Configuring a CDMA Connection	601
24.2		Modems	604
24.3		Radios	606
24.4		RS232	609
24.5		SMARTgate Boxes	611
24.6		Hidden Point Measurement Devices	613
24.7		GPRS / Internet Devices	615
24.8		Internet / Ethernet	617
24.9		Scanning Reference Stations	621
24.10		Configuring the Stations to Dial	623
	24.10.1	Overview	623
	24.10.2	Accessing CONFIGURE Stations to Dial	624
	24.10.3	Creating a New Station to Dial	626
	24.10.4	Editing a Station to Dial	628
24.11		Configuring the Server to Connect	629
	24.11.1	Overview	629
	24.11.2	Accessing CONFIGURE Server to Connect	630
	24.11.3	Creating a New Server	632
	24.11.4	Editing a Server to Connect	633

25	Tools...\Format Memory Device	634
26	Tools...\Transfer Objects...	636
27	Tools...\Upload System Files...	640
27.1	Application Programs	640
27.2	System Languages	642
27.3	Instrument Firmware	644
28	Tools...\Calculator	646
28.1	Overview	646
28.2	Accessing the Calculator	647
28.3	Configuring the Calculator	648
28.4	Using the Calculator	650
28.4.1	RPN Mode	650
28.4.2	Standard Mode	653
28.4.3	Description of Softkeys	656
28.4.4	Calling and Closing the Calculator from an Input Field for Numeric Characters	661
29	Tools...\File Viewer	664
30	Tools...\Licence Keys	668
31	STATUS	672
31.1	STATUS Functions	672
31.2	STATUS: Survey...	674
31.2.1	Satellite Status	674
31.2.2	Real-Time Status	679

	31.2.3	Current Position	690
	31.2.4	Logging Status	694
	31.2.5	Occupation Information Status	699
31.3		STATUS: Battery & Memory	702
31.4		STATUS: System Information	706
31.5		STATUS: Interfaces...	708
	31.5.1	Real-Time Input	708
	31.5.2	ASCII Input	709
	31.5.3	Tilt	711
	31.5.4	Meteo	713
	31.5.5	SmartAntenna	714
	31.5.6	Internet	715
	31.5.7	Event Input	716
	31.5.8	Remote Interfaces	718
31.6		Bluetooth	720
32		MapView Interactive Display Feature	722
	32.1	Overview	722
	32.2	Accessing MapView	724
	32.3	Configuring MapView	727
	32.4	MapView Components	732
	32.4.1	Softkeys	732
	32.4.2	Screen Area	734
	32.4.3	Toolbar	736
	32.4.4	Point Symbols	737
32.5		Map Mode	738
	32.5.1	MapView in Map Mode	738
	32.5.2	Selecting Points, Lines and Areas	740
32.6		Plot Mode - MapView Screen Area	744

32.7	Survey Mode	749
32.7.1	MapView in Survey Mode	749
32.7.2	MapView in Staking Out Survey Mode	751
32.7.3	Selecting Lines and Areas	754
33	Update Setups	756
33.1	Terminology	756
33.2	Procedure of Updating Setups	758
34	NTRIP via Internet	762
34.1	Overview	762
34.2	Configuring a Real-Time Rover for Using NTRIP Service	766
34.2.1	Configuring an Access to the Internet	766
34.2.2	Configuring to Connect to a Server	769
34.2.3	Using the NTRIP Service with a Real-Time Rover	772
34.3	Configuring a GRX1200 Pro/GRX1200 GG Pro for Connecting a NTRIP Server	775
35	Reference Station	780
36	Application Programs - General	782
36.1	Overview	782
36.2	Accessing the Application Programs Menu	784
37	COGO	786
37.1	Overview	786
37.2	Accessing COGO	788
37.3	Configuring COGO	797

37.4	COGO Calculation - Inverse Method	803
37.4.1	Inverse Point - Point	803
37.4.2	Inverse Point - Line	807
37.4.3	Inverse Point - Arc	813
37.4.4	Inverse Point - Current Position	820
37.5	COGO Calculation - Traverse Method	824
37.5.1	Overview	824
37.5.2	Traverse with Azimuth/Bearing	827
37.5.3	Traverse with Angle Right	832
37.6	COGO Calculation - Intersections Method	834
37.6.1	Intersection with Bearing - Bearing	834
37.6.2	Intersection with Bearing - Distance	840
37.6.3	Intersection with Distance - Distance	845
37.6.4	Intersection with By Points	848
37.6.5	Intersection with TPS Observation - TPS Observation	853
37.7	COGO Calculation - Line Calculations Method	857
37.7.1	Line Calculation - Base Point	857
37.7.2	Line Calculation - Offset Point	864
37.7.3	Line Calculation - Segmentation	866
37.8	COGO Calculation - Arc Calculations Method	870
37.8.1	Arc Calculation - Arc Center	870
37.8.2	Arc Calculation - Base Point	876
37.8.3	Arc Calculation - Offset Point	879
37.8.4	Arc Calculation - Segmentation	881
37.9	COGO Calculation - Shift, Rotate & Scale (Manual) Method	882
37.10	COGO Calculation - Shift, Rotate & Scale (Match Pts) Method	896
37.11	COGO Calculation - Area Division	902
37.11.1	Overview	902
37.11.2	Choosing an Area to be Divided	909

	37.11.3	Dividing an Area	914
	37.11.4	Results of the Area Division	918
	37.11.5	Working Example	921
	37.12	Selecting a Result from Previous COGO Inverse Calculations	925
	37.13	Modifying Values for Azimuths, Distances and Offsets	927
38		Determine Coordinate System - General	932
	38.1	Overview	932
	38.2	Accessing Determine Coordinate System	944
	38.3	Configuring Determine Coordinate System	947
	38.3.1	Configuring Determine Coordinate System - Normal	947
	38.3.2	Configuring Determine Coordinate System - One Point Localisation	953
39		Determine Coordinate System - Normal	960
	39.1	Overview	960
	39.2	Determining a New Coordinate System	961
	39.3	Updating a Coordinate System	974
	39.4	Matching Points	975
	39.4.1	Overview	975
	39.4.2	Selecting a New Pair of Matching Points	976
	39.4.3	Editing a Pair of Matching Points	977
	39.5	Transformation Results	978
	39.5.1	Accessing Transformation Results	978
	39.5.2	Results for Onestep and Twostep Transformations	979
	39.5.3	Results for Classic 3D Transformation	981

40	Determine Coordinate System - One Point Localisation	984
40.1	Accessing Determine Coordinate System - One Point Localisation	984
40.2	Determine Coordinate System - Onestep Transformation	986
40.3	Determine Coordinate System - Twostep Transformation	998
40.3.1	Twostep Transformation	998
40.3.2	Computing the Grid Scale Factor	1011
40.3.3	Computing the Height Scale Factor	1013
40.4	Determine Coordinate System - Classic 3D Transformation	1016
40.5	Computing Required Azimuth	1020
41	Reference Line	1022
41.1	Overview	1022
41.2	Accessing Reference Line	1027
41.3	Configuring Reference Line	1030
41.4	Managing Reference Lines/Arcs	1038
41.4.1	Overview	1038
41.4.2	Manually Entering a Reference Line/Arc	1039
41.4.3	Selecting a Reference Line/Arc from the Job	1045
41.4.4	Defining Reference Line/Arc Offsets	1052
41.4.5	Defining Reference Line/Arc Slopes	1056
41.5	Measuring to a Reference Line/Arc	1059
41.5.1	Measure Points	1059
41.5.2	Working Example	1069
41.6	Staking to a Reference Line/Arc	1073
41.6.1	Stakeout Points	1073
41.6.2	Working Example	1085
41.7	Gridstaking to a Reference Line/Arc	1089
41.7.1	Gridstaking Points	1089

	41.7.2 Working Example	1097
42	Reference Plane	1102
	42.1 Overview	1102
	42.2 Accessing Reference Plane	1106
	42.3 Configuring Reference Plane	1109
	42.4 Managing Reference Planes	1113
	42.5 Measuring Points to a Reference Plane	1121
43	Stakeout	1124
	43.1 Overview	1124
	43.2 Accessing Stakeout	1127
	43.3 Configuring Stakeout	1130
	43.4 Staking Out	1138
	43.4.1 Elements of the Graphical Display in the Stakeout	1138
	43.4.2 Staking Out in Orthogonal Mode	1140
	43.4.3 Staking Out in Polar Mode	1150
	43.4.4 Staking Out a DTM	1154
	43.4.5 Stakeout Difference Limit Exceeded	1158
44	Survey - General	1162
	44.1 Accessing Survey	1162
	44.2 GPS Surveying Techniques	1166
	44.3 Surveying Points	1170
	44.3.1 Post-Processed Kinematic and Static Operations	1170
	44.3.2 Real-Time Reference Operations	1175
	44.3.3 Real-Time Rover Operations	1185
	44.4 Adding Annotations for All Types of Operations	1190
	44.5 Timed Occupations for All Types of Operations	1192

44.6	Initialisation for Real-Time Rover Operations	1195
44.6.1	Terminology	1195
44.6.2	Accessing Initialisation for Real-Time Rover Operations	1197
44.6.3	Initialise while Moving	1199
44.6.4	Initialise while Static	1200
44.6.5	Initialise on Known Point	1202
45	Survey - Auto Points	1204
<hr/>		
45.1	Overview	1204
45.2	Configuring Auto Points	1206
45.3	Auto Points for Post-Processed Kinematic and Real-Time Rover Operations	1214
45.4	Offset Points of Auto Points	1219
45.4.1	Overview	1219
45.4.2	Configuring Offset Points	1222
45.4.3	Working Example	1227
46	Survey - Hidden Points	1232
<hr/>		
46.1	Overview	1232
46.2	Accessing Hidden Point Measurement	1235
46.3	Measuring Hidden Points	1237
46.3.1	Bearing & Distance	1237
46.3.2	Double Bearing	1242
46.3.3	Double Distance	1247
46.3.4	Chainage & Offset	1253
46.3.5	Backwards Bearing & Distance	1259
46.4	Computing an Azimuth	1261
46.4.1	Using the Sun	1261
46.4.2	Using Auxiliary Point	1263

46.5	Computing Horizontal Distances from Slope Distances	1266
46.6	Hidden Point Measurement Including Heights	1269
47	Survey Cross Section	1274
47.1	Overview	1274
47.2	Accessing Survey Cross Section	1277
47.3	Configuring Survey Cross Section	1280
47.4	Surveying Cross Sections	1283
47.5	Cross Section Templates	1289
	47.5.1 Accessing Cross Section Template Management	1289
	47.5.2 Creating a New Cross Section Template	1292
	47.5.3 Editing a Cross Section Template	1298
47.6	Working Example	1299
48	Volume Calculations	1304
48.1	Overview	1304
48.2	Accessing Volumes Calculations	1306
48.3	Configuring Volume Calculations	1310
48.4	Calculating Volumes	1312
	48.4.1 Survey Points	1312
	48.4.2 Triangulate Surfaces	1316
	48.4.3 Compute Volumes	1322
49	Wake-Up	1326
49.1	Overview	1326
49.2	Creating a New Wake-Up Session	1329
49.3	Editing a Wake-Up Session	1333
Appendix A	Menu Tree	1334

Appendix B	Memory Types	1338
Appendix C	Directory Structure of the Memory Device	1340
Appendix D	Pin Assignments and Sockets	1342
D.1	Receiver	1342
D.2	SmartAntenna	1349
D.3	RX1250	1351
Appendix E	Cables	1354
Appendix F	NMEA Message Formats	1360
F.1	Overview	1360
F.2	Used symbols for describing the NMEA formats	1361
F.3	GGA - Global Positioning System Fix Data	1366
F.4	GGK - Real-Time Position with DOP	1368
F.5	GGK(PT) - Real-Time Position with DOP, Trimble Proprietary	1370
F.6	GGQ - Real-Time Position with CQ	1372
F.7	GLL - Geographic Position Latitude/Longitude	1374
F.8	GNS - GNSS Fix Data	1376
F.9	GSA - GNSS DOP and Active Satellites	1378
F.10	GSV - GNSS Satellites in View	1380
F.11	LLK - Leica Local Position and GDOP	1382
F.12	LLQ - Leica Local Position and Quality	1384
F.13	RMC - Recommended Minimum Specific GNSS Data	1386
F.14	VTG - Course Over Ground and Ground Speed	1388
F.15	ZDA - Time and Date	1390

Appendix G	Event Input Notify Message Format	1392
Appendix H	Seismic Record Format	1394
Appendix I	PPS Output Notify Message Format	1396
Appendix J	AT Commands	1398
Index		1400

1 Equipment Setup

1.1 Receiver Ports

Description

All receiver ports of GPS1200 are part of the receiver front panel.

Ports on the receiver front panel

GX1210, GX1220, GX1220 GG, GX1230, GX1230 GG, GX1200 with PPS/Event option, GRX1200 Classic and GRX1200 Lite

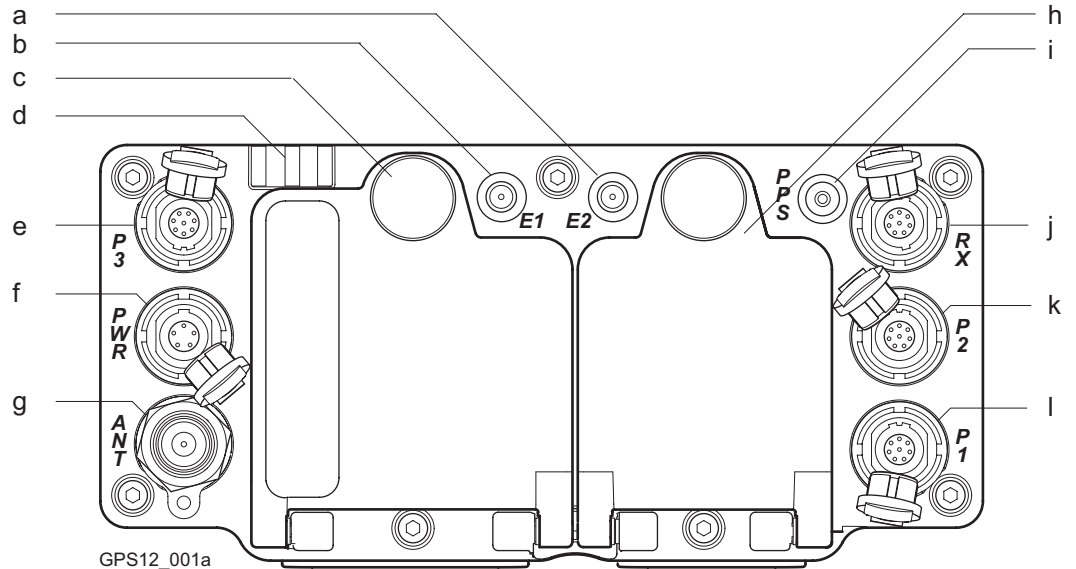

- | | |
|---|--|
| a) Port E2: Event input 2, on GX1200 with PPS/Event option | h) Port ANT: GNSS antenna in. |
| b) Port E1: Event input 1, on GX1200 with PPS/Event option | i) Battery compartment B, not for GRX1200 Pro/GRX1200 GG Pro |
| c) Battery compartment A with CompactFlash card compartment | j) Port PPS: PPS output, on GX1200 with PPS/Event option |
| d) LED indicators | k) Port RX: RX1200 in/out or remote interface in/out. 8 pin LEMO |

- e) Port P3: Power out,
- f) data in/out, or remote interface in/out. 8 pin LEMO
- g) Port PWR: Power in. 5 pin LEMO
- h) Port P2: Power out, data in/out, or remote interface in/out. 8 pin LEMO
- i) Port P1: Power out, data in/out, or remote interface in/out. 8 pin LEMO

GRX1200 Pro/GRX1200 GG Pro

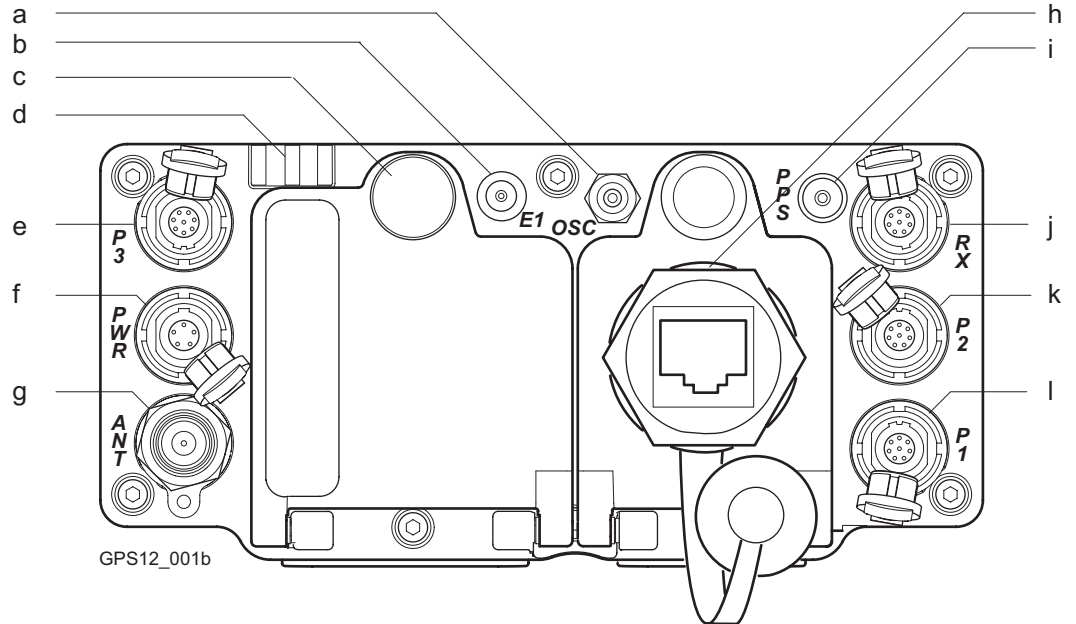

- a) Port OSC: External oscillator, in
- b) Port E1: Event input
- c) Battery compartment with CompactFlash card compartment
- d) LED indicators
- e) Port P3: Power out, data in/out, or remote interface in/out. 8 pin LEMO
- f) Port PWR: Power in. 5 pin LEMO
- g) Port ANT: GNSS antenna in
- h) Port NET: Ethernet/LAN data in/out, or remote interface.
- i) Port PPS: PPS output
- j) Port RX: RX1200 in/out or remote interface in/out. 8 pin LEMO
- k) Port P2: Power out, data in/out, or remote interface in/out. 8 pin LEMO
- l) Port P1: Power out, data in/out, or remote interface in/out. 8 pin LEMO

Cables

Refer to "Appendix E Cables" for information on cables.

Ports to connect equipment

Equipment	Port
RX1210 without cable	Direct clip on the receiver
RX1210 using a cable	Port RX
GNSS antenna	Port ANT
Radio in a housing, without cable	Port P1 or port P3
Radio without housing, using a cable	Port P1, port P2 or port P3
Radio in a housing of System 500, using a cable	Port P1, port P2 or port P3
External power	Port PWR

1.2

Post-Processed Static Reference on Pillar

Use

The equipment setup described below is to be used for static operations on fixed surveying pillars.

Description

The receiver and the RX1200 if used can be assembled to make one unit. One connection is needed to connect the GNSS antenna which is mounted on the pillar to the receiver. The receiver and the RX1200 can be kept in the container. Note that the receiver can be programmed with the RX1200 prior to use which can then be omitted from the setup.



- GNSS antenna is mounted directly using screw fitting. If using stub and adapter, procedures may vary slightly.
 - GNSS antennas are AX1201 or AX1202 GG. Procedures may vary if AT504/AT504 GG is used.
-

Equipment setup

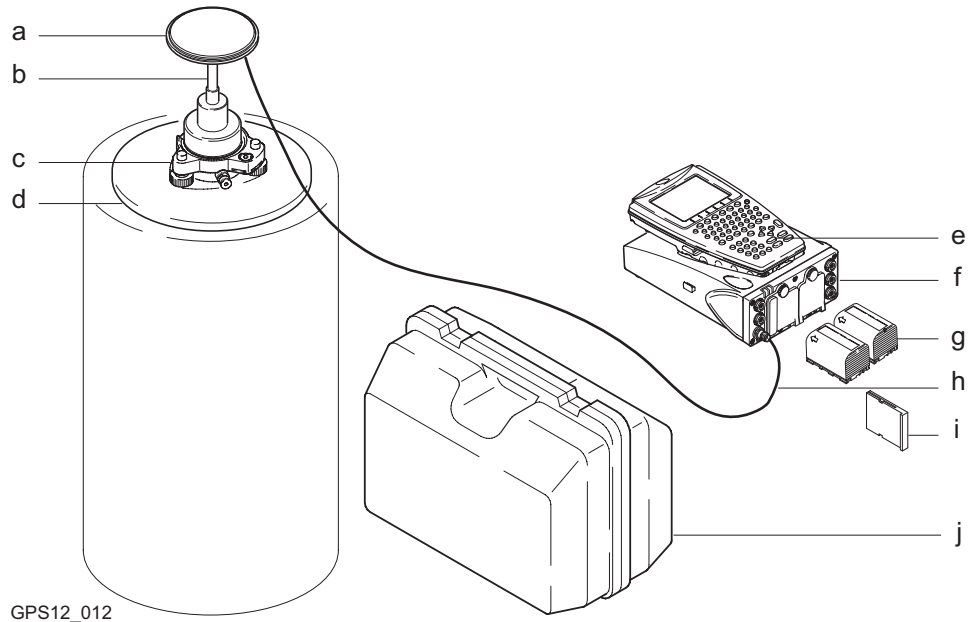

- a) GNSS antenna
AX1201/AX1202 GG/AT504/AT504 GG
- b) Carrier
- c) Tribrach
- d) Pillar plate if required
- e) RX1210 if required
- f) Receiver GX1210/GX1220/GX1220 GG/
GX1230/GX1230 GG
- g) Two batteries
- h) 2.8 m antenna cable
- i) CompactFlash card
- j) Transport container

Equipment setup step-by-step

Step	Description
1.	If a pillar plate is being used, locate the pillar plate on the pillar.
2.	Screw the tribrach to the pillar plate or the pillar.
3.	Level the tribrach.
4.	Place and lock the carrier in the tribrach.
5.	Screw the GNSS antenna onto the carrier.
6.	Check that the tribrach is still level.
7.	Insert the batteries into the receiver.
8.	Insert the CompactFlash card into the receiver.
9.	Connect the receiver to the GNSS antenna using the antenna cable and port ANT on the receiver.
10.	Attach the RX1210 to the receiver if required.
11.	Press the ON/OFF button on the receiver for at least 2 s or PROG on the RX1210 to switch the receiver on.
12.	Once operating, the receiver can be placed in the transport container for additional protection.

Next step

IF the receiver	AND the RX1200 is	Refer to chapter
has been pre-programmed	not being used	3
has been pre-programmed	being used	44
requires programming	being used	14



When using the adapter and carrier, ensure that the GNSS antenna and the adapter assembly slide down the full length of the carrier stub. An incorrectly mounted GNSS antenna will have a direct effect on the results.



If the receiver is left in the container during use in high temperatures, the lid should be left open. Refer to the GPS1200 User Manual for operating and storage temperatures.



Use an external battery such as GEB171 to ensure operation for a full day.

1.3 Post-Processed Static Reference on Tripod

Use The equipment setup described below is to be used for static operations over markers.

Description The receiver and the RX1200 if used can be assembled to make one unit. The receiver is either clipped to the tripod leg or is placed in the transport container. One connection is needed to connect the GNSS antenna to the receiver. Note that the receiver can be programmed with the RX1200 prior to use which can then be omitted from the setup.



- GNSS antenna is mounted directly using screw fitting. If using stub and adapter, procedures may vary slightly.
 - GNSS antennas are AX1201 or AX1202 GG. Procedures/setup may vary if AT504/AT504 GG is used.
-

Equipment setup

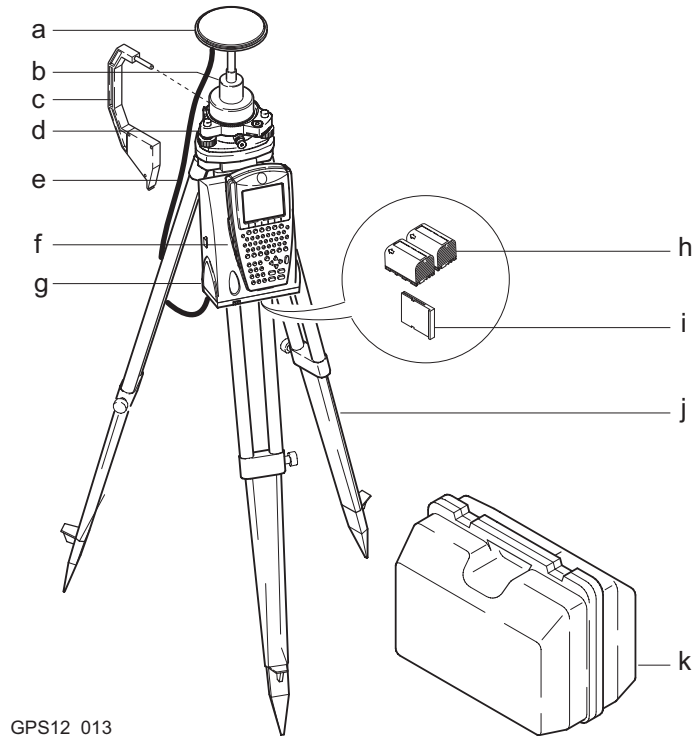

- a) GNSS antenna
AX1201/AX1202 GG
- b) Carrier
- c) Height hook

- g) Receiver GX1210/GX1220/GX1220 GG/
GX1230/GX1230 GG
- h) Two batteries
- i) CompactFlash card

- d) Tribrach
- e) 2.8 m antenna cable
- f) RX1210 if required
- j) Tripod
- k) Transport container

Equipment setup step-by-step

Step	Description
1.	Set up the tripod.
2.	Mount and level the tribrach on the tripod.
3.	Ensure that the tribrach is over the marker.
4.	Place and lock the carrier in the tribrach.
5.	Screw the GNSS antenna onto the carrier.
6.	Check that the tribrach is still level.
7.	Insert the batteries into the receiver.
8.	Insert the CompactFlash card into the receiver.
9.	Connect the receiver to the GNSS antenna using the antenna cable and port ANT on the receiver.
10.	Attach the RX1210 to the receiver if required.
11.	To hang the receiver on the tripod leg, use the hook on the rear of the unit. Or place the receiver in the transport container.
12.	Insert the height hook into the carrier.
13.	Measure the antenna height using the height hook.
14.	Press the ON/OFF button on the receiver for at least 2 s or PROG on the RX1210 to switch the receiver on.

Next step

IF the receiver	AND the RX1200 is	Refer to chapter
has been pre-programmed	not being used	3
has been pre-programmed	being used	44
requires programming	being used	14



When using the adapter and carrier, ensure that the GNSS antenna and the adapter assembly slide down the full length of the carrier stub. An incorrectly mounted GNSS antenna will have a direct effect on the results.



If the receiver is left in the container during use in high temperatures, the lid should be left open. Refer to the GPS1200 User Manual for operating and storage temperatures.



Use an external battery such as GEB171 to ensure operation for a full day.

1.4**Post-Processed Kinematic, Pole and Minipack**

Use

The equipment setup described below is to be used for post-processed kinematic rover surveys with extended periods of use in the field.

Description

The receiver is placed in the minipack. Connections are made to the GNSS antenna and the RX1200.



- GNSS antenna is mounted directly using screw fitting. If using stub and adapter, procedures may vary slightly.
 - Aluminium poles are used. They may be replaced with their carbon fibre equivalent without any change to these instructions.
-

Equipment setup

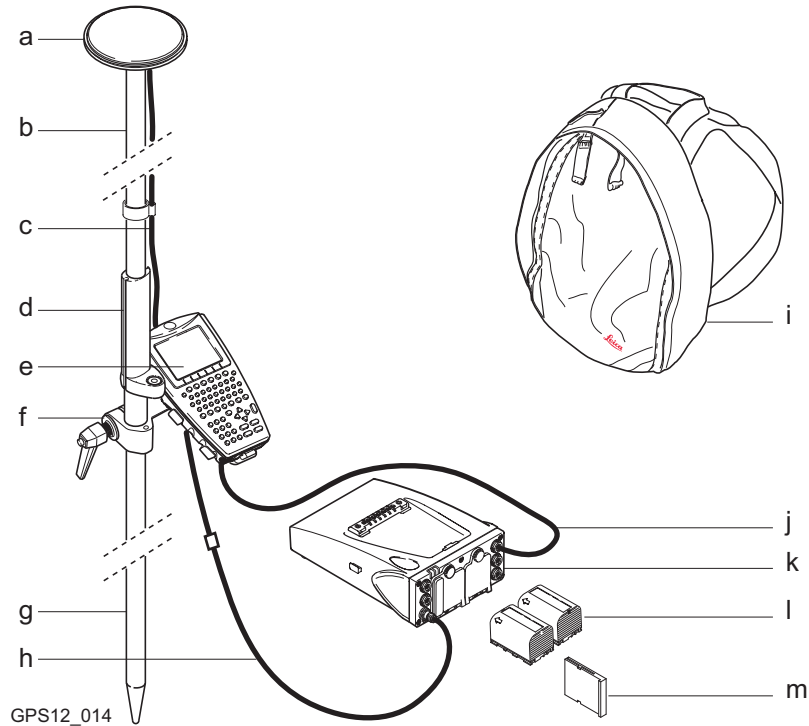

- a) GNSS antenna AX1201/AX1202 GG
- b) Upper half aluminium pole with screw
- c) 1.2 m antenna cable
- d) Grip for pole

- h) 1.6 m antenna cable
- i) Minipack
- j) 1.8 m, RX to GX cable
- k) Receiver GX1210/GX1220/GX1220 GG/
GX1230/GX1230 GG

- e) RX1210
- f) Holder for RX1210 on pole
- g) Lower half aluminium pole
- l) Two batteries
- m) CompactFlash card

Equipment setup step-by-step

Step	Description
1.	Screw the two halves of the pole together.
2.	Slide the grip onto the pole.
3.	Attach the RX1210 holder and tighten the screw.
4.	Screw the GNSS antenna to the top of the pole.
5.	Clip the RX1210 into the holder.
6.	Lock RX1210 to the holder by pushing up at the back of the red botton of the locking device.
7.	Insert the batteries into the receiver.
8.	Insert the CompactFlash card into the receiver.
9.	Place the receiver in the minipack with the top side facing outwards and the receiver front panel to the top.
10.	Fasten the strap around the receiver.
11.	Connect the 1.6 m antenna cable to port ANT on the receiver.
12.	Pass the 1.6 m antenna cable through a cable brake and down through the opening in the bottom corner of the minipack flap. Refer to paragraph "Position of cables in the minipack".
13.	Draw the required amount of cable out of the minipack and tighten the cable brake.

Step	Description
14.	Connect one end of the 1.2 m antenna cable to the loose end of the 1.6 m antenna cable and the other end to the GNSS antenna.
15.	Connect the 1.8 m, RX to GX cable to the RX1210.
16.	Pass the 1.8 m, RX to GX cable through the opening in the bottom corner of the minipack flap and up through a cable brake. Refer to paragraph "Position of cables in the minipack".
17.	Plug it into port RX on the receiver.
18.	Press PROG on the RX1210 to switch the receiver on.

Position of cables in the minipack

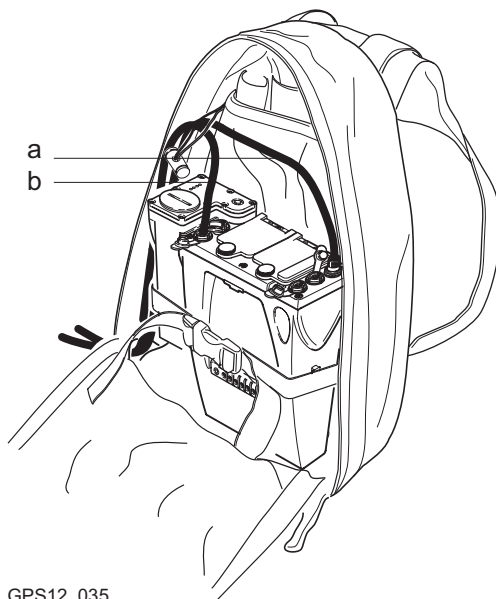

GPS12_035

- a) 1.6 m antenna cable
- b) 1.8 m, RX to GX cable to the RX1210

Next step

IF the receiver	And the RX1200 is	Refer to chapter
has been pre-programmed	being used	44
requires programming	being used	14



When using the upper pole half with stub, ensure that the GNSS antenna and the screw-to-stub adapter slide down the full length of the stub before tightening the locking ring. An incorrectly mounted GNSS antenna will have a direct effect on the results.



Refer to "1.15 Using the Minipack" for advice on using the minipack.

1.5

Post-Processed Kinematic, All-on-Pole - Option 1

Use

The equipment setup described below is to be used for post-processed kinematic rover surveys with short periods of use, especially where there are many obstacles such as fences.

Description

The RX1200 is fixed to the pole grip with a holder. With another holder, the receiver is fixed to the pole. One connection is needed to connect the GNSS antenna to the receiver. Another connection is needed to connect the RX1200 to the receiver.



- GNSS antenna is mounted directly using screw fitting. If using stub and adapter, procedures may vary slightly.
 - Aluminium poles are used. They may be replaced with their carbon fibre equivalent without any change to these instructions.
-

Equipment setup

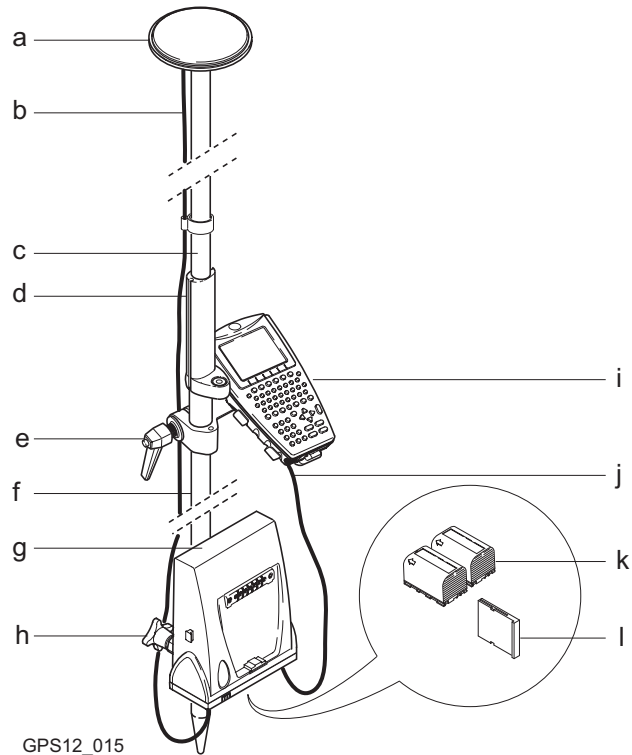

- a) GNSS antenna
AX1201/AX1202 GG
- b) 1.8 m antenna cable
- c) Upper half aluminium pole with screw

- g) Receiver GX1210/GX1220/GX1220 GG/
GX1230/GX1230 GG
- h) Holder for receiver on pole
- i) RX1210

- d) Grip for pole
- e) Holder for RX1210 on pole
- f) Lower half aluminium pole
- j) 1.0 m RX to GX cable
- k) Two batteries
- l) CompactFlash card

Equipment setup step-by-step

Step	Description
1.	Screw the two halves of the pole together.
2.	Slide the grip onto the pole.
3.	Attach the RX1210 holder and tighten the screw.
4.	Slide the holder piece for the receiver onto the pole.
5.	Attach the receiver holder and tighten the screw. The narrower end of the receiver holder faces upwards.
6.	Screw the GNSS antenna to the top of the pole.
7.	Clip the RX1210 into the holder.
8.	Lock RX1210 to the holder by pushing up at the back of the red bottom of the locking device.
9.	Insert the batteries into the receiver.
10.	Insert the CompactFlash card into the receiver.
11.	Connect the receiver to the GNSS antenna using the 1.8 m antenna cable and port ANT on the receiver.
12.	Connect the RX1210 to port RX on the receiver using the 1.0 m cable.
13.	Screw the receiver to the receiver holder with the receiver front panel facing downwards.
14.	Press PROG on the RX1210 to switch the receiver on.

Next step

IF the receiver	AND the RX1200 is	Refer to chapter
has been pre-programmed	being used	44
requires programming	being used	14



When using the upper pole half with stub, ensure that the GNSS antenna and the screw-to-stub adapter slide down the full length of the stub before tightening the locking ring. An incorrectly mounted GNSS antenna will have a direct effect on the results.

1.6

Post-Processed Kinematic, All-on-Pole - Option 2

Use

The equipment setup described below is to be used for post-processed kinematic rover surveys with short periods of use, especially where there are many obstacles such as fences.

Description

The RX1200, with the receiver attached, is fixed to the pole grip with a holder. One connection is needed to connect the GNSS antenna to the receiver.



- GNSS antenna is mounted directly using screw fitting. If using stub and adapter, procedures may vary slightly.
 - Aluminium poles are used. They may be replaced with their carbon fibre equivalent without any change to these instructions.
-

Equipment setup

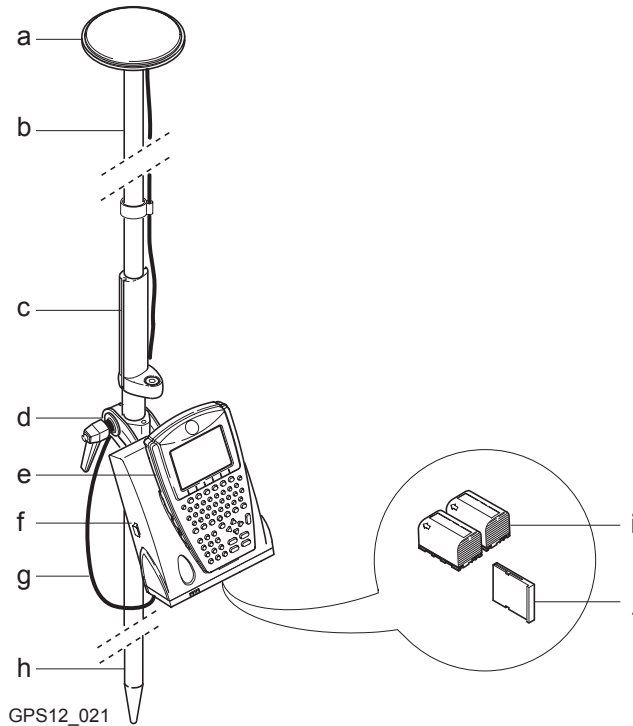

- a) GNSS antenna
AX1201/AX1202 GG
- b) Upper half aluminium pole with screw
- c) Grip for pole

- f) Receiver GX1210/GX1220/GX1220 GG/
GX1230/GX1230 GG
- g) 1.2 m antenna cable
- h) Lower half aluminium pole

- d) Holder for receiver together with RX1210 on pole
 e) RX1210
- i) Two batteries
 j) CompactFlash card

Equipment set-up step-by-step

Step	Description
1.	Screw the two halves of the pole together.
2.	Slide the grip onto the pole.
3.	Attach the holder for receiver together with RX1210 and tighten the screw.
4.	Screw the GNSS antenna to the top of the pole.
5.	Screw the receiver, with RX1210 attached, to the holder.
6.	Insert the batteries into the receiver.
7.	Insert the CompactFlash card into the receiver.
8.	Connect the receiver to the GNSS antenna using the 1.2 m antenna cable and port ANT on the receiver.
9.	Press PROG on the RX1210 to switch the receiver on.

Next step

IF the receiver	AND the RX1200 is	Refer to chapter
has been pre-programmed	being used	44
requires programming	being used	14



When using the upper pole half with stub, ensure that the GNSS antenna and the screw-to-stub adapter slide down the full length of the stub before tightening the locking ring. An incorrectly mounted GNSS antenna will have a direct effect on the results.

1.7

Real-Time Reference, Single Tripod

Use

The equipment setup described below is to be used for real-time reference stations with the need of normal radio coverage. Raw observation data may also be collected for post-processing.

Description

The receiver and RX1200 if used can be assembled to make one unit. The receiver clips to the tripod leg. Connections are made to the GNSS and radio antenna. The radio antenna is mounted on the antenna arm which clips to the GNSS antenna. Note that the receiver can be programmed with the RX1200 prior to use which can then be omitted from the setup. The GX1210, GX1220 and GX1220 GG can be used as a DGPS reference station if they are fitted with the DGPS option. They cannot be used as a real-time reference station.



- GNSS antenna is mounted directly using screw fitting. If using stub and adapter, procedures may vary slightly.
 - Standard radio mounted in radio housing is used throughout the instructions. Digital cellular phones may also be used but the setup may differ slightly.
-

Equipment setup

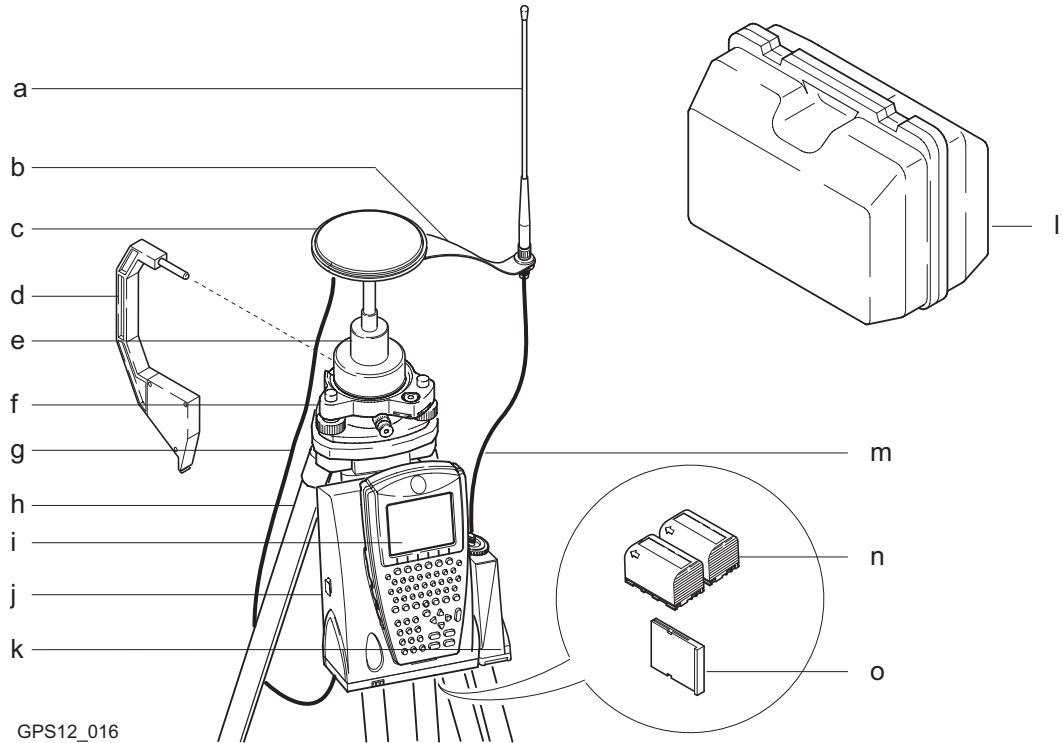

- a) Radio antenna
- b) Radio antenna arm 15 cm long
- c) GNSS antenna AX1201/AX1202 GG
- i) RX1210 if required
- j) Receiver GX1210/GX1220/GX1220 GG/GX1230/GX1230 GG
- k) Radio in housing

- d) Height hook
- e) Carrier
- f) Tribrach
- g) 1.2 m antenna cable to connect receiver and GNSS antenna
- h) Tripod
- l) Transport container
- m) 1.2 m antenna cable to connect radio housing to radio antenna
- n) Two batteries
- o) CompactFlash card

Equipment setup step-by-step

Step	Description
1.	Refer to "1.3 Post-Processed Static Reference on Tripod". Follow steps 1. to 13.
2.	Clip the antenna arm to the GNSS antenna.
3.	Screw the radio antenna onto the antenna arm.
4.	Attach the radio in its housing to port P1 or P3 on the receiver.
5.	Connect the radio antenna to the radio using the second 1.2 m antenna cable.
6.	Press the ON/OFF button on the receiver for at least 2 s or PROG on the RX1210 to switch the receiver on.

Next step

IF the receiver	AND the RX1200 is	Refer to chapter
has been pre-programmed	not being used	3
has been pre-programmed	being used	44
requires programming	being used	14



When using the adapter and carrier, ensure that the GNSS antenna and the adapter assembly slide down the full length of the carrier stub. An incorrectly mounted GNSS antenna will have a direct effect on the results.



If the receiver is left in the container during use in high temperatures, the lid should be left open. Refer to the GPS1200 User Manual for operating and storage temperatures.



Use an external battery such as GEB171 to ensure operation for a full day.

1.8

Real-Time Reference, Two Tripods

Use

The equipment setup described below is to be used for real-time reference station with the need of maximized radio coverage. Raw observation data may also be collected for post-processing.

Description

Refer to "1.7 Real-Time Reference, Single Tripod". The same description applies except that the radio antenna is mounted on the second tripod. This increases the height of the radio antenna and therefore maximizes radio coverage.



- GNSS antenna is mounted directly using screw fitting. If using stub and adapter, procedures may vary slightly.
 - Standard radio mounted in radio housing is used throughout the instructions. Digital cellular phones may also be used but the setup may differ slightly.
-

Equipment setup

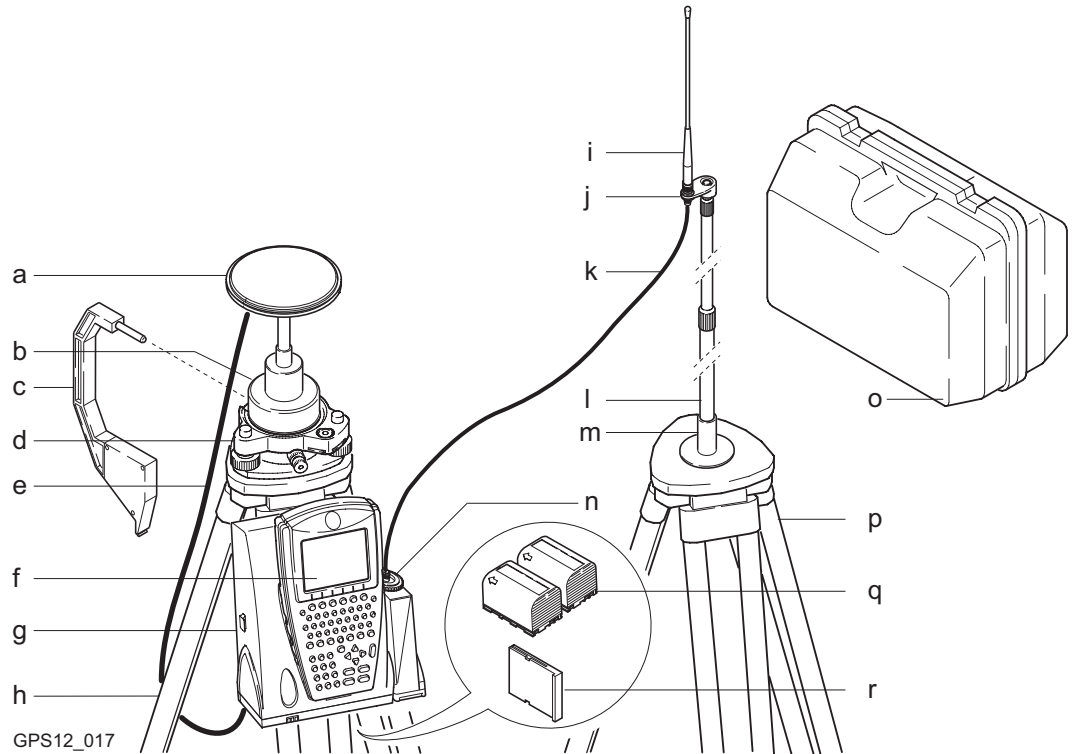

GPS12_017

- a) GNSS antenna AX1201/AX1202 GG
- b) Carrier
- c) Height hook
- d) Tribrach

- j) Radio antenna arm 3 cm long
- k) 2.8 m antenna cable
- l) Telescopic rod
- m) Base for telescopic rod

- e) 1.2 m antenna cable
- f) RX1210 if required
- g) Receiver GX1210/GX1220/GX1220 GG/
GX1230/GX1230 GG
- h) Tripod
- i) Radio antenna
- n) Radio in housing
- o) Transport container
- p) Tripod
- q) Two batteries
- r) CompactFlash card

Equipment setup step-by-step

Step	Description
1.	Refer to "1.3 Post-Processed Static Reference on Tripod". Follow steps 1. to 13.
2.	Attach the radio in its housing to port P1 or P3 on the receiver.
3.	Set up the second tripod nearby.
4.	Screw the base for the telescopic rod onto the tripod.
5.	Screw the radio antenna arm onto the telescopic rod.
6.	Screw the radio antenna onto the arm.
7.	Connect the radio antenna to the radio using the 2.8 m antenna cable.
8.	Push the telescopic rod into the base.
9.	Press the ON/OFF button on the receiver for at least 2 s or PROG on the RX1210 to switch the receiver on.

Next step

IF the receiver	AND the RX1200 is	Refer to chapter
has been pre-programmed	not being used	3
has been pre-programmed	being used	44
requires programming	being used	14



When using the adapter and carrier, ensure that the GNSS antenna and the adapter assembly slide down the full length of the carrier stub. An incorrectly mounted GNSS antenna will have a direct effect on the results.



If the receiver is left in the container during use in high temperatures, the lid should be left open. Refer to the GPS1200 User Manual for operating and storage temperatures.



Use an external battery such as GEB171 to ensure operation for a full day.

1.9 Real-Time Reference using SmartAntenna, RX1250 and GHT56

Use The equipment setup described below is to be used for real-time reference stations using SmartAntenna, RX1250 and GHT56. This setup is intended for surveys with the need of normal radio coverage. Raw observation data may also be collected for post-processing.

Description The RX1250, the radio housing for a device and the GHT56 can be assembled to make one unit. The GHT56 clips to the tripod leg. Connection between SmartAntenna and RX1250 is made via Bluetooth.



- GNSS antenna is mounted directly using screw fitting. If using stub and adapter, procedures may vary slightly.
 - Standard radio mounted in radio housing is used throughout the instructions. Digital cellular phones may also be used but the setup may differ slightly.
 - For extended operating times it is possible to power the SmartAntenna and the RX1250 simultaneously via an Y-cable with external battery.
-

Equipment setup

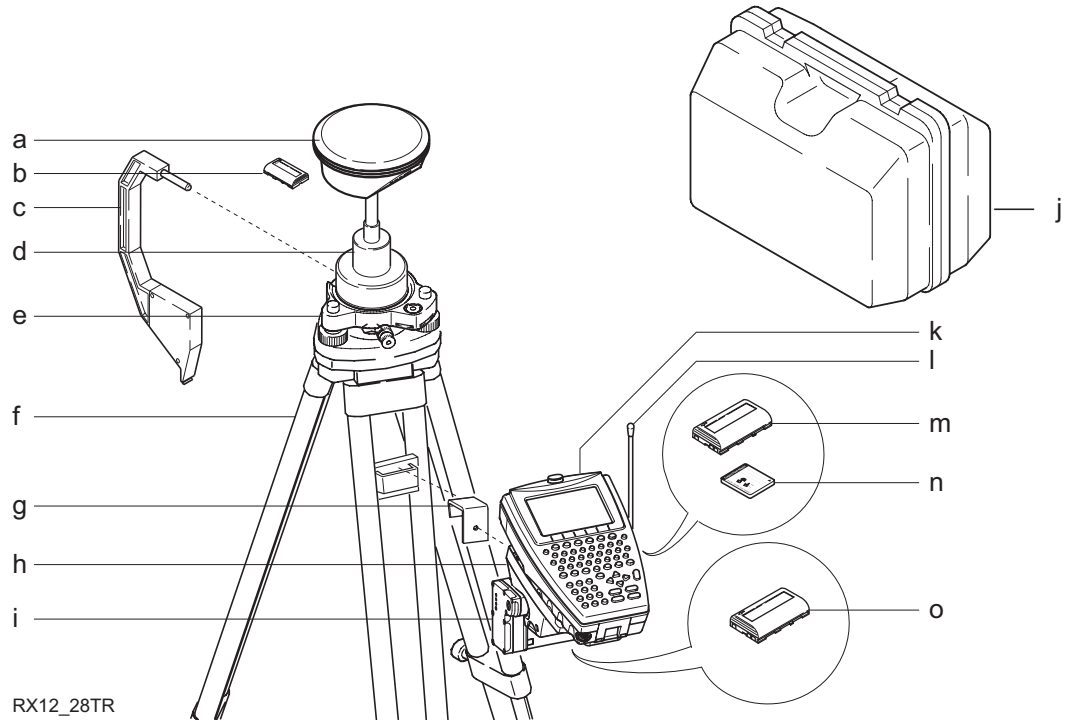

RX12_28TR

- a) SmartAntenna
- b) Battery for SmartAntenna
- c) Height hook
- d) Carrier
- e) Tribrach



- i) Radio housing
- j) Transport container
- k) RX1250
- l) Radio antenna
- m) Battery for RX1250

- f) Tripod
- g) GHT57
- h) GHT56

- n) CompactFlash card
- o) Battery for radio

Equipment setup step-by-step

Step	Description
1.	Set up the tripod.
2.	Mount and level the tribrach on the tripod.
3.	Ensure that the tribrach is over the marker.
4.	Place and lock the carrier in the tribrach.
5.	Insert the battery into the SmartAntenna.
6.	Screw the SmartAntenna onto the carrier.
7.	Check that the tribrach is still level.
8.	Insert the CompactFlash card into the RX1250.
9.	Insert the battery into the RX1250.
10.	Attach the RX1250 to the GHT56.
11.	Attach the radio in its housing to GHT56.
12.	Screw the 90° TNC connector onto the radio housing. The 90° TNC connector is delivered with the GHT56.
13.	Screw the radio antenna onto the 90° TNC connector.
14.	Make sure that the radio antenna is in an upright position.
15.	Place the battery into the battery compartment of the GHT56.

Step	Description
	To hang the GHT56 on the tripod leg, use the hook GHT57 delivered with the GHT56.
16.	Remove the mounting arm if attached to the GHT56. The mounting arm is used to mount RX1250 on a pole.
17.	Screw the GHT57 onto the back of the GHT56.
18.	Hang the GHT56 on the tripod leg.
19.	Measure the antenna height using the height hook.
20.	Press PROG on the RX1250 to switch on.
	RX1250 and SmartAntenna are connected via Bluetooth.

Next step

IF	Refer to chapter
the SmartAntenna interface has to be configured	22.10
the RX1250 has been pre-programmed	44
the RX1250 requires programming	14



When using the adapter and carrier, ensure that the GNSS antenna and the adapter assembly slide down the full length of the carrier stub. An incorrectly mounted GNSS antenna will have a direct effect on the results.

1.10

SmartRover - External Radio

Use

The equipment setup described below is to be used for real-time rover using SmartAntenna, RX1250X, GHT56 and an external radio.

Description

The RX1250X is fixed to the pole grip with the GHT56. The radio plus radio antenna attaches to the GHT56. Connection between the SmartAntenna and the RX1250X is made via Bluetooth.



- GNSS antenna is mounted directly using screw fitting. If using stub and adapter, procedures may vary slightly.
 - Aluminium poles are used. They may be replaced with their carbon fibre equivalent without any change to these instructions.
-

Equipment setup

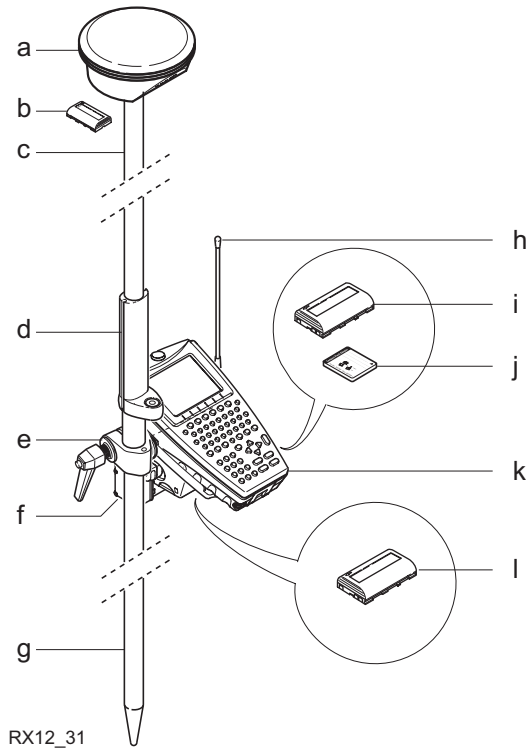

RX12_31

- | | |
|---|------------------------------|
| a) SmartAntenna | g) Lower half aluminium pole |
| b) Battery for SmartAntenna | h) Radio antenna |
| c) Upper half aluminium pole with screw or stub | i) Battery for RX1250X |
| d) Grip for pole | j) CompactFlash card |
| | l) Battery for RX1250X |

- e) GHT56
- f) Radio in housing

- k) RX1250X
- l) Battery for radio

Equipment setup step-by-step

Step	Description
1.	Screw the two halves of the pole together.
2.	Slide the grip onto the pole.
3.	Insert the battery into the SmartAntenna.
4.	Screw the SmartAntenna to the top of the pole.
5.	Insert the CompactFlash card into the RX1250X.
6.	Insert the battery into the RX1250X.
7.	Attach the RX1250X to the GHT56.
8.	Attach the radio in its housing to the GHT56.
9.	Screw the 90° TNC connector onto the radio housing. The 90° TNC connector is delivered with the GHT56.
10.	Screw the radio antenna onto the 90° TNC connector.
11.	Make sure that the radio antenna is in an upright position.
12.	Place the battery into the battery compartment of the GHT56.
13.	Attach the GHT56 and tighten the screw.
14.	Press PROG on the RX1250X to switch on.
	RX1250X and SmartAntenna are connected via Bluetooth.

Next step

IF	Refer to chapter
the SmartAntenna interface has to be configured	22.10
the RX1250X has been pre-programmed	44
the RX1250X requires programming	14



When using the upper pole half with stub, ensure that the GNSS antenna and the screw-to-stub adapter slide down the full length of the stub before tightening the locking ring. An incorrectly mounted GNSS antenna will have a direct effect on the results.

1.11

SmartRover - External Radio, Maximized Radio Coverage

Use

The equipment setup described below is to be used for real-time rover using SmartAntenna, RX1250X, GHT56 and an external radio. This setup is intended for surveys with the need of maximized radio coverage.

Description

The RX1250X is fixed to the pole grip with the GHT56. Connection between the SmartAntenna and the RX1250X is made via Bluetooth.
The radio attaches to the GHT56. The radio antenna is mounted on the antenna arm which clips to the SmartAntenna. This increases the height of the radio antenna and therefore maximizes radio coverage. Connection between the radio housing and the radio antenna is made via cable.



- GNSS antenna is mounted directly using screw fitting. If using stub and adapter, procedures may vary slightly.
 - Aluminium poles are used. They may be replaced with their carbon fibre equivalent without any change to these instructions.
-

Equipment setup

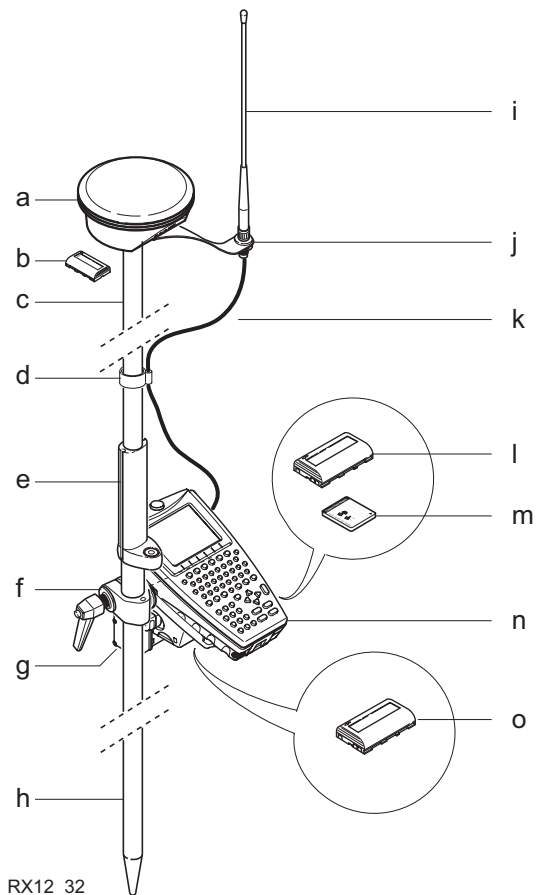

RX12_32

- a) SmartAntenna
- b) Battery for SmartAntenna
- c) Upper half aluminium pole with screw or stub
- d) Clip for cable
- e) Grip for pole
- f) GHT56
- g) Radio in housing
- h) Lower half aluminium pole
- i) Radio antenna
- j) Radio antenna arm 15 cm long
- k) 1.2 m antenna cable
- l) Battery for RX1250X
- m) CompactFlash card
- n) RX1250X
- o) Battery for radio

Equipment setup step-by-step

Step	Description
1.	Refer to "1.10 SmartRover - External Radio". Follow steps 1. to 4.
2.	Clip the antenna arm to the SmartAntenna.
3.	Screw the radio antenna onto the antenna arm.
4.	Insert the CompactFlash card into the RX1250X.
5.	Insert the battery into the RX1250X.
6.	Attach the RX1250X to the GHT56.
7.	Attach the radio in its housing to the GHT56.
8.	Place the battery into the battery compartment of the GHT56.
9.	Attach the GHT56 to the pole and tighten the screw.
10.	Connect the radio antenna to the radio housing using the 1.2 m antenna cable.
11.	Press PROG on the RX1250X to switch on.
	RX1250X and SmartAntenna are connected via Bluetooth.

Next step

IF	Refer to chapter
the SmartAntenna interface has to be configured	22.10
the RX1250X has been pre-programmed	44
the RX1250X requires programming	14



When using the upper pole half with stub, ensure that the GNSS antenna and the screw-to-stub adapter slide down the full length of the stub before tightening the locking ring. An incorrectly mounted GNSS antenna will have a direct effect on the results.

1.12

Real-Time Rover, Pole and Minipack

Use

The equipment setup described below is to be used for real-time rover with extended periods of use in the field. Raw observation data may also be collected for post-processing.

Description

The radio attaches to the receiver and is placed in the minipack. Connections are made to the GNSS antenna, radio antenna and RX1200. The cables coming from the minipack can be disconnected in the event that an obstacle such as a fence has to be crossed.



- GNSS antenna is mounted directly using screw fitting. If using stub and adapter, procedures may vary slightly.
 - Aluminium poles are used. They may be replaced with their carbon fibre equivalent without any change to these instructions.
 - Standard radio mounted in radio housing is used throughout the instructions. Digital cellular phones may also be used but the setup may differ slightly.
-

Equipment setup

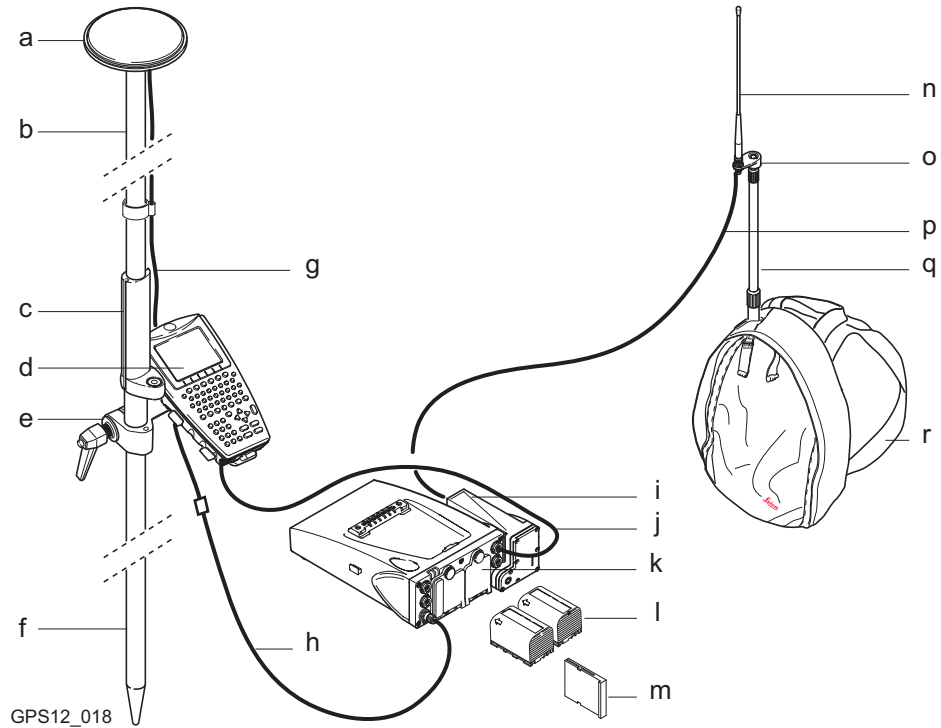

GPS12_018

- a) GNSS antenna AX1201/AX1202 GG
- b) Upper half aluminium pole with screw or stub
- c) Grip for pole
- j) 1.8 m, RX to GX cable
- k) Receiver GX1210/GX1220/GX1220 GG/GX1230/GX1230 GG
- l) Two batteries

- d) RX1210
- e) Holder for RX1210 on pole
- f) Lower half aluminium pole
- g) 1.2 m antenna cable
- h) 1.6 m antenna cable
- i) Radio in housing
- m) CompactFlash card
- n) Radio antenna
- o) Radio antenna arm 3 cm long
- p) 1.2 m antenna cable to connect radio housing and radio antenna
- q) Telescopic rod
- r) Minipack

Equipment setup step-by-step

Step	Description
1.	Refer to "1.4 Post-Processed Kinematic, Pole and Minipack". Follow steps 1. to 8.
2.	Attach the radio in its housing to port P1 or P3 on the receiver.
3.	Place the receiver in the minipack with the top side facing outwards and the receiver front panel to the top.
4.	Fasten the strap around the receiver.
5.	Push the telescopic rod through the slit in the top of the minipack. Ensure it is located in the sleeve inside the minipack and push it all the way to the bottom.
6.	Adjust the height of the telescopic rod to suit.
7.	Screw the radio antenna arm onto the telescopic rod.
8.	Connect the first 1.2 m antenna cable to the radio antenna.
9.	Pass the cable through the opening in the top of the minipack and down underneath the receiver.
10.	Connect the first 1.2 m antenna cable to the radio.
11.	Connect the 1.6 m antenna cable to port ANT on the receiver.

Step	Description
12.	Pass the 1.6 m antenna cable through a cable brake and down through the opening in the bottom corner of the minipack flap. Refer to paragraph "Position of cables in the minipack".
13.	Draw the required amount of cable out of the minipack and tighten the cable brake.
14.	Connect one end of the second 1.2 m antenna cable to the loose end of the 1.6 m antenna cable and the other end to the GNSS antenna.
15.	Connect the 1.8 m, RX to GX cable to the RX1210.
16.	Pass the 1.8 m, RX to GX cable through the opening in the bottom corner of the minipack flap and up through a cable brake. Refer to paragraph "Position of cables in the minipack".
17.	Plug it into port RX on the receiver.
18.	Press PROG on the RX1210 to switch the receiver on.

Position of cables in the minipack

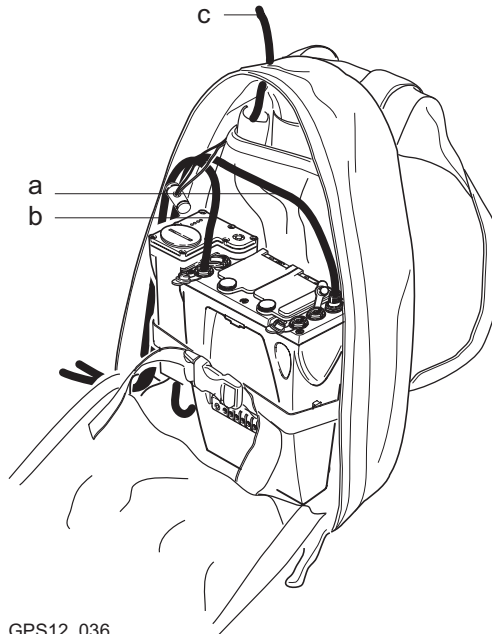

GPS12_036

- a) 1.6 m antenna cable
- b) 1.8 m, RX to GX cable
- c) 1.2 m antenna cable to connect radio housing and radio antenna

Next step

IF the receiver	AND the RX1200 is	Refer to chapter
has been pre-programmed	being used	44
requires programming	being used	14



When using the upper pole half with stub, ensure that the GNSS antenna and the screw-to-stub adapter slide down the full length of the stub before tightening the locking ring. An incorrectly mounted GNSS antenna will have a direct effect on the results.



Refer to "1.15 Using the Minipack" for advice on using the minipack.

1.13

Real-Time Rover, All-on-Pole - Option 1

Use The equipment setup described below is to be used for real-time rover with short periods of use, especially where there are many obstacles such as fences.

Description

The RX1200 is fixed to the pole grip with a holder. With another holder, the receiver is fixed to the pole. One connection is made from the receiver to the GNSS antenna. Another connection is made from the receiver to the RX1200. The radio plus radio antenna attaches to the receiver.



- GNSS antenna is mounted directly using screw fitting. If using stub and adapter, procedures may vary slightly.
 - Aluminium poles are used. They may be replaced with their carbon fibre equivalent without any change to these instructions.
 - Standard radio mounted in radio housing is used throughout the instructions. Digital cellular phones may also be used but the setup may differ slightly.
-

Equipment setup

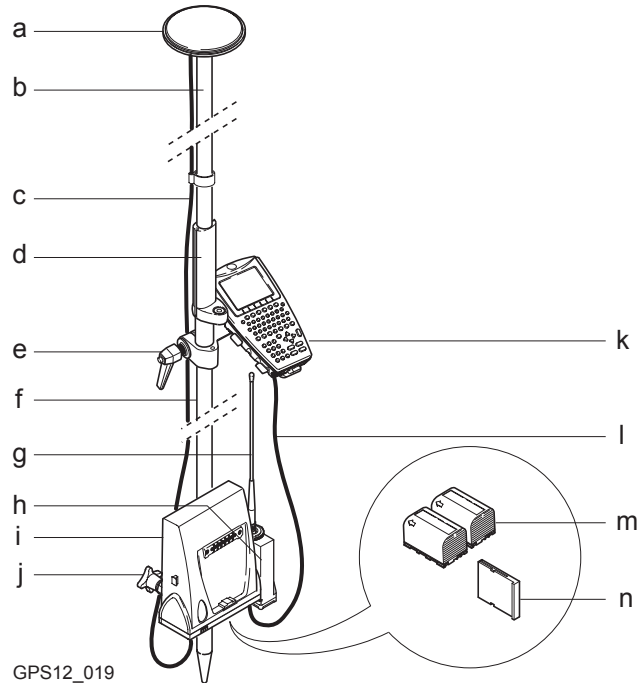

- a) GNSS antenna AX1201/AX1202 GG
- b) Upper half aluminium pole with screw
- c) 1.8 m antenna cable
- d) Grip for pole
- e) Holder for RX1210 on pole
- h) Radio in housing
- i) Receiver GX1210/GX1220/GX1220 GG/ GX1230/GX1230 GG
- j) Holder for receiver on pole
- k) RX1210
- l) 1.0 m RX to GX cable
- m) [Receiver module]
- n) [Receiver module]

- f) Lower half aluminium pole
- g) Radio antenna

- m) Two batteries
- n) CompactFlash card

Equipment setup step-by-step

Step	Description
1.	Refer to "1.5 Post-Processed Kinematic, All-on-Pole - Option 1". Follow steps 1. to 13.
2.	Attach the radio in its housing to port P1 or P3 on the receiver.
3.	Screw the radio antenna onto the housing.
4.	Press PROG on the RX1210 to switch the receiver on.

Next step

IF the receiver	AND the RX1200 is	Refer to chapter
has been pre-programmed	being used	44
requires programming	being used	14



When using the upper pole half with stub, ensure that the GNSS antenna and the screw-to-stub adapter slide down the full length of the stub before tightening the locking ring. An incorrectly mounted GNSS antenna will have a direct effect on the results.

1.14**Real-Time Rover, All-on-Pole - Option 2**

Use

The equipment setup described below is to be used for real-time rover with short periods of use, especially where there are many obstacles such as fences.

Description

The RX1200, with the receiver attached, is fixed to the pole grip with a holder. One connection is needed to connect the GNSS antenna to the receiver. The radio plus radio antenna attaches to the receiver.



- GNSS antenna is mounted directly using screw fitting. If using stub and adapter, procedures may vary slightly.
 - Aluminium poles are used. They may be replaced with their carbon fibre equivalent without any change to these instructions.
 - Standard radio mounted in radio housing is used throughout the instructions. Digital cellular phones may also be used but the setup may differ slightly.
-

Equipment setup

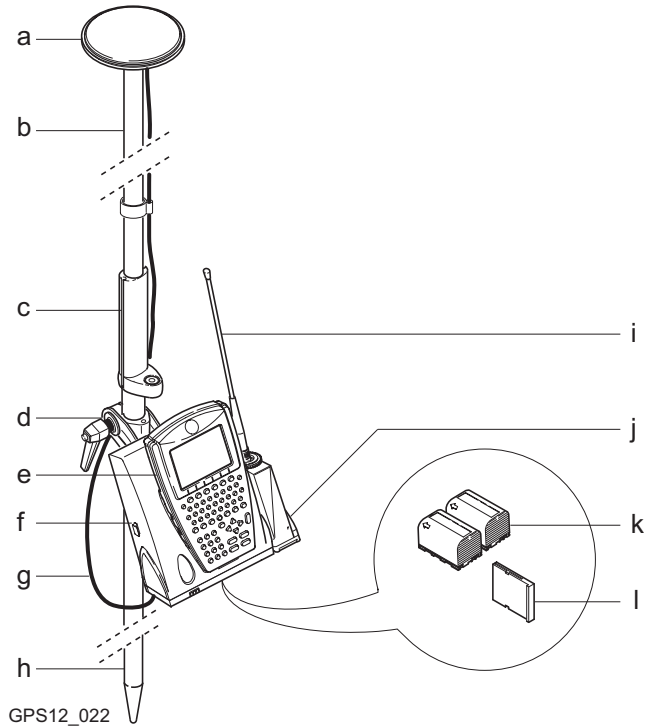

- GPS12_022
- a) GNSS antenna AX1201/AX1202 GG
 - b) Upper half aluminium pole with screw
 - c) Grip for pole
 - d) Holder for RX1210 and receiver on pole
 - e) RX1210

- g) 1.2 m antenna cable
- h) Lower half aluminium pole
- i) Radio antenna
- j) Radio in housing
- k) Two batteries

- f) Receiver GX1210/GX1220/GX1220 GG/ l) CompactFlash card
 GX1230/GX1230 GG

Equipment setup step-by-step

Step	Description
1.	Refer to "1.6 Post-Processed Kinematic, All-on-Pole - Option 2". Follow steps 1. to 8.
2.	Attach the radio in its housing to port P1 or P3 the receiver.
3.	Screw the radio antenna onto the housing.
4.	Press PROG on the RX1210 to switch the receiver on.

Next step

IF the receiver	AND the RX1200 is	Refer to chapter
has been pre-programmed	being used	44
requires programming	being used	14



When using the upper pole half with stub, ensure that the GNSS antenna and the screw-to-stub adapter slide down the full length of the stub before tightening the locking ring. An incorrectly mounted GNSS antenna will have a direct effect on the results.

1.15

Using the Minipack

Use

The minipack is used for various applications. The applications are:

- Post-processed kinematic, pole and minipack.
 - Real-time rover, pole and minipack.
-

Antenna pole strap

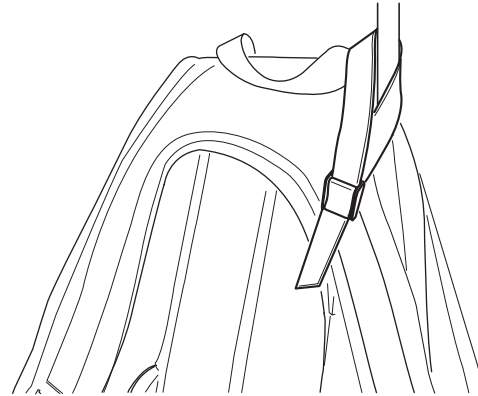

GPS12_137

Ensures the antenna pole does not sway around and remains as upright as possible.

Pass the strap around the pole and fasten using the clip as shown in the diagram.

Hip belt

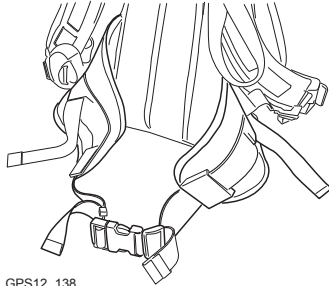

GPS12_138

The hip belt

- transfers most of the weight from the shoulders to the hips when properly adjusted.
- contains velcro attachments through which cables can be passed.

Internal net pouch



GPS12_139

The internal net pouch is designed for

- carrying an AX1201/AX1202 GG antenna when not in use.
- storing coiled cables.
- carrying a non standard radio.
- carrying spare batteries.
- carrying sandwiches.

Use in high temperatures

In high temperatures it is desirable to increase air flow around the receiver. Therefore the minipack can be kept half or even fully open when in use.



GPS12_140

To half open the minipack:

1. Open the minipack halfway.
2. Tuck the flap inside.
3. Secure it with the velcro pad.

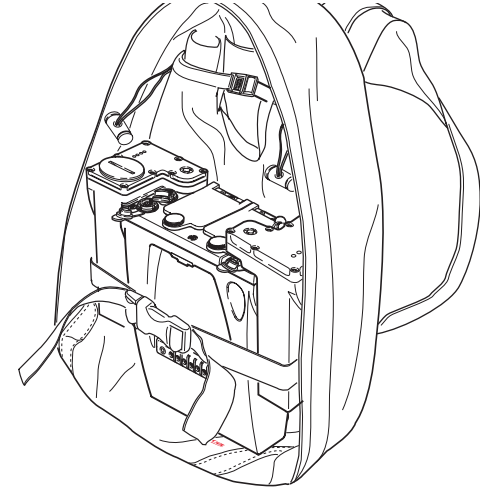

GPS12_141

To fully open the minipack:

1. Open the minipack completely.
2. Tuck the flap inside.
3. Secure it with the velcro pad.
4. Tuck the flap under the receiver.

1.16

Checking and Adjusting the Circular Level on the Tribrach

Description

The circular level is used to level the antenna over the observation point. An incorrectly adjusted circular level means that the GNSS antenna is not properly levelled over the point. This means that in fact another point on the ground is observed.

Tribrach should be checked and adjusted

- before the first use.
- before each precision survey.
- after long periods of transport.
- after long periods of work.
- if the temperature changes by more than 20°C.

Equipment checklist

- Tripod
- Carrier with precision bubble checked and adjusted
- Tribrach
- Adjusting pin

Check and adjust step-by-step

Step	Description
1.	Set up the tripod.
2.	Screw the tribrach onto the tripod.
3.	Fix the carrier to the tribrach.
4.	Level the tripod using the precision bubble on the carrier.
5.	Is the circular level on the tribrach centered and does not extend beyond the circle?

Step	Description
	<ul style="list-style-type: none"> • If yes, no adjustment is required. The procedure is finished. • If no, the bubble needs adjusting. Continue with step 6.
6.	Take down the carrier with precision bubble.
7.	Centre the bubble using the adjustment pin in conjunction with the adjustment screws on the bottom side of the bubble. Refer to paragraph "Diagram".
8.	Reattach the precision bubble to the tribrach.
9.	Check that no screw is loose.
10.	Check the adjustment of the circular level using the precision bubble.
11.	<p>Is more adjustment necessary?</p> <ul style="list-style-type: none"> • If no, the adjustment procedure is finished. • If yes, repeat steps 6. to 11.

Diagram

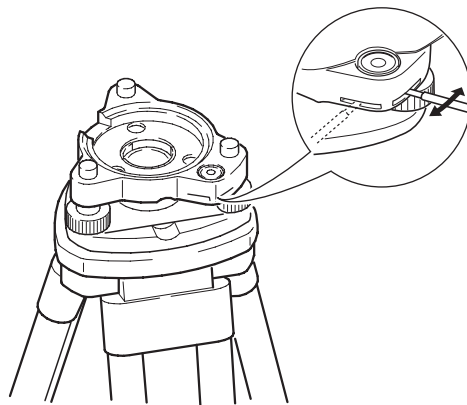

GPS12_61

2

Antenna Heights

2.1

Overview

Description

The height of the GNSS antenna above the point consists of three components:

- the vertical or slope height reading,
- the vertical offset,
- the vertical phase centre variations.

For most operations, pre-configured standard settings in the receiver can be used. They automatically take the vertical phase centre variations into account.

Vertical or slope height

GPS1200 accepts vertical and slope antenna heights measured to the **Mechanical Reference Plane**. For the majority of GNSS antennas, including all Leica GNSS antennas, the vertical antenna height is measured.

Measurements required

This is an overview of required measurements depending on antennas, setup and accessories.

IF the antenna is	AND the accessories are	AND the setup is	THEN the measurements required are
standard GPS1200/System 500	standard GPS1200/System 500	tripod	vertical height from height hook

IF the antenna is	AND the accessories are	AND the setup is	THEN the measurements required are
standard GPS1200/System 500	standard GPS1200/System 500	pole	none. Value is 2.00 m.
standard GPS1200/System 500	standard GPS1200	pillar	<ul style="list-style-type: none"> vertical height to the MRP. <p>Refer to "2.2 Mechanical Reference Planes, MRP".</p>
standard GPS1200/System 500	non Leica	any	<ul style="list-style-type: none"> vertical height to the MRP. possibly vertical offset. <p>Refer to "2.2 Mechanical Reference Planes, MRP"</p>
non Leica antenna	standard GPS1200/System 500 OR non Leica	any	<ul style="list-style-type: none"> vertical height to the MRP. possibly vertical offset.

IF the antenna is	AND the accessories are	AND the setup is	THEN the measurements required are
			<ul style="list-style-type: none"> • phase centre variations. • horizontal offset if a slope height reading. <p>Refer to "2.2 Mechanical Reference Planes, MRP"</p>

Vertical phase centre variations

For Leica antennas: Are handled automatically in the standard antenna records.

For non Leica antennas: Can be stored in a newly created antenna record.
OR
Antenna records including azimuth and elevation dependent corrections need to be created using LGO.

The antenna calibrations to determine the phase centre variations were executed by Geo++[®] GmbH.

2.2

Mechanical Reference Planes, MRP

General

The Mechanical Reference Plane

- is where the antenna heights are measured to.
- is where the phase centre variations refer to.
- varies for different antennas.

The MRP is shown for each GPS1200 antenna.

AX1201/AX1202 GG

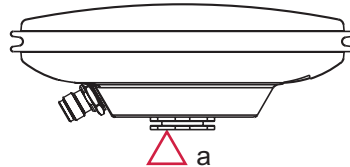

GPS12_028

- a) The mechanical reference plane is the underside of the threaded metal insert.
-

SmartAntenna

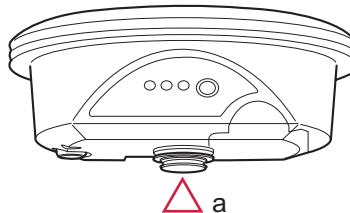

GPS12_154

- a) The mechanical reference plane is the underside of the threaded metal insert.
-

AT504/AT504 GG

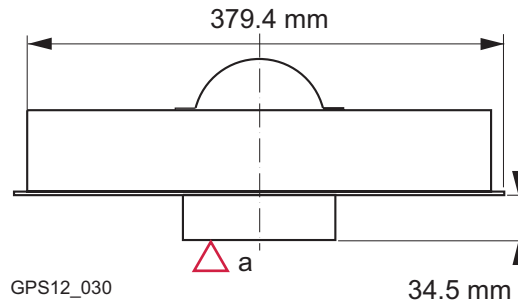

- a) The mechanical reference plane is the underside of the preamplifier housing. The AT504/AT504 GG is built to a JPL design specified by the IGS for reference stations.

2.3

2.3.1



Determining Antenna Heights

Pillar Setup

- One of the Leica standard antennas is used: AX1201, AX1202 GG, SmartAntenna, AT504, AT504 GG, AT501, AT502, AT503.
 - Leica standard accessories are used.
-

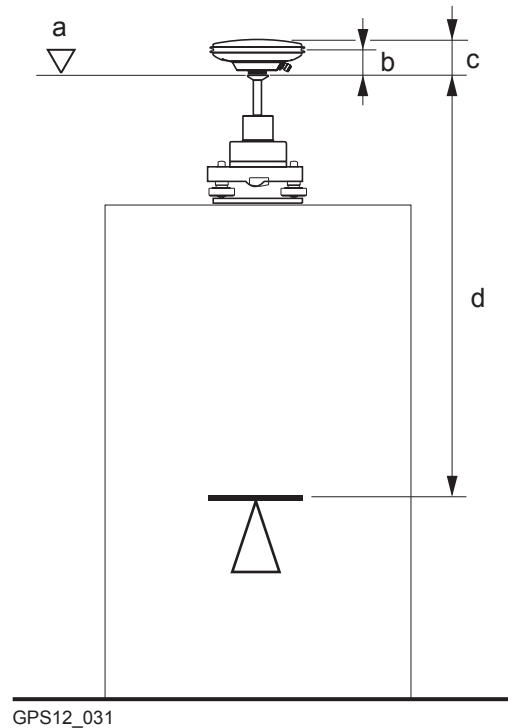
Pillar setup

- a) Mechanical reference plane
- b) Vertical phase centre offset for L1
- c) Vertical phase centre offset for L2
- d) Vertical height reading

An AX1201/AX1202 GG antenna is shown. Vertical offset = 0

Vertical height reading

The vertical height reading is the height difference between the pillar benchmark and the mechanical reference plane of the antenna. Normally, it is determined indirectly by levelling.

Determine the antenna height step-by-step

Sometimes, it is difficult to measure to the MRP directly.

Step	Description
1.	Determine the height difference between the pillar benchmark and a surface on the carrier.
2.	Refer to paragraph "Carrier and adapter dimensions". Look up the height difference between this surface on the carrier and where the MRP of the antenna sits on the carrier.
3.	Add the values determined in step 1. and 2., to get the vertical height reading .
4.	For Leica standard antennas plus accessories, the vertical offset is 0.00 m.

Carrier and adapter dimensions

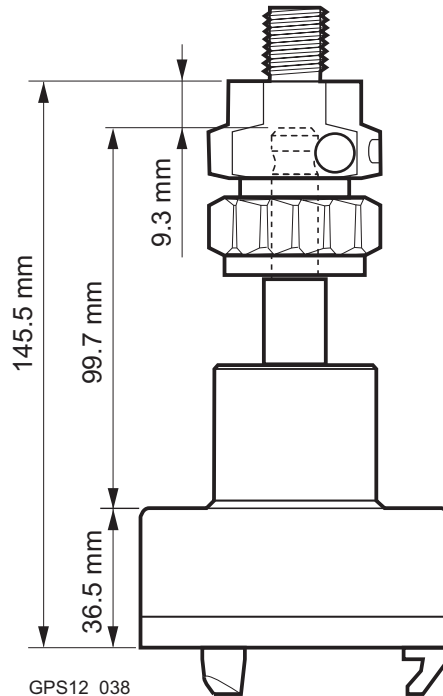

GRT144 carrier with GAD31 screw-to-stub adapter.

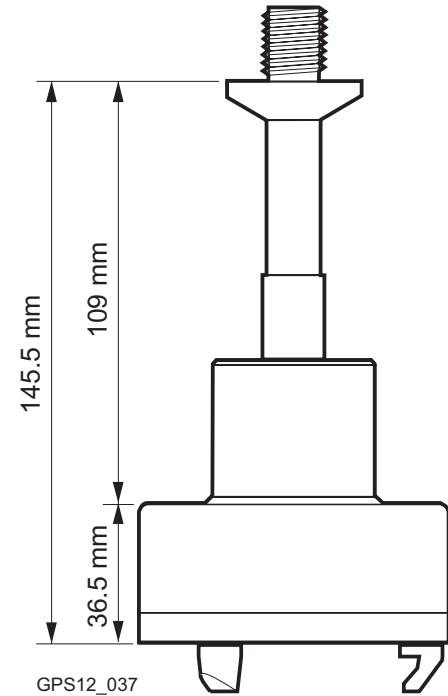

GRT146 carrier.

Next step

- At the beginning of a survey, enter the vertical height reading into the receiver.
- The vertical offset of 0.00 m is stored in the antenna setup record for a pillar setup and will automatically be taken into account.

- Refer to "2.1 Overview" for the vertical phase centre variations.



For carriers other than those shown in the diagram above, the dimensions must be determined.



Except for Leica standard antennas plus accessories, the vertical offset must be measured. This value must be entered in the antenna setup record.

2.3.2

Tripod Setup



- One of the Leica standard antennas is used: AX1201, AX1202 GG, SmartAntenna, AT504, AT504 GG, AT501, AT502, AT503.
 - Leica standard accessories are used.
-

Tripod setup

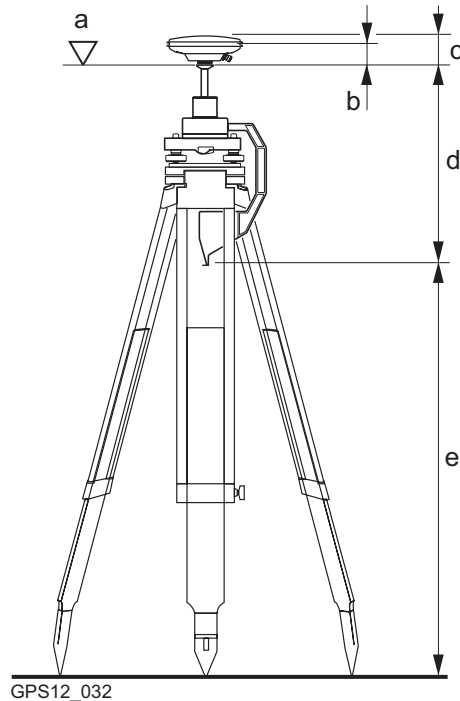

- a) Mechanical reference plane
- b) Vertical phase centre offset for L1
- c) Vertical phase centre offset for L2
- d) Vertical offset
- e) Vertical height reading

An AX1201/AX1202 GG antenna is shown.

Vertical height reading

The vertical height reading is the height difference between the ground mark and the bottom end of the height hook. It is determined using the height hook.

Determine the antenna height step-by-step

Step	Description
1.	Determine the vertical height reading using the height hook.
2.	For Leica standard antennas plus accessories, the vertical offset is 0.36 m.

Next step

- At the beginning of a survey, enter the vertical height reading into the receiver.
- The vertical offset of 0.36 m is stored in the antenna setup record for a tripod setup and will automatically be taken into account. It does not need to be entered.
- Refer to "2.1 Overview" for the vertical phase centre variations.



For other than the carriers shown in the diagram above, the dimensions must be determined and the vertical offset must be adapted.



For other height measurement devices than the height hook, the dimensions must be determined and the vertical offset must be adapted.



For other than Leica standard antennas, the vertical offset must be measured. It must be entered in the antenna setup record.

2.3.3

Pole Setup



- One of the Leica standard antennas is used: AX1201, AX1202 GG, SmartAntenna, AT502, AT503.
- Leica standard accessories are used.

Pole setup

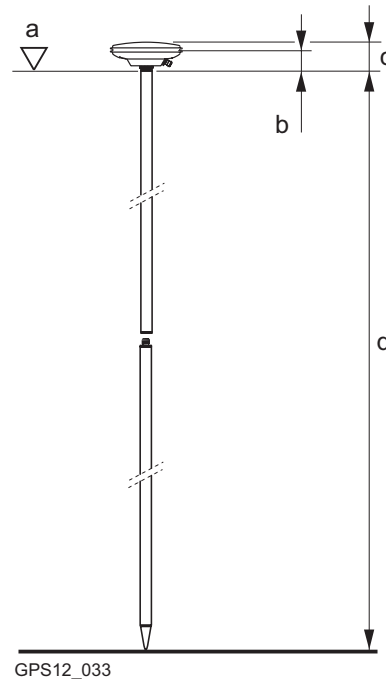

- a) Mechanical reference plane
- b) Vertical phase centre offset for L1
- c) Vertical phase centre offset for L2
- d) Vertical height reading

An AX1201/AX1202 GG antenna is shown. Vertical offset = 0

Vertical height reading

The vertical height reading is the height difference between the bottom end and the top end of the pole. Usually, this is a fixed value.

Determine the antenna height step-by-step

Step	Description
1.	The vertical height reading for <ul style="list-style-type: none"> • the Leica standard pole consisting of an upper and a lower half is 2.00 m. • the Leica standard pole consisting of an upper and a lower half with an additional 1.00 m pole section added is 3.00 m. • the lower half of the pole alone is 1.00 m.
2.	For Leica standard antennas plus accessories, the vertical offset is 0.00 m.

Next step

- At the beginning of a survey, enter the vertical height reading into the receiver. Note that a standard rover configuration with a standard antenna setup record for a pole setup uses the value of 2.00 m already as default.
- The vertical offset of 0.00 m is stored in the antenna setup record for a pole setup and will automatically be taken into account. It does not need to be entered.
- Refer to "2.1 Overview" for the vertical phase centre variations.



For other than the Leica standard poles, the dimensions must be determined.



For other than Leica standard antennas, the vertical offset must be measured. It must be entered in the antenna setup record.

2.4

Measuring Slope Antenna Heights

Setup with a slope
antenna height

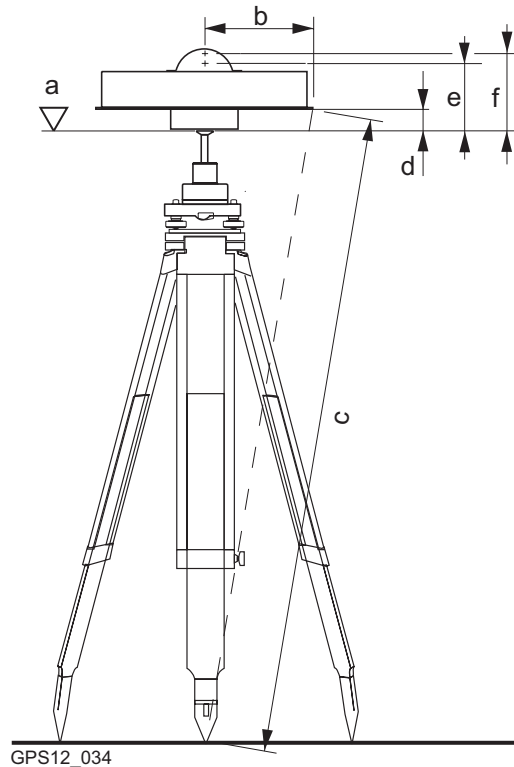

- a) Mechanical reference plane
- b) Horizontal offset
- c) Slope height reading
- d) Vertical offset
- e) Vertical phase centre offset for L1
- f) Vertical phase centre offset for L2

An AT504/AT504 GG antenna, Dorne Margolin T, as specified by the IGS is shown. The mechanical reference plane will differ depending on the antenna type used.

Determine the slope height reading

The slope height reading is the height difference between the ground marker and the outside edge of the antenna.

Next step

- Determine the horizontal and vertical offset.
 - At the beginning of a survey, enter the slope height reading. The horizontal and vertical offsets must also be configured in **MANAGE Antennas**.
 - Refer to "2.1 Overview" for the vertical phase centre variations.
-



If the outside edge of the antenna is above the mechanical reference plane, the vertical offset is negative.

3 Using GPS1200 without RX1200

Use For reference stations in post-processing, real-time and static applications, GPS1200 can be used without RX1200.

Description The receiver is pre-programmed in the office using the RX1200. In the field, the receiver is used without the RX1200 attached. This greatly reduces the knowledge required to operate the instrument in the field. Usually, a tripod or pillar setup is used. Refer to "14 Manage...\Configuration Sets" for full instructions on how to program the receiver.

Use GPS1200 without RX1200

Step	Description
1.	Set up the equipment according to the needs. Refer to "1 Equipment Setup" for details of the equipment setup.
2.	Hold down the ON/OFF button on the receiver for at least 2 s to switch the receiver on.
3.	Check the start time.
4.	Note down information such as <ul style="list-style-type: none"> • start time. • antenna height. • point ID. This information is required for post-processing. Refer to paragraph "Field Record Sheet" for an example for a field record sheet.

Step	Description
5.	The receiver automatically begins to acquire and track satellites and record data as defined in the receiver configuration.
6.	To shut down the equipment press and hold down the ON/OFF button for 4 s. The LED indicators will not be lit when the equipment is switched off. Refer to paragraph "LED Indicators".
7.	Check the stop time.
8.	Note down the stop time.

LED Indicators

Description

Every GPS1200 receiver has three **L**ight **E**mitting **D**iode indicators positioned below the ON/OFF button. They indicate the basic receiver status.

Diagram

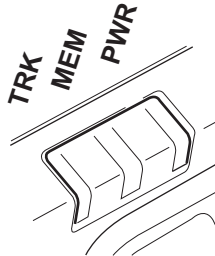

TRK Tracking LED
MEM Memory LED
PWR Power LED

Description of the LED's

IF the LED	is	THEN
TRK	off	no satellites are tracked.
	green	enough satellites are tracked to compute a position.
	flashing green	the first satellite is tracked, a position is not yet available.
MEM	off	no memory device is available. CompactFlash card is not inserted or internal memory not fitted.
	green	memory capacity is okay on selected device.
	flashing green	memory capacity is 75 % full on selected device.
	red	memory is full on selected device.
PWR	off	power is off.
	green	power is okay.
	flashing green	power is low. The remaining time for which enough power is available depends on the type of survey, the real-time device in use, the temperature and the age of the battery.

Field Record Sheet

Some information cannot be entered into the receiver without RX1200 but must be entered into LGO for post-processing. A field record sheet is intended for writing down this necessary information such as point ID and antenna height.

Example

Field Record			
Date:			
Local start time:		Local stop time:	
Receiver serial no.:		Operator name:	
Point ID:		Antenna height:	

4**Using RX1250**

4.1**Overview**

Description

Some important characteristics of the RX1250 are explained in this chapter.

4.2 Switching between Leica SmartWorx software and Windows CE desktop

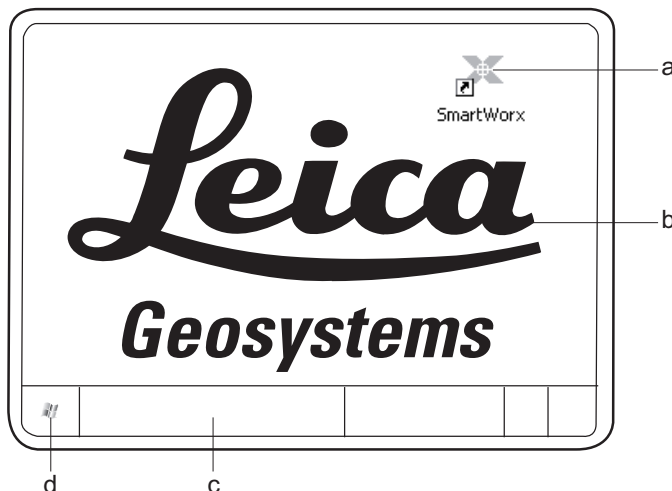

Graphic



RX12_33

- a) Icon to start Leica SmartWorx software
- b) Windows CE desktop
- c) Task bar
- d) Start button

Access Leica SmartWorx software

IF	THEN
RX1250 is started	the Leica SmartWorx software starts up automatically.
Windows CE desktop is active	double click  to display the Leica SmartWorx software. OR  SHIFT PROG (#) to display the Leica SmartWorx software.

IF	THEN
Leica SmartWorx software is minimised	double click  to maximise it. OR select SmartWorx in the task bar to maximise it.

Access Windows CE desktop

IF	THEN
Leica SmartWorx software is to be minimised	SHIFT MINIM (F5) in Main Menu .
Leica SmartWorx software is to be closed	SHIFT EXIT (F6) in Main Menu .
Windows CE task bar is to be displayed	SHIFT PROG ().

4.3

Sleep Mode

Description

In sleep mode, the RX1250 shuts down and reduces power consumption. Rebooting RX1250 from sleep mode is quicker than a cold start after turning off.

Putting RX1250 into sleep mode

The RX1250 can only be put into sleep mode in the Main Menu screen.

Press **SHIFT SLEEP (F3)**.

4.4 Configuring Interfaces

4.4.1 Overview

Description



The required interface configurations for the RX1250 depend on the type of equipment setup.

Equipment setup	Interface configurations	Refer to chapter
Real-Time Reference using SmartAntenna, RX1250 and GHT56	• SmartAntenna interface via Bluetooth or USB	4.4.2
	• Clip-on interface for radio or digital cellular phone in clip-on-housing	4.4.3
SmartRover - External Radio	• SmartAntenna interface via Bluetooth or USB	4.4.2
	• Clip-on interface for radio or digital cellular phone in clip-on-housing	4.4.3

4.4.2

Configuring SmartAntenna Interface

Configuration step-by-step

Step	Description
1.	Select Main Menu: Config...\Interfaces... in the Leica software.
2.	Highlight SmartAntenna .
3.	EDIT (F3)
4.	CONFIGURE SmartAntenna Interface <Use Device: Yes> Select a free Bluetooth port.
5.	DEVCE (F5)
6.	CONFIGURE Devices Highlight ATX1230 GG .
7.	CONT (F1)
8.	SRCH (F4) to search for Bluetooth devices.
	SmartAntenna must be turned on.
9.	CONFIGURE Search Bluetooth Device All available Bluetooth devices are displayed.
10.	Highlight the SmartAntenna to be used.
11.	CONT (F1)
	If the SmartAntenna selected is connected for the first time, a Windows CE authentication request comes up. Type in 0000 as identification number for Leica's Bluetooth and click OK .

Step	Description
	Once the Bluetooth connection is established, the Bluetooth LED on the SmartAntenna starts flashing in blue.

4.4.3

Configuring Clip-On Interface

Configuration step-by-step

Step	Description
1.	Select Main Menu: Config...Interfaces... in the Leica software.
2.	Highlight Real-Time .
3.	EDIT (F3)
4.	CONFIGURE Real-Time Mode <R-Time Mode: Rover> or <R-Time Mode: Reference> <Port: Clip-on>
5.	DEVCE (F5) to select the device attached to the GHT56.
6.	CONT (F1) returns to CONFIGURE Interfaces .

5

Receiver Protection with PIN**Description**

The receiver can be protected by a Personal Identification Number. If the PIN protection is activated, the receiver prompts for PIN code entry after starting up and before **GPS1200 Main Menu** comes up.

If a wrong PIN has been typed in five times, a **Personal UnbloCking** code is required. Refer to "21.6 Start Up & Power Down" for information on activating PIN protection.

This chapter explains the workflow of entering PIN and PUK.

Access

GPS1200 Enter Security PIN Code is automatically accessed during starting up the receiver when **<Use PIN: Yes>** in **CONFIGURE Start Up & Power Down, PIN Code** page and a PIN has been defined before. Refer to "21.6 Start Up & Power Down".

GPS1200 Enter Security PUK Code is automatically accessed during starting up the receiver when a wrong PIN code has been typed in five times.

GPS1200

Enter Security PIN Code



PIN Code : [REDACTED]

OK (F4)

To accept the PIN code and to continue with the subsequent screen.



SHIFT QUIT (F6)

To turn off the receiver.

Description of fields

Field	Option	Description
PIN Code	User input	The PIN code as previously defined in CONFIGURE Start Up & Power Down, PIN Code page. The correct PIN code must be typed in within five attempts or the PUK code is required.

Next step

IF the PIN code entered is	THEN
correct	GPS1200 Main Menu is displayed. Refer to "7 Main Menu".

IF the PIN code entered is	THEN
wrong	refer to paragraph "GPS1200 Enter Security PIN Code Error: 479".
wrong the fifth time	the PUK code is required. Refer to paragraph "GPS1200 Enter Security PIN Code Error: 478".

GPS1200
Enter Security PIN
Code
Error: 479

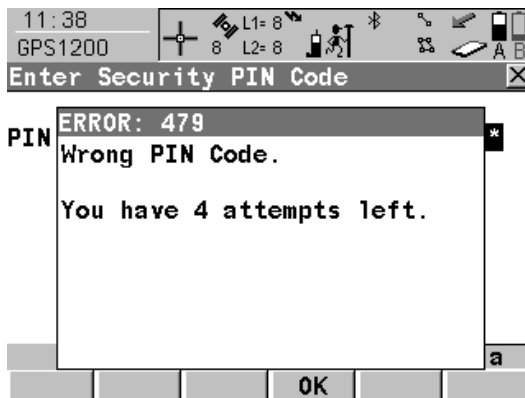

OK (F4)

To return to **GPS1200 Enter Security PIN Code** where a PIN code can be typed in again.

Next step

IF the PIN code entered is	THEN
correct	GPS1200 Main Menu is displayed. Refer to "7 Main Menu".

IF the PIN code entered is	THEN
wrong the fifth time	the PUK code is required. Refer to paragraph "GPS1200 Enter Security PIN Code Error: 478".

**GPS1200
Enter Security PIN Code
Error: 478**

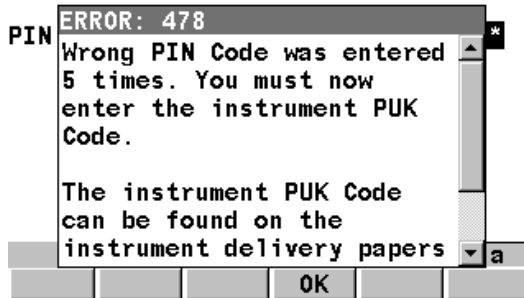

OK (F4)
To continue with the subsequent screen.

Next step
OK (F4) to access **GPS1200 Enter Security PUK Code**.

GPS1200
Enter Security PUK
Code

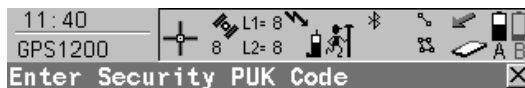

PUK Code : [REDACTED]

Serial No. : 1

OK (F4)

To accept the PUK code and to continue with the subsequent screen.



SHIFT QUIT (F6)

To turn off the receiver.

Description of fields

Field	Option	Description
PUK Code	User input	The PUK code as generated by Leica Geosystems. <ul style="list-style-type: none"> For receivers delivered with firmware version 2.10 or higher, the PUK code comes with the receiver. For receivers delivered with firmware versions lower than v2.10, contact a Leica representative to obtain a PUK code.
Serial No.	Output	The serial number of the receiver. This is needed to obtain the PUK code from Leica Geosystems.

Next step

IF the PUK code entered is	THEN
correct	the old PIN code is cleared and the PIN protection is deactivated. GPS1200 Main Menu is displayed. Refer to "7 Main Menu".
wrong	GPS1200 keeps asking for the correct PUK code. SHIFT QUIT (F6) to turn off the receiver.

6 Configurable Keys

6.1 Hot Keys

Description

Two levels of hot keys exist:

- The first level are the keys **F7, F8, ..., F12**
- The second level is the combination of **SHIFT** and **F7, F8, ..., F12**

Functionality

Hot keys provide a shortcut for quickly and directly carrying out functions or starting application programs assigned to the keys. The assignment of functions and application programs to hot keys is user configurable. Refer to "21.2 Hot Keys & User Menu" for the configuration of hot keys.

Use

- The first level is accessed by pressing **F7, F8, ..., F12** directly.
- The second level is accessed by pressing **SHIFT** first followed by **F7, F8, ..., F12**

Hot keys can be pressed at any time. It is possible that a function or application program assigned to a hot key cannot be executed in certain situations.

Define hot key step-by-step

This step-by-step description shows how to assign the **CONFIGURE Coding & Linework** screen to the **F7** key and to the first line of **GPS1200 User Menu: Job Name**.

Step	Description
1.	Select Main Menu: Config...\General Settings...\Hot Keys & User Menu .
2.	CONFIGURE Hot Keys & User Menu

Step	Description
	For Hot Keys/Shift Hot Keys select < F7: CONF Coding & Linework Settings >. For User Menu select < 1: CONF Coding & Linework Settings >.
3.	CONT (F1)
4.	CONT (F1).
5.	Press F7 to access CONFIGURE Coding & Linework. OR Press USER and 1 to access CONFIGURE Coding & Linework.

6.2 USER Key

Description

The **USER** key opens the user defined menu.

User defined menu

The user defined menu can be configured to contain the most used functions or application programs. The user defined menu can not be accessed while in a **CONFIGURE XX** screen. Refer to "21.2 Hot Keys & User Menu" for the configuration of the user defined menu.

Functionality of the user defined menu

Selecting an option in the menu carries out the function or starts the application program assigned to the option.

Access

Press **USER** to access **GPS1200 User Menu: Job Name**.

GPS1200

User Menu: Job Name

This is an example of what a user defined menu can look like. The softkeys and their order is fixed. The functions and application programs which are assigned to the individual places in the user defined menu can differ depending on the configuration.

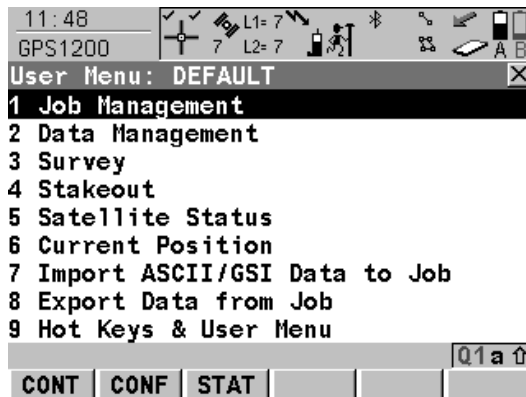

CONT (F1)

To execute the selected function.

CONF (F2)

To access **GPS1200 Configuration: Configuration Set**.

STAT (F3)

To get information on battery status, interface status, etc. Refer to "31 STATUS".

Define USER key step-by-step

To define the **USER** key is the same as for the hot keys. Refer to paragraph "Define hot key step-by-step".

7 Main Menu

7.1 Main Menu Functions

Description

The main menu is normally the first screen displayed when the instrument is switched on. If the PIN protection is active, **GPS1200 Enter Security PIN Code** is displayed first. After typing in the correct PIN code, the main menu is displayed.



If desired, the instrument can be configured to start up with a user defined screen. Refer to "21.6 Start Up & Power Down".

GPS1200 Main Menu



CONT (F1)

To select the highlighted option and to continue with the subsequent screen.

SHIFT OFF (F2)

Available on RX1250. To completely turn RX1250 off.

SHIFT SLEEP (F3)

Available on RX1250. To put RX1250 into sleep mode.

SHIFT MINIM (F5)

Available on RX1250. To minimise Leica software.

SHIFT EXIT (F6)

Available on RX1250. To close Leica software.

Description of the main menu functions

Main menu function	Description	Refer to chapter
Survey	To start measuring.	7.2
Programs...	To select and start application programs.	7.3
Manage...	To manage jobs, data, codelists, configurations sets, antennas and coordinate systems.	7.4
Convert...	<ul style="list-style-type: none">• To export data from a job on the receiver to a file on the CompactFlash card in a customised ASCII format or in DXF format.• To import ASCII, GSI or DXF data from a file on the CompactFlash card to a job on the receiver.• To copy points between jobs.	7.5
Config...	To access all configuration parameters related to a survey, the receiver and the interfaces.	7.6
Tools...	<ul style="list-style-type: none">• To format the memory device.• To upload files relevant for the receiver functionality, for example, firmware and language files.• To transfer non data related files between receiver and CompactFlash card.	7.7

Main menu function	Description	Refer to chapter
	<ul style="list-style-type: none"><li data-bbox="743 204 1331 325">• To perform arithmetic operations such as addition, subtraction, multiplication, division, statistical functions, trigonometric functions, conversions or roots.<li data-bbox="743 342 1331 400">• To view files on the CompactFlash card or the internal memory.<li data-bbox="743 417 1331 445">• To manually type in a licence key.	

7.2

Survey

Access

Select **Main Menu: Survey**.

Description

Survey provides the functionality used to perform the survey.

SURVEY

Survey Begin

11:57 SURVEY

Survey Begin

Job : Job2

Coord System : WGS 1984

Codelist : <None>

Config Set : RTK Rover

Antenna : AX1202 Pole

Q1a ↑

CONT CONF CSYS

CONT (F1)

To accept settings and to continue with screen **SURVEY Survey: Job Name**.

CONF (F2)

Available for configuration sets with **<R-Time Mode: None>** or **<R-Time Mode: Rover>**. To configure auto point and hidden point measurements functionality.

CSYS (F6)

To change the coordinate system. Refer to "13.4.1 Creating a New Coordinate System" for information on defining a coordinate system.

Next step

For **Main Menu: Survey**

Refer to chapter 44.

7.3 Programs...

Access

Select **Main Menu: Programs...**
OR
Press **PROG**.

Description

Programs... accesses the application programs menu. The screen of the application programs menu is called **GPS1200 Programs**.

GPS1200 Programs

The application programs menu contains all loaded application programs including Survey. They are listed in the order in which they were loaded.

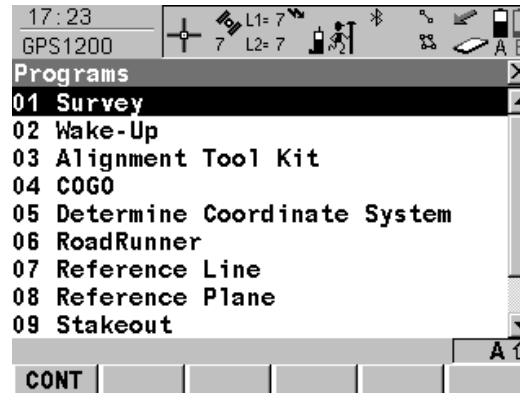

CONT (F1)

To select the highlighted option and to continue with the subsequent screen.

Next step

For **Main Menu: Programs...\Survey**
For **Main Menu: Programs...\Stakeout**
For **Main Menu: Programs...\COGO**

Refer to chapter 44.
Refer to chapter 43.
Refer to chapter 37.

For Main Menu: Programs...\Reference Line	Refer to chapter 41.
For Main Menu: Programs...\Reference Plane	Refer to chapter 42.
For Main Menu: Programs...\Determine Coordinate System	Refer to chapter 38.
For Main Menu: Programs...\Volume Calculations	Refer to chapter 49.
For Main Menu: Programs...\Wake-Up	Refer to chapter 49.
For Main Menu: Programs...\RoadRunner	Refer to GPS1200 Road-Runner Manual.

7.4 Manage...

Access

Select **Main Menu: Manage...**

Description

Manage... is used to manage

- jobs.
- data.
- codelists.
- coordinate systems.
- configuration sets.
- antennas.

Management functions include creating, selecting, editing and deleting.

GPS1200 Management

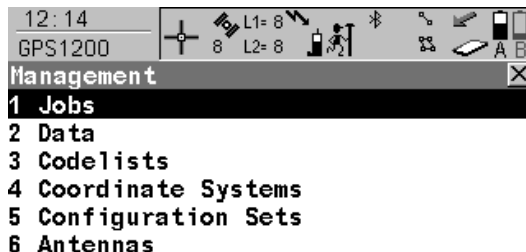

CONT (F1)

To select the highlighted option and to continue with the subsequent screen.

Next step

For **Main Menu: Manage...\Jobs**
 For **Main Menu: Manage...\Data**
 For **Main Menu: Manage...\Codelists**

Refer to chapter 8.
 Refer to chapter 9.
 Refer to chapter 10.

For **Main Menu: Manage...**\Coordinate Systems
For **Main Menu: Manage...**\Configuration Sets
For **Main Menu: Manage...**\Antennas

Refer to chapter 13.
Refer to chapter 14.
Refer to chapter 15.

7.5 Convert...

Access

Select **Main Menu: Convert...**

Description

Convert... provides access to data exchange options.

GPS1200

Convert Data



CONT (F1)



To select the highlighted option and to continue with the subsequent screen.

Next step

For **Main Menu: Convert...\Export Data from Job**
 For **Main Menu: Convert...\Import Data to Job**
 For **Main Menu: Convert...\Copy Points Between Jobs**

Refer to chapter 16.
 Refer to chapter 17.
 Refer to chapter 18.

7.6

Config...

Access

Select **Main Menu: Config...**

OR

Press **USER** and then **CONF (F2)**.

Description

Config... accesses all configuration parameters related to a survey, the receiver and the interfaces. Any changes made are stored in the configuration set.

GPS1200

Configuration: Configuration Set



CONT (F1)

To select the highlighted option and to continue with the subsequent screen.

Next step

For **Main Menu: Config...\Survey Settings...**

Refer to chapter 19.

For **Main Menu: Config...\Instrument Settings...**

Refer to chapter 20.

For **Main Menu: Config...\General Settings...**

Refer to chapter 21.

For **Main Menu: Config...\Interfaces...**

Refer to chapter 22.

7.7

Tools...

Access

Select **Main Menu: Tools...**

Description

Tools... provides functionality which is not directly related to surveying data.

GPS1200

Tools Menu



CONT (F1)



To select the highlighted option and to continue with the subsequent screen.

Next step

For **Main Menu: Tools...\Format Memory Device**

Refer to chapter 25.

For **Main Menu: Tools...\Transfer Objects...**

Refer to chapter 26.

For **Main Menu: Tools...\Upload System Files...**

Refer to chapter 27.

For **Main Menu: Tools...\Calculator**

Refer to chapter 28.

For **Main Menu: Tools...\File Viewer**

Refer to chapter 29.

For **Main Menu: Tools...\Licence Keys**

Refer to chapter 30.

8**Manage...\Jobs**

8.1**Overview**

Description

Jobs

- structure surveying projects.
 - contain all points, lines, areas and codes that are recorded and stored.
 - can be downloaded to LGO for post-processing or for data transfer to a further program.
 - can be uploaded from LGO, for example, for real-time stake out operations.
 - may be stored on the CompactFlash card or internal memory, if fitted.
-

Type of jobs

- Data jobs. Explained in this chapter.
 - DTM jobs. Refer to "43.4.4 Staking Out a DTM".
 - Road jobs. Refer to the GPS1200 RoadRunner Manual.
-

Default job

A job called **Default** is available on the receiver after formatting the memory device, inserting a previously formatted CompactFlash card or deleting all jobs from **MANAGE Jobs (Device)**.

Active job

The active job is the one data is stored to. One job is always considered the active job. After formatting the memory device, the job **Default** is used until a user defined job is created and selected.

8.2

Accessing Job Management

Access

Select **Main Menu: Manage...Jobs.**

OR

Press a hot key configured to access the screen **MANAGE Jobs (Device)**. Refer to "6.1 Hot Keys" for information on hot keys.

OR

Press **USER**. Refer to "6.2 USER Key" for information on the **USER** key.

OR

From a choicelist in some screens for example the **XX Begin** screen of application programs.

MANAGE Jobs (Device)

Listed are all data jobs stored on the CompactFlash card or in the internal memory, if fitted, depending on the current device.

Name	Date
Default	19.10.05
Job1	17.02.05
Job2	17.02.05

CONT (F1)

To select the highlighted job and to return to the screen from where this screen was accessed.

NEW (F2)

To create a job. Refer to "8.3 Creating a New Job".

EDIT (F3)

To edit the highlighted job. Refer to "8.4 Editing a Job".

DEL (F4)

To delete the highlighted job.

CFCRD (F6) or INTL (F6)

Available for receivers with internal memory.
To change between viewing jobs stored on the CompactFlash card or internal memory.

Next step

IF a job	THEN
is to be selected	highlight the desired job. CONT (F1) closes the screen and returns to the screen from where MANAGE Jobs (Device) was accessed.
is to be created	NEW (F2) . Refer to "8.3 Creating a New Job".
is to be edited	highlight the job and EDIT (F3) . Refer to "8.4 Editing a Job".

8.3

Creating a New Job

Access

Refer to "8.2 Accessing Job Management" to access **MANAGE Jobs (Device)**.

Create job step-by-step

The following table explains the most common settings. Refer to the stated chapter for more information on screens.

Step	Description	Refer to chapter
1.	In MANAGE Jobs (Device) highlight a job. The settings of this job are applied to the new job.	8.2
2.	NEW (F2) to access MANAGE New Job .	

12:21
MANAGE
New Job
General | Code list | Coord System | Avge
Name : Job1
Description :
: - - - -
: - - - -
Creator : Ch
Device : CF Card
Q1 a ↑
STORE PAGE

STORE (F1)

To store the settings and to return to the screen from where **MANAGE New Job** was accessed.

PAGE (F6)

To change to another page on this screen.

Step	Description	Refer to chapter
3.	<p>MANAGE New Job, General page</p> <p><Name:> A unique name for the new job. The name may be up to 16 characters long and may include spaces. Input required.</p> <p><Description:> Two lines for a detailed description of the job. This can be for example, work to be performed or the classes contained in the job. Input optional.</p> <p><Creator:> The person's name who is creating the new job. Input optional.</p> <p><Device:> The device on which the new job will be stored. Depending on the receiver options, this may be an output field.</p>	
4.	PAGE (F6) changes to the Codelist page.	
5.	<p>MANAGE New Job, Codelist page</p> <p><Codelist:> Choosing a codelist copies the codes to the job.</p>	11
6.	PAGE (F6) changes to the Coord System page.	
7.	<p>MANAGE New Job, Coord System page</p> <p><Coord System:> Choosing a coordinate system attaches it to the job. If it is not known which coordinate system to use, select <Coord System: WGS 1984 >.</p> <p>All other fields on this screen are output fields. They depend on the transformation type of the selected coordinate system.</p>	13.4
8.	PAGE (F6) changes to the Avge page.	

Step	Description	Refer to chapter
9.	<p>MANAGE New Job, Avge page</p> <p>In order to check measurements, the same point can be measured more than once. If activated, an average or an absolute difference is calculated.</p> <p><Averaging Mode:> Defines the averaging principles for multiple measured points. <Averaging Mode: Average> computes the average for the position and the height. Points exceeding the defined limits are marked with ! in MANAGE Edit Point, Mean page. <Averaging Mode: Absolute Diffs> computes the absolute differences between two points selected from a list of measured points which are all stored with the same point ID. The selection determines the availability of the subsequent fields for setting the acceptable averaging limits or absolute differences.</p> <ul style="list-style-type: none"> For <Averaging Mode: Average>: <ul style="list-style-type: none"> <Method:> The method used for computing the average. <Method: Weighted> calculates a weighted average while <Method: No Weighting> is calculating an arithmetic average. <Points to Use:> The type of points which will be taken into account for averaging. <Avge Limit Pos:> and <Avge Limit Ht:> The acceptable difference for the position and height components. 	9.3.4

Step	Description	Refer to chapter
	<ul style="list-style-type: none">• For <Averaging Mode: Absolute Diffs>: <Points to Use> The type of points which will be taken into account for absolute differences. From <Easting> to <Cartesian Z> The acceptable absolute differences for each coordinate component.• For <Averaging Mode: Off>: No other fields are available.	
10.	STORE (F1) creates the new job and returns to MANAGE Jobs (Device) .	

8.4



Editing a Job



Access



Refer to "8.2 Accessing Job Management" to access **MANAGE Jobs (Device)**.

Edit job step-by-step

The following table explains the most common settings. Refer to the stated chapter for more information on screens.

Step	Description	Refer to chapter
1.	In MANAGE Jobs (Device) highlight a job to be edited.	
2.	EDIT (F3)	
3.	MANAGE Edit Job: Job Name, General page <Name:> Rename the job. <Device:> Cannot be edited. The remaining functionality on this page is identical with the creation of a new job.	8.3
	DATA (F5) accesses MANAGE Data: Job Name . To view, edit and delete points, lines and areas stored with the job. Points, lines and areas are shown on separate pages. Selected sort and filter settings apply.	9.2
	SHIFT LOG (F5) accesses MANAGE Data Log: Job Name . To view, edit and delete points, lines and areas stored with the job. Points, lines and areas are sorted by time in one list.	9.5
4.	PAGE (F6) changes to the Codelist page.	
5.	Are codes stored in the job?	

Step	Description	Refer to chapter
	<ul style="list-style-type: none"> • If no, continue with step 6. • If yes, continue with step 8. 	
6.	<p>No codes are stored in the job.</p> <p>MANAGE Edit Job: Job Name, Codelist page</p> <p><Codelist: <None>> This default setting can be changed. Choosing a codelist copies the codes to the job. All codelists from Main Menu: Manage...\Codelists can be selected.</p>	11
7.	<p>PAGE (F6) changes to the Coord System page. Continue with step 10.</p>	
8.	<p>Codes are stored in the job.</p> <p>MANAGE Edit Job: Job Name, Codelist page</p> <p><Codelist:> If codes had been copied from a System RAM codelist, the name of the codelist is displayed. If codes have been typed in, then the name of the active job is displayed.</p>	
	<p>IMPRT (F2) adds additional codes from a new codelist to the job. The name of this codelist is copied to the job.</p>	10
	<p>SHIFT EXPRT (F2) copies codes from the job to an existing or new codelist.</p>	10
	<p>CODES (F4) views codes currently stored in the job.</p>	8.5
9.	<p>PAGE (F6) changes to the Coord System page.</p>	
10.	<p>MANAGE Edit Job: Job Name, Coord System page</p>	

Step	Description	Refer to chapter
	The functionality on this page is identical with the creation of a new job.	8.3
11.	PAGE (F6) changes to the Avge page.	
12.	MANAGE Edit Job: Job Name, Avge page The functionality on this page is identical with the creation of a new job.	8.3
	DATA (F5) accesses MANAGE Data: Job Name . To view, edit and delete points, lines and areas stored with the job. Points, lines and areas are shown on separate pages. Selected sort and filter settings apply.	9.2
	SHIFT LOG (F5) accesses MANAGE Data Log: Job Name . To view, edit and delete points, lines and areas stored with the job. Points, lines and areas are sorted by time in one list.	9.5
13.	STORE (F1) stores the changes and returns to the screen from where MANAGE Edit Job: Job Name was accessed.	

8.5 Managing Job Codes

Description

To view, edit, group and sort all codes currently stored in the job. The functionality of this screen is mainly the same as for **MANAGE Codes**. For simplicity, the functionality which is different from **MANAGE Codes** is explained here. Refer to "10.5 Managing Codes" for information on **MANAGE Codes**.

Access step-by-step

Available for jobs which have a codelist attached.

Step	Description
1.	Refer to "8.2 Accessing Job Management" to access MANAGE Jobs (Device) .
2.	In MANAGE Jobs (Device) highlight a job to be edited.
3.	EDIT (F3) to access MANAGE Edit Job: Job Name .
4.	In MANAGE Edit Job: Job Name , PAGE (F6) until the Codelist page is active.
5.	CODES (F4) to access MANAGE Job Codes .

MANAGE Job Codes

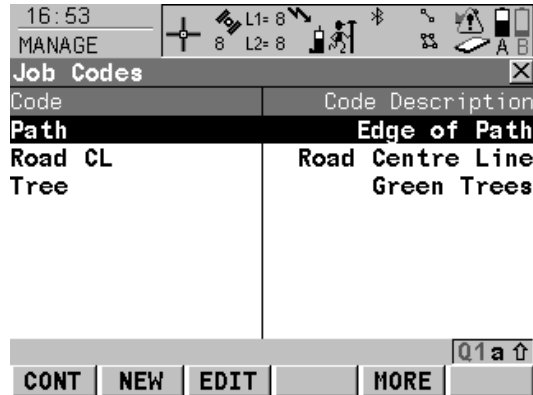

CONT (F1)

To return to **MANAGE Edit Job: Job Name, Codelist** page.

NEW (F2)

To create a new code. Refer to "10.5.2 Creating a New Code".

EDIT (F3)

To edit the highlighted code. Accesses **MANAGE Edit Code** where new attributes can be added to a code and line styles can be changed. Refer to paragraph "MANAGE Edit Code".

MORE (F5)

To display information about the code group, the code type, the code description and the quick codes if available.

SHIFT GROUP (F4)

To access **MANAGE Code Groups**. To view, create, activate and deactivate code groups. Refer to "10.6 Managing Code Groups".

SHIFT SORT (F5)

To access **MANAGE Sort Codes**. To sort codes by code name, code description, quick code or last used.

Next step

IF	THEN
the job codes do not need to be changed	CONT (F1) closes the screen and returns to the screen from where MANAGE Job Codes was accessed.
a new job code is to be created	NEW (F2) . Refer to "10.5.2 Creating a New Code".
an existing job code is to be edited	highlight the job code and EDIT (F3) . Refer to paragraph "MANAGE Edit Code".

**MANAGE
Edit Code**

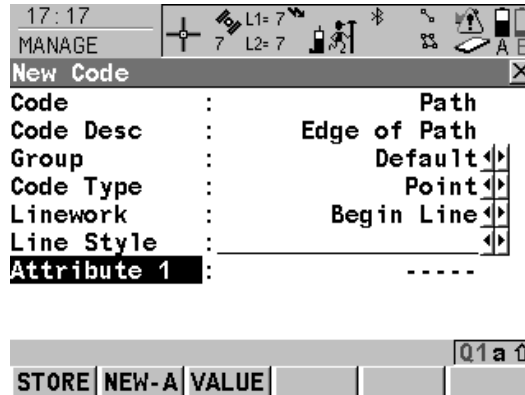

STORE (F1)

To store the code including any newly created attributes and to return to the screen from where **MANAGE Edit Code** was accessed.

NEW-A (F2)

To add a new attribute to a code.

NAME (F3) or VALUE (F3)

Available for attributes for which an attribute name can be typed in. To highlight **<Attribute n:>** or the field for the attribute value. The name of **<Attribute n:>** can be edited and an attribute value can be typed in.

The behaviour of this screen varies with the type of code to be edited. The differences are explained in the table.

Type of code	Description
Point codes and Free codes	New attributes can be added with NEW-A (F2) .
Line codes and Area codes	<ul style="list-style-type: none">• New attributes can be added with NEW-A (F2).• The line style can be changed. This new line style is stored to the code. It can be decided whether or not to update the line style of all previously stored lines/areas with this code in this job.

9**Manage...\Data**

9.1**Overview**

Description

Data is a generic term for points, lines and areas.

Data management is the administration of data stored in the active job. This includes

- viewing data with their related information.
 - editing data.
 - creating new data.
 - deleting existing data.
 - filtering existing data.
-

Objects

Objects

- are points, lines and areas.
 - have a unique identification ID. This is the point ID, the line ID and the area ID.
 - may or may not have a code attached. This is either a point code, a line code or an area code depending on the type of object. Refer to "11 Coding" for information on coding.
-

9.2

Accessing Data Management

Access

Select **Main Menu: Manage...\Data**.

OR

Press a hot key configured to access the screen **MANAGE Data: Job Name**. Refer to "6.1 Hot Keys" for information on hot keys.

OR

Press **USER**. Refer to "6.2 USER Key" for information on the **USER** key.

OR

From a choicelist in some screens for example in application programs.

OR

Tap the line/area icon. Refer to the GPS1200 System Field Manual for information on icons.



The objects listed on the pages belong to the currently active job. The objects listed and their order depend on the active sort and filter settings. An active filter for a page is indicated by ¶ to the right of the name of the page. Refer to "9.6 Point Sorting and Filters" for information about sort and filter settings.

MANAGE

Data: Job Name,
Points page

Point	3D CQ	Class
101	0.000	CTRL
200	0.000	CTRL
300	0.000	CTRL
400	0.000	CTRL
ant4	0.000	REF

Bottom menu: **CONT** **NEW** **EDIT** **DEL** **MORE** **PAGE**

CONT (F1)

To close the screen and return to the screen from where this screen was accessed.

NEW (F2)

To create a point.

EDIT (F3)

To edit the highlighted point.

DEL (F4)

To delete the highlighted point.

MORE (F5)

To display information about the codes if stored with any point, the time and the date of when the point was stored, the 3D coordinate quality, the class and the flag for Linework.

PAGE (F6)

To change to another page on this screen.

SHIFT LOG (F4)

To view points, lines, areas and free codes stored with the job sorted by time. Refer to "9.5 Data Log".

SHIFT FILT (F5)

To define sort and filter settings. Refer to "9.6 Point Sorting and Filters".

Next step

IF	THEN
a point is to be created	highlight the point and NEW (F2) . Refer to "9.3.2 Creating a New Point".

IF	THEN
a point is to be edited	highlight the point and EDIT (F2) . Refer to "9.3.3 Editing a Point".
a line/area is to be managed	PAGE (F6) changes to the Lines (X) and Areas (X) page. Refer to paragraph "MANAGE Data: Job Name, Lines (X) page; MANAGE Data: Job Name, Areas (X) page".

MANAGE

Data: Job Name,
Lines (X) page;

MANAGE

Data: Job Name,
Areas (X) page

The explanations for the softkeys given below are valid for both pages.

The number in brackets next to the name of the page indicate the number of open lines/areas. Example: **Lines (2)/Areas (2)** means that two lines/areas are open.

Line	Start Time	Open
100	11:50:26	Yes
101	11:50:19	No

Q1 a ↑

CONT NEW EDIT CLOSE MORE PAGE

CONT (F1)

To close the screen and return to the screen from where this screen was accessed.

NEW (F2)

To create a line/area. After storing the new line/area, all existing lines and areas which are open are closed.

EDIT (F3)

To edit the highlighted line/area.

CLOSE (F4) and OPEN (F4)

To change between the options in the **Open** column of the highlighted line/area.

MORE (F5)

To display information about the codes if stored with any line/area, the start time, the end time of when the last point was added to the line/area, the length of the line, the perimeter and the area of the area.

PAGE (F6)

To change to another page on this screen.

SHIFT DEL (F4)

To delete the highlighted line/area.

SHIFT FILT (F5)

To define sort and filter settings. Refer to "9.6 Point Sorting and Filters".

Description of columns

Column	Description
Line or Area	The listed lines/areas already stored in the active job.
Open	<p>The status of a line/area.</p> <ul style="list-style-type: none"> • Yes The line/area is open. Measured points are assigned to the line/area. • No The line/area is closed. Measured points are not assigned to the line/area. <p>CLOSE (F4) and OPEN (F4) change between the options.</p>

Next step

IF the line/area	THEN
management is completed	CONT (F1) closes the screen and returns to the screen from where this screen was accessed.
is to be opened	highlight the line/area and OPEN (F4) .
which was last used is to be opened	press a hot key configured to re-open last used line/area. This hot key can be used at any time. Refer to "6.1 Hot Keys" for information on hot keys.
is to be closed	highlight the line/area and CLOSE (F4) OR press a hot key configured to close all open lines/areas. This hot key can be used at any time. Refer to "6.1 Hot Keys" for information on hot keys.
is to be created	NEW (F2) . Refer to "9.4.2 Creating a New Line/Area".
is to be edited	highlight the line/area and EDIT (F3) to access MANAGE Edit Line: Line ID or MANAGE Edit Area: Area ID . Refer to "9.4.3 Editing a Line/Area".
is to be viewed	PAGE (F6) until the Map page is active. Refer to "32.5 Map Mode" for information about the functionality and softkeys available on the Map page.

9.3 Point Management

9.3.1 Terminology

Description

This chapter describes technical terms related to data management.

Coordinate triplet

A measured point consists of three coordinate components - two horizontal components and one vertical component. The generic term for the three coordinate components is coordinate triplet.

Depending on the class, a point ID can contain more than one coordinate triplet of the same and/or of different classes.

Class

The class describes the type of coordinate triplet.

Description of classes

The following table shows the classes in descending hierarchical order.

Class	Characteristic	Description
CTRL	Type	Control points. Automatically assigned to entered points or manually assigned to calculated points from COGO.
	Instrument source	GPS, TPS or LGO
	Number of triplets	One
ADJ	Type	Adjusted points using the adjustment program.
	Instrument source	LGO
	Number of triplets	One

Class	Characteristic	Description
REF	Type	<ul style="list-style-type: none"> Reference point received by a real-time rover Station point set by Setup application program.
	Instrument source	GPS, TPS or LGO
	Number of triplets	One
AVGE	Type	Averaged point calculated when more than one coordinate triplet of class MEAS exist for the same point ID unless <Averaging Mode: Off> .
	Instrument source	GPS or TPS
	Number of triplets	One
MEAS	Type	<ul style="list-style-type: none"> Measured points differentially corrected using real-time phase, real-time code or post-processing. Measured points with angles and distances. Calculated from some application programs.
	Instrument source	GPS, TPS or LGO
	Number of triplets	Multiple. With more than one measured coordinate triplet, the average for the position and the height can be computed.
NAV	Type	Navigated points using uncorrected code solutions of a single epoch or SPP positions.
	Instrument source	GPS
	Number of triplets	Multiple

Class	Characteristic	Description
EST	Type Instrument source Possible number of triplets	Estimated points from LGO. LGO . One
NONE	Type Instrument source Possible number of triplets	Measured points with angles. TPS Unlimited

Sub class

The sub class describes certain classes in detail. It indicates the status of the position when a coordinate triplet was measured and how the coordinates were determined.

Sub class	Description	Instrument source
COGO	Indirect coordinate determination with application program COGO.	GPS or TPS
NONE	Direction is available but no coordinates. Height is available but no position coordinates.	TPS Level
TPS	Measured with distances and angles.	TPS
Fixed (Height)	Manually entered and fixed in height.	GPS or TPS
Fixed (Position)	Manually entered and fixed in position.	GPS or TPS
Fixed (Pos & Ht)	Manually entered and fixed in position and height.	GPS or TPS

Sub class	Description	Instrument source
GPS Code Only	Direct coordinate determination with code solution.	GPS
GPS Fixed	Direct coordinate determination with phase fixed solution.	GPS
GPS Float	Direct coordinate determination with autonomous solution coming from LGO.	GPS
Hidden Point	Indirect coordinate determination with hidden point measurements.	GPS or TPS
Additional sub classes for GLONASS sensors:		
GNSS Code Only	Direct coordinate determination with code solution.	GPS
GNSS Fixed	Direct coordinate determination with phase fixed solution.	GPS
GNSS Float	Direct coordinate determination with autonomous solution coming from LGO.	GPS

Source

The source describes the application program or functionality that generated a coordinate triplet and the method with which it was created.

Source	Originated from application program/functionality	Instrument source
ASCII File	Convert Data, Import ASCII/GSI Data to Job	GPS or TPS
Arc Base Pt	COGO, Arc Calculation - Base Point	GPS or TPS

Source	Originated from application program/functionality	Instrument source
Arc Centre Pt	COGO, Arc Calculation - Centre Point	GPS or TPS
Arc Offset Pt	COGO, Arc Calculation - Offset Point	GPS or TPS
Arc Segmt Pt	COGO, Arc Calculation - Segmentation	GPS or TPS
Backward Brg-Dist	Hidden point measurements, Backward Bearing and Distance	GPS
Bearing-Distance	Hidden point measurements, Bearing and Distance	GPS
Chainage-Offset	Hidden point measurements, Chainage and Offset	GPS
COGO Area Divsn.	COGO Area Division	GPS or TPS
COGO Shift/Rtn	COGO, Shift, Rotate & Scale (Manual) COGO, Shift, Rotate & Scale (Match Pts)	GPS or TPS
COGO Traverse	COGO, Traverse	GPS or TPS
Copied Point	Convert Data, Copy points between jobs	GPS or TPS
Cross Section	Survey Cross Section	GPS or TPS
Double Bearing	Hidden point measurements, Double Bearing	GPS
Double Distance	Hidden point measurements, Double Distance	GPS
GSI File	Convert Data, Import ASCII/GSI Data to Job	GPS or TPS
Hidden Point	Hidden Point, auxiliary points	TPS
Intsct (Brg Brg)	COGO, Intersection - Bearing - Bearing	GPS or TPS
Intsct (Brg Dst)	COGO, Intersection - Bearing - Distance	GPS or TPS

Source	Originated from application program/functionality	Instrument source
Intsct (Dst Dst)	COGO, Intersection - Distance - Distance	GPS or TPS
Intsct (4 Pts)	COGO, Intersection - By points	GPS or TPS
LandXML	Design to Field in LGO converting data from LandXML software to be used in the field	LGO
Line Base Pt	COGO, Line Calculation - Base Point	GPS or TPS
Line Offset Pt	COGO, Line Calculation - Offset Point	GPS or TPS
Line Segmt Pt	COGO, Line Calculation - Segmentation	GPS or TPS
None	No information on the source is available	GPS or TPS
RefLine (Grid)	Reference Line, staked out in a defined grid	GPS or TPS
RefLine (Meas)	Reference Line, measured	GPS or TPS
RefLine (Stake)	Reference Line, staked out	GPS or TPS
Ref Plane (Meas)	Reference Plane, measured	GPS or TPS
Ref Plane (Scan)	Reference Plane, scan	TPS
Road Runner	Road Runner	GPS or TPS
Sets of Angles	Sets of Angles	TPS
Setup (Known BS)	Setup, Known Backsight Point	TPS
Setup (Loc Rsct)	Setup, Local Resection	TPS
Setup (Ori&Ht)	Setup, Orientation and Height Transfer	TPS
Setup (Resect)	Setup, Resection	TPS

Source	Originated from application program/functionality	Instrument source
Setup (Resect H)	Setup, Resection Helmert	TPS
Setup (Set Az)	Setup, Set Azimuth	TPS
Srvy Auto Offset	Survey Auto Points, automatically recorded with offsets	GPS or TPS
Stakeout	Stakeout	GPS or TPS
Survey	Survey, measured	TPS
Survey (Auto)	Survey Auto Points, automatically recorded	TPS
Survey (Event)	Survey, Event input	GPS
Survey (Instant)	Survey, measured with <Pt Occupation: Instantaneous> in CONFIGURE Point Occupation Settings	GPS
Survey (Rem Pt)	Survey, Remote Point	TPS
Survey (Static)	Survey, measured with <Pt Occupation: Normal> in CONFIGURE Point Occupation Settings	GPS
Traverse	Traverse	TPS
Unknown	-	GPS or TPS
User Application	Customised application programs	GPS or TPS
User Entered	Manually entered point	GPS or TPS

Instrument source

The instrument source describes where the coordinate triplet was measured or entered. The options are **GPS**, **TPS**, **LGO** or **Level**.

Coordinate quality

Description

The **Coordinate Quality** is

- computed on the rover for code solutions and phase fixed solutions.
- an indicator for the quality of the observations.
- an indicator for the current satellite constellation.
- an indicator for different environmental conditions.
- derived such that there is at least a two third probability that the computed position deviates from the true position by less than the CQ value.
- different from the standard deviation.

CQ versus standard deviation

The standard deviation as CQ would often be too optimistic. This is why the computation of the CQ in GPS1200 is not simply based on the basic standard deviation algorithms.

For the standard deviation, there is, statistically, a 39.3 % probability in 2D that the computed position deviates from the true position by less than the standard deviation. This is not enough for a reliable quality indicator.

This is particularly true for low redundancy situations such as a constellation of four satellites. In such a case the RMS converges to zero and the standard deviation would show an unrealistically small value.

Computation

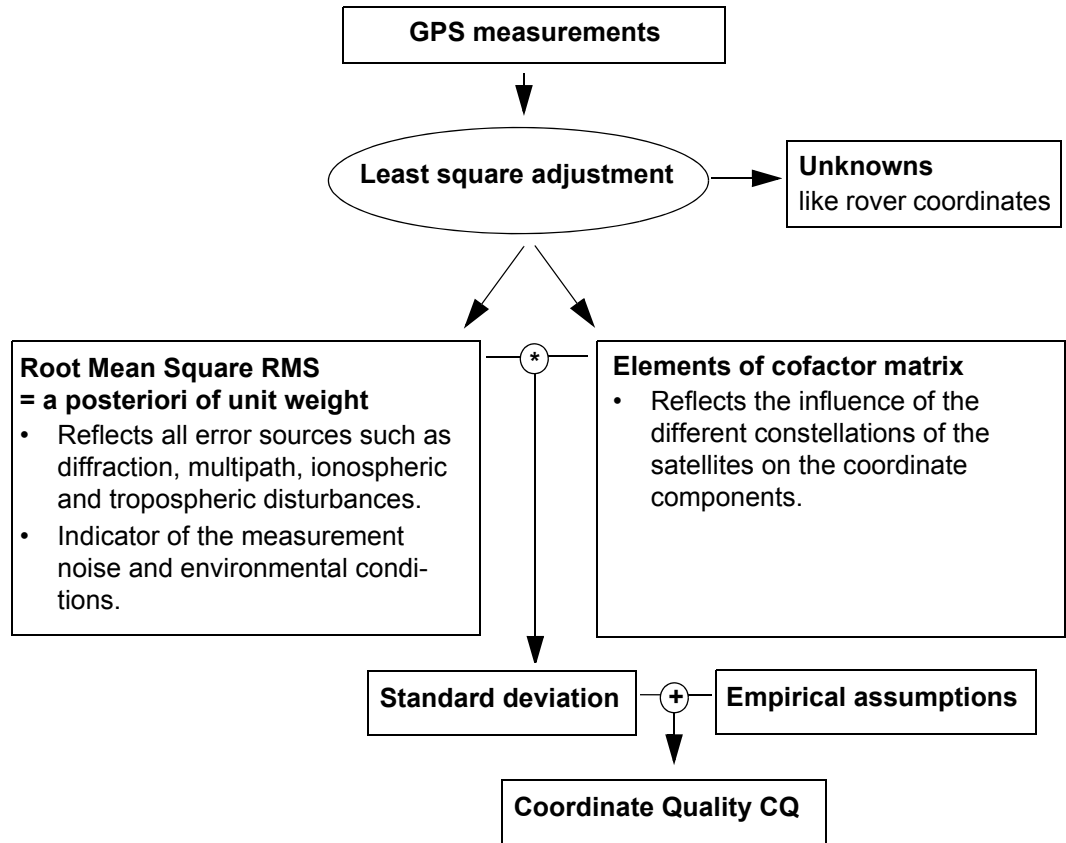

Range

For a phase fixed solution: Centimetre level

For a code solution: From 0.4 to 5 m.

Position CQ versus height CQ

All GPS computed positions are almost twice as accurate in plan than in height. For the position determination, satellites can appear in all four quadrants. For the height determination, satellites can appear in two quadrants. This weakens the height position compared to the plan position.

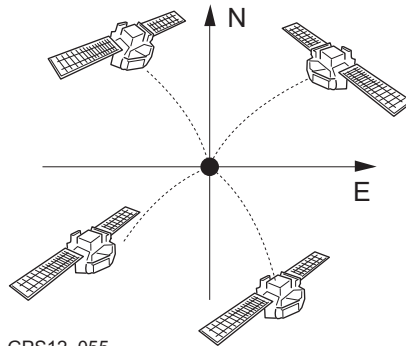

Position determination with satellites appearing in all four quadrants.

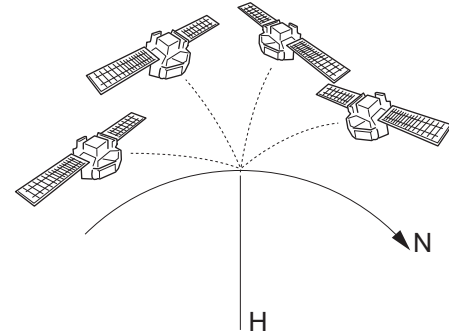

Height determination with satellites appearing in two quadrants.

9.3.2



Creating a New Point



Access





Refer to "9.2 Accessing Data Management" to access **MANAGE Data: Job Name**.

Create point step-by-step

The following table explains the most common settings. Refer to the stated chapter for more information on screens.

Step	Description	Refer to chapter
1.	MANAGE Data: Job Name, Points page	
2.	NEW (F2) to access MANAGE New Point .	
3.	<p>MANAGE New Point, Coords page</p> <p><Point ID:> The name of the new point. The configured point ID template is used. The ID can be changed in the following ways:</p> <ul style="list-style-type: none"> • To start a new sequence of point ID's type over the point ID. • For an individual name independent of the ID template SHIFT INDIV (F5). SHIFT RUN (F5) changes back to the next ID from the configured ID template. <p>Enter a point ID and the coordinates.</p>	
	COORD (F2) views other coordinate properties.	
	Negative geodetic coordinates are interpreted as being of the opposite hemisphere or other side of the central meridian. For example, entering -25 °N will be stored as 25 °S, entering -33 °E will be stored as 33 °W.	

Step	Description	Refer to chapter
	NORTH (F3) or SOUTH (F3) . Available for local geodetic or WGS 1984 geodetic coordinates when <Local Lat:> or <WGS 1984 Lat:> is highlighted. Changes between North and South latitude.	
	EAST (F3) or WEST (F3) . Available for local geodetic or WGS 1984 geodetic coordinates when <Local Long:> or <WGS 1984 Long:> is highlighted. Changes between East and West longitude.	
	SHIFT ELL H (F2) or SHIFT ORTH (F2) . Available for local coordinates. Changes between the ellipsoidal and the orthometric height.	
4.	PAGE (F6) changes to the Code page.	
5.	<p>MANAGE New Point, Code page</p> <p>The setting for <Thematc Codes:> in CONFIGURE Coding & Line-work determines the availability of the subsequent fields and softkeys.</p> <ul style="list-style-type: none"> For <Thematc Codes: With Codelist>: The codes from the job codelist are used. <Point Code:> All point codes of the job codelist can be selected. The description of the code is shown as an output field. The attributes are shown as output, input or choicelist fields depending on their definition. 	19.3

Step	Description	Refer to chapter
	<ul style="list-style-type: none"> For <Thematic Codes: Without Codelist>: Codes for points can be typed in but not selected from a codelist. <Code:> The code to be stored with the point. A check is performed to see if a point code of this name already exists in the job. If so, the according attributes are shown. <Attribute n:> Up to eight attribute values are available. 	
6.	Is <Thematic Codes: With Codelist> ? <ul style="list-style-type: none"> If yes, continue with the next row. If no, continue with step 7. 	
	NEW-A (F2) allows additional attributes to be created for this point code.	
	NAME (F3) or VALUE (F3) Available for attributes for which an attribute name can be typed in. To highlight <Attribute n:> or the field for the attribute value. The name of <Attribute n:> can be edited and an attribute value can be typed in.	
	LAST (F4) recalls the last used attribute values which were stored with this point code.	
	DEFLT (F5) recalls the default attribute values for the selected code.	
7.	STORE (F1) stores the new point entered and all associated information and returns to MANAGE Data: Job Name, Points page. The properties stored with the point are:	

Step	Description	Refer to chapter
	Class: CTRL Sub class: Fixed (Pos & Ht) Source: User Entered Instrument source: GPS	
	It may happen that a point with the same point ID exists in the job. If the codes and/or attribute values of the new and the existing point do not match, a screen opens where they can be corrected.	11.6

9.3.3





Editing a Point



Access



Refer to "9.2 Accessing Data Management" to access **MANAGE Data: Job Name**.

Edit point step-by-step



The following table explains the most common settings. Refer to the stated chapter for more information on screens.

Step	Description	Refer to chapter
1.	In MANAGE Data: Job Name, Points page highlight a point to be edited.	
2.	EDIT (F3) to access MANAGE Edit Point: Point ID .  The visible pages on this screen depend on the properties of the point being edited.	
3.	MANAGE Edit Point: Point ID, Coords page It is possible to edit the point ID and for points of <Class: CTRL> and <Class: EST> also the coordinates. Other point related data is shown in output fields.  Points of <Class: REF> cannot be renamed.  Changing the point ID for a point of any class applies this new point ID to all other points with the same original name, regardless of class.	9.3.1
	MORE (F5) displays information about class, sub class, 3D coordinate quality, time and date of when point was stored, instrument source, source and the flag for Linework if available.	9.3.1
	COORD (F2) views other coordinate types.	

Step	Description	Refer to chapter
	<p>SHIFT ELL H (F2) or SHIFT ORTH (F2). Available for local coordinates. Change between the option to enter an ellipsoidal or an orthometric height.</p> <p>Changing the height type does not edit the point.</p>	
4.	<p>Is <Class: MEAS>?</p> <ul style="list-style-type: none"> • If yes, continue with step 5. • If no, continue with step 7. 	
5.	<p>The edited point is <Class: MEAS>.</p> <p>PAGE (F6) changes to the Obs page.</p>	
6.	<p>MANAGE Edit Point: Point ID, Obs page</p> <p>For GPS points</p> <p>The name of the real-time reference station from where the GPS point was measured, the name of antenna used to measure the point and the baseline values are shown in output/observations fields.</p> <p>For TPS points</p> <p>It is possible to edit the reflector height.</p> <p>The name of the station from where the point was measured is shown in an output field.</p> <p> Changing the reflector height recalculates the point height.</p>	
	<p>MORE (F5) Available for TPS points. Displays the horizontal angle or the azimuth from the point to the instrument.</p>	

Step	Description	Refer to chapter
7.	PAGE (F6) changes to the Code page.	
8.	<p>MANAGE Edit Point: Point ID, Code page</p> <p>The point code can be edited. All point codes in the job can be selected.</p> <p>The description of the code is shown as an output field.</p> <p>The attributes are shown as output, input or choicelist fields depending on their definition.</p> <p>The attribute values shown depend on <Attributes:> in CONFIGURE Coding & Linework. <Attributes: Last Used> shows the last used attribute values which are stored for this point code in the active codelist. <Attributes: Default Values> shows the default attribute values for this point code if existing.</p>	11.2 and 11.3
	NEW-A (F2) allows additional attributes to be created for this point code.	
	<p>NAME (F3) or VALUE (F3)</p> <p>Available for attributes for which an attribute name can be typed in. To highlight <Attribute n:> or the field for the attribute value. The name of <Attribute n:> can be edited and an attribute value can be typed in.</p>	
	LAST (F4) recalls the last used attribute values which were stored with this point code.	

Step	Description	Refer to chapter
	DEFLT (F5) recalls the default attribute values for the selected code.	
9.	Is <Class: MEAS> and no offset point or <Class: NAV> ? <ul style="list-style-type: none"> • If yes, continue with step 11. • If no, continue with step 10. 	
10.	Is <Class: AVGE> ? <ul style="list-style-type: none"> • If yes, continue with step 13. • If no, continue with step 15. 	
11.	The edited point is <Class: MEAS> and no offset point or <Class: NAV> . PAGE (F6) changes to the Annots page.	
12.	MANAGE Edit Point: Point ID, Annots page The comments to be stored with the point can be edited except for <4:> if a GPS seismic value has been recorded. Continue with step 15.	19.7
13.	The edited point is <Class: AVGE> . PAGE (F6) changes to the Mean page.	
14.	MANAGE Edit Point: Point ID, Mean page All points of <Class: MEAS> of the same point ID are listed sorted by time. The settings in the Use column can be edited. All functionality and keys are explained in a separate section.	9.3.4

Step	Description	Refer to chapter
15.	<p>STORE (F1) stores the changes and returns to MANAGE Data: Job Name.</p> <p> An edited point retains the creation value for <Time:>.</p> <p> Changing coordinates of a point which has been previously used in other application programs, for example COGO, or hidden point measurements does not update the application results.</p>	
	It may happen that a point with the same point ID exists in the job. If the codes and/or attribute values of the new and the existing point do not match, a screen opens where they can be corrected.	11.6

9.3.4

Mean Page

Description

In order to check measurements, the same point can be measured more than once. These measured points are assigned the class **MEAS**. The various measured coordinate triplets for one point can be recorded using the same point ID. If the averaging mode is activated, an average is calculated when more than one measured coordinate triplet is available for the same point ID.

The averaged point is given the class **AVGE**. It is checked if the deviations of each single point are within the limits configured in **MANAGE New Job, Avge** page or in **MANAGE Edit Job: Job Name, Avge** page.

After averaging, the **Mean** page becomes available in **MANAGE Edit Point: Point ID** and accessible from the Survey application program **SURVEY Survey: Job Name, Survey** page.

Available functionality on the **Mean** page depends on the selected averaging mode.

Averaging

Averaging Mode

The averaging mode defines the checks which are performed when more than one set of measured coordinates are recorded for the same point. The selected averaging mode also affects the behaviour of the instrument when editing a point and calculating averages.

Defining the averaging mode and configuring the limits

The averaging mode and the limits are configured in **MANAGE New Job, Avge** page or in **MANAGE Edit Job: Job Name, Avge** page. Refer to "8.3 Creating a New Job". Refer to "8.4 Editing a Job".

Description of averaging modes

Averaging mode	Description
Average	<p>When more than one measured coordinate triplet is recorded for the same point, the average for the position and the height is computed. Depending on the selected averaging method, the average will be computed weighted or arithmetic (no weighting). The class AVGE is assigned to the averaged point.</p> <p>The horizontal and height distances from the measured points to the average are computed and displayed on the Mean page.</p> <p>A check is performed that the differences for the position and height components between the averaged point and the point being stored does not exceed the defined limits.</p>
Absolute Diffs	<p>What is described above for Average applies for Absolute Diffs. Additionally, the absolute difference between two points selected from a list of measured points which are all stored with the same point ID are computed and checked for being within the defined limits.</p>
Off	<p>Averaging functionality is turned off.</p> <p>With more than one measured coordinate triplet recorded for the same point, no average for the position and the height is computed.</p>

Averaging with position only or height only points

Position only points, height only points and points with full coordinate triplets are handled in the averaging.

Access step-by-step

The **Mean** page can be accessed if

<**Averaging Mode: Average**> or <**Averaging Mode: Absolute Diffs**> is configured in **MANAGE New Job, Avge** page or in **MANAGE Edit Job: Job Name, Avge** page.

AND

more than one measured coordinate triplet is recorded for the same point using the same point ID.

Access within data management

Step	Description
1.	Refer to "9.2 Accessing Data Management" to access MANAGE Data: Job Name .
2.	In MANAGE Data: Job Name, Points page highlight a point to be edited.
3.	EDIT (F3) to access MANAGE Edit Point: Point ID, Mean page.

Access within Survey

From within the Survey application program, the **Mean** page is accessible for <**R-Time Mode: Rover**>.

Step	Description
1.	Main Menu: Survey to access SURVEY Survey Begin .
2.	CONT (F1) to access SURVEY Survey: Job Name, Survey page.
3.	SHIFT AVGE (F2) or SHIFT ABS (F2) to access SURVEY Edit Point: Point ID, Mean page.

MANAGE

**Edit Point: Point ID,
Mean page**

All measured coordinate triplets recorded using the same point ID are shown.

11:49				
MANAGE				
Edit Point: 100				
Coords	Code	Mean		
Use	Time	dPos	dHt	
Auto	11:48:52	0.0010	0.0068	!
Auto	11:39:05	0.0016	0.0039	!
Auto	11:38:11	0.0000	0.0000	

Q1 a ↑

STORE	USE	EDIT	DEL	MORE	PAGE
-------	-----	------	-----	------	------

STORE (F1)

To store the changes and to return to the screen from where this screen was accessed.

USE (F2)

To change between the options in the **Use** column for the highlighted coordinate triplet. To include or exclude this triplet in or from the calculation of the average. Refer to "Description of columns" below.

EDIT (F3)

To view and edit the highlighted measured coordinate triplet. It is possible to edit the point ID and the antenna height without impact on all other classes of the point with the same original name. The coordinates are updated. Codes cannot be changed. The average point has the higher priority. A change in codes must be an overall change for the average point.

Example: One of the measured coordinate triplets has a wrong point ID and should not be included in the average. By editing the point ID, the point is renamed and no longer contributes to the average.

DEL (F4)

To delete the highlighted coordinate triplet. The average is recomputed.

MORE (F5)

To change between time and date of when the point was stored and the 3D coordinate quality.

PAGE (F6)

To change to another page on this screen.

SHIFT DIFFS (F5)

Available for **<Averaging Mode: Absolute Diffs>** and **Yes** is set in the **Use** column for exactly two measurements. To display the absolute coordinate differences when a local coordinate system is active. Differences exceeding the defined limit are indicated by **!**.

Description of columns

Column	Description
Use	<p>The use of a measured coordinate triplet in the averaging.</p> <ul style="list-style-type: none"> Auto The coordinate triplet is included in the averaging computation if within the averaging limit defined in MANAGE New Job, Avge page or in MANAGE Edit Job: Job Name, Avge page.

Column	Description
	<ul style="list-style-type: none"> <li data-bbox="635 176 1495 337">• Yes The coordinate triplet is always included in the averaging computation even if it would fall outside the averaging limit defined in MANAGE New Job, Avge page or in MANAGE Edit Job: Job Name, Avge page. <li data-bbox="635 351 1495 415">• No The coordinate triplet is never included in the averaging computation. <li data-bbox="635 430 1495 527">• ---- The coordinate triplet cannot be included in the averaging computation. Automatically set by the system. <p data-bbox="635 542 1107 568">USE (F2) changes between the options.</p>
Time	The time the measured coordinate triplet was stored.
Date	The date the measured coordinate triplet was stored. The format is as defined in CONFIGURE Units & Formats, Time page.
dPos	The horizontal distance from the measured coordinate triplet to the average. <dPos: ----> indicates unavailable information, for example for a height only point.
dHt	The height distance from the measured coordinate triplet to the average. <dHt: ----> indicates unavailable information, for example for a position only point.
!	Available for measured coordinate triplets with Auto or Yes in the Use column if <Averaging Mode: Average> . Indicates an exceeding of the limits.

Next step

IF a measured coordinate triplet	THEN
is not to be viewed	STORE (F1) stores the changes and returns to MANAGE Data: Job Name .
is to be viewed	highlight a measured coordinate triplet and EDIT (F3) .

9.4 Line/Area Management

9.4.1 Overview

Description

A line/area consists of points and can be created/edited in **MANAGE Data: Job Name**. The individual points are measured within any application program. These can be all points except auxiliary points. Points can be simultaneously assigned to one or more lines and/or areas.

A line/area can have

- a style for display in MapView.
- a code independent of the point code of the points comprising the line/area.



Points are assigned to a line/area when the line/area is open. Refer to "9.2 Accessing Data Management" for information on how to open a line/area.

9.4.2

Creating a New Line/Area



The functionality of all screens and fields are similar for the creation of both lines and areas. The step-by-step instructions for creating a new line can be applied for areas.

Access

Refer to "9.2 Accessing Data Management" to access **MANAGE Data: Job Name**.

OR





Press a hot key configured to access the screen **MANAGE New Line/MANAGE New Area**. Refer to "6.1 Hot Keys" for information on hot keys.

Create line step-by-step

The following table explains the most common settings. Refer to the stated chapter for more information on screens.

Step	Description	Refer to chapter
1.	MANAGE Data: Job Name	
2.	PAGE (F6) until the Lines (X) page is active.	
3.	MANAGE Data: Job Name, Lines (X) page	
4.	NEW (F2) to access MANAGE New Line .	
5.	MANAGE New Line, General page <Line ID:> The name of the new line. The configured ID template for lines is used. The ID can be changed in the following ways: <ul style="list-style-type: none">• To start a new sequence of line ID's type over the line ID.• For an individual name independent of the ID template SHIFT INDIV (F5). SHIFT RUN (F5) changes back to the next ID from the configured ID template.	

Step	Description	Refer to chapter
	<p><Pts to Store:> The type of points which are used to form the line during a survey. Select between all points, measured points, auto points and offset points of type 1 or 2.</p> <p><Line Style:> This is the line style in which lines/areas are represented in MapView and LGO. For <Line Code: <None>> on the Code page a line style can be selected from a choicelist. Otherwise the line style as defined for the selected line code is shown.</p> <p>Type in a number for the line, select the points to be stored with the line and select a line style if necessary.</p>	45.1, 45.4
6.	PAGE (F6) changes to the Code page.	
7.	<p>MANAGE New Line, Code page</p> <p>The setting for <Thematc Codes:> in CONFIGURE Coding & Line-work determines the availability of the subsequent fields and softkeys.</p> <ul style="list-style-type: none"> • For <Thematc Codes: With Codelist>: The codes from the job codelist are used. <p><Line Code:> All line codes of the job codelist can be selected. The description of the code is shown as an output field. The line style is shown as defined for the selected line code. It is the style in which lines/areas are represented in MapView and LGO. For <Line Code: <None>>, it can be changed. The attributes are shown as output, input or choicelist fields depending on their definition.</p>	19.3

Step	Description	Refer to chapter
	<ul style="list-style-type: none"> • For <Thematc Codes: Without Codelist>: Codes for lines can be typed in but not selected from a codelist. • <Line Code:> The line code to be stored with the point. A check is performed to see if a line code of this name already exists in the job. If so, the according attributes are displayed. • <Attribute n:> Up to eight attribute values are available. <p>Type in a code.</p>	
8.	<p>Is <Thematc Codes: With Codelist>?</p> <ul style="list-style-type: none"> • If yes, continue with the next row. • If no, continue with step 9. 	
	NEW-A (F2) allows additional attributes to be created for this line code.	
	NAME (F3) or VALUE (F3) Available for attributes for which an attribute name can be typed in. To highlight <Attribute n:> or the field for the attribute value. The name of <Attribute n:> can be edited and an attribute value can be typed in.	
	LAST (F4) recalls the last used attribute values which were stored with this line code.	
	DEFLT (F5) recalls the default attribute values for the selected code.	
9.	STORE (F1) stores the new line entered and all associated information and returns to MANAGE Data: Job Name, Lines (X) page.	

Step	Description	Refer to chapter
	The value for <Start Time:> with which the line is stored is the time when STORE (F1) was pressed. The same value is assigned to the value for <End Time:> until a point is added to the line.	9.4.3
	Any existing lines and areas which are open are closed.	

Creating lines/areas most efficiently

IF the task is to create	THEN
multiple lines/areas with subsequent line/area ID's	use the hot key/user menu function FUNC Create New Line (Quick)/FUNC Create New Area (Quick) . Pressing the hot key or selecting the function from the user menu creates and immediately stores the new line/area. For the line/area ID, the line/area ID template as defined in CONFIGURE ID Templates is used. The code and attributes are taken over from the last created line/area.
lines/areas with certain codes	use quick coding. The job codelist must contain quick codes for lines/areas. By tying the quick code a new line/area is created and immediately stored with that line/area code and attributes. For the line/area ID, the line/area ID template as defined in CONFIGURE ID Templates is used.

9.4.3

Editing a Line/Area



The functionality of all screens and fields are similar for the editing of both lines and areas. The step-by-step instructions for editing a new line can be applied for areas.







Access





Refer to "9.2 Accessing Data Management" to access **MANAGE Data: Job Name**.

Edit line step-by-step

The following table explains the most common settings. Refer to the stated chapter for more information on screens.

Step	Description	Refer to chapter
1.	MANAGE Data: Job Name	
2.	PAGE (F6) until the Lines (X) page is active.	
3.	In MANAGE Data: Job Name, Lines (X) page highlight a line to be edited.	
4.	EDIT (F3) to access MANAGE Edit Line: Line ID .	
5.	MANAGE Edit Line: Line ID, General page The line ID and the type of points which are used to form the line during a survey can be edited. Other line related data is shown in output fields. <No. of Pts:> The number of points contained within the line. <Length:> The sum of the distances between the points in the sequential order in which they are stored for the line. This can be a horizontal grid distance or a geodetic distance on the WGS 1984 ellipsoid.	

Step	Description	Refer to chapter
	<p><Start Time:> and <Start Date:> The time/date when the line was created.</p> <p> A line cannot be renamed to an already existing line ID.</p>	
	<p>MORE (F5) displays <End Time:> and <End Date:>. This is the time/date when the last point was added to the line. This can be different to the time the point was created. The values do not change after deleting the last added point or after editing unless an additional point is added to the line.</p>	
6.	<p>PAGE (F6) changes to the Points page.</p>	
7.	<p>MANAGE Edit Line: Line ID, Points page</p> <p>All points belonging to the line are listed. The point that was added last to the line is at the top of the list.</p>	
	<p>ADD (F2) Accesses MANAGE Select Point with the Points and Map page. To add an existing point from the active job to the line. A new point is added above the point which was highlighted when ADD (F2) was pressed.</p>	9.2
	<p>EDIT (F3) edits the highlighted point.</p>	9.3.3
	<p>REMOV (F4) removes the highlighted point from the line. The point itself is not deleted.</p>	
	<p>MORE (F5) displays information about the point codes if stored with the line, the time and the date of when the line was stored, the 3D coordinate quality, the class and the flag for Linework.</p>	9.3.1

Step	Description	Refer to chapter
8.	PAGE (F6) changes to the Code page.	
9.	<p>MANAGE Edit Line: Line ID, Code page</p> <p>The line code can be edited. All line codes can be selected. For <Line Code: <None>>, the line style can be changed.</p> <p>The description of the code is shown as an output field.</p> <p>The attributes are shown as output, input or choicelist fields depending on their definition.</p>	11
	NEW-A (F2) allows additional attributes to be created for this line code.	
	<p>NAME (F3) or VALUE (F3)</p> <p>Available for attributes for which an attribute name can be typed in. To highlight <Attribute n:> or the field for the attribute value. The name of <Attribute n:> can be edited and an attribute value can be typed in.</p>	
	LAST (F4) recalls the last used attribute values which were stored with this line code.	
	DEFLT (F5) recalls the default attribute values for the selected code.	
10.	STORE (F1) stores the changes and returns to MANAGE Data: Job Name, Lines (X) page.	
	An edited line retains the creation value for <Start Time:> . The value for <End Time:> changes when a point was added to the line.	

9.4.4

Working Example

Description

Application:	Pick up points along fence lines with a gate. The gate can also be represented as a line. Some points belong to more than one line.
Working technique:	Real-time kinematic.
Setting:	F7 is configured to access the MANAGE Data: Job Name screen. Refer to "6.1 Hot Keys" on how to configure hot keys.
Goal:	Each point is to be picked up once.

Diagram

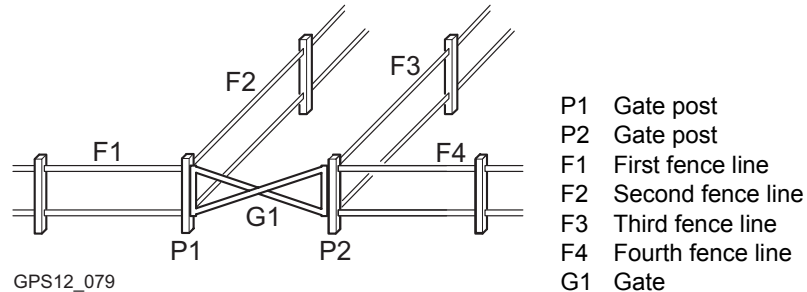



Requirements

- A real-time reference is running.
- For the rover: **<R-Time Mode: Rover>** in **CONFIGURE Real-Time Mode**.

Field procedure step-by-step

The following table explains the most common settings. Refer to the stated chapter for more information on screens.

Step	Description	Refer to chapter
1.	Create the lines F1, F2 and G1.	9.2
2.	Start Survey application program for a real-time rover.	44.3.3
3.	Press F7 .	
4.	MANAGE Data: Job Name, Lines (X) page The line F1 must be open, the lines F2 and G1 must be closed. To open/close a line, highlight the line and CLOSE (F4) and OPEN (F4) .	
5.	CONT (F1)	
6.	SURVEY Survey: Job Name	44.3.3
	Measure points along fence line F1 until the last point before P1. These points are automatically added to line F1.	
	Points can be coded separately.	
7.	Press F7 .	
8.	MANAGE Data: Job Name, Lines (X) page Highlight the line F2. OPEN (F4) to open the line.	
9.	Highlight the line G1. OPEN (F4) to open the line.	
	Line F1 stays open.	

Step	Description	Refer to chapter
10.	CONT (F1)	
11.	SURVEY Survey: Job Name Measure P1. This point is automatically added to all three lines open at that time.	44.3.3
12.	Press F7 .	
13.	MANAGE Data: Job Name, Lines (X) page Highlight the line F1. CLOSE (F4) to close the line.	
14.	Highlight the line F2. CLOSE (F4) to close the line.	
	Line G1 stays open.	
15.	CONT (F1)	
16.	SURVEY Survey: Job Name Measure points along gate G1. These points are automatically added to line G1.	44.3.3
17.	After finishing the survey, import the data into a CAD package. If the line codes required by the CAD package were used, the lines are automatically connected and the point symbols are automatically set.	

9.5

Data Log

Description

A list of all objects and free codes in the active job is displayed in order of time.

Access step-by-step

Access within data management

Step	Description
1.	Refer to "9.2 Accessing Data Management" to access MANAGE Data: Job Name .
2.	In MANAGE Data: Job Name on the Points page, SHIFT LOG (F4) to access MANAGE Data Log: Job Name .

Access within job management

Step	Description
1.	Main Menu: Manage...\Jobs to access MANAGE Jobs (Device) . Refer to "8.2 Accessing Job Management" for further options to access this screen.
2.	In MANAGE Jobs (Device) highlight a job to be edited.
3.	EDIT (F3) to access MANAGE Edit Job: Job Name .
4.	SHIFT LOG (F5) to access MANAGE Data Log: Job Name .

Access by hot key

Press a hot key configured to access the screen **MANAGE Data Log: Job Name**. Refer to "6.1 Hot Keys" for information on hot keys.

Access by user defined menu

Press **USER**. Refer to "6.2 USER Key" for information on the **USER** key.

MANAGE

Data Log: Job Name

In the column **Data Record**, all points, lines and areas as well as free codes stored within the active job are displayed. They are always sorted by time with the most recent record at the top. For lines and areas, the value for **<Start Time:>** is relevant.

Data Record	Record Type
400	Point
300	Point
200	Point
101	Point
200	Line
100	Line
ant4	Point

CONT (F1)

To close the screen and return to the screen from where this screen was accessed.

NEW (F2)

To insert a free code below, this means time-wise before, the currently highlighted object or record. The functionality of inserting a free code is identical to the functionality of entering a free code during a survey. Refer to "11.3 Free Coding".

EDIT (F3)

To edit the highlighted object or free code. Refer to "9.3.3 Editing a Point", "9.4.3 Editing a Line/Area". The functionality of editing a free code is identical to the functionality of entering a free code during a survey. Refer to "11.3 Free Coding".

DEL (F4)

To delete the highlighted object or free code.

MORE (F5)

To display information about the type of data recorded, the time and the date of when it was stored or for lines and areas when they were created and the codes if stored with any object.

Next step

CONT (F1) returns to the screen from where **MANAGE Data Log: Job Name** was accessed.

9.6 Point Sorting and Filters

9.6.1 Sorting and Filters for Points, Lines and Areas

Description

The sort settings define the order of the objects in the active job. The filter settings define the objects to be viewed.

Three types of filters are available:

Point filter: An active point filter shows selected points in **MANAGE Data: Job Name, Points** page.

Line filter: An active line filter shows selected lines in **MANAGE Data: Job Name, Lines (X)** page.

Area filter: An active area filter shows selected areas in **MANAGE Data: Job Name, Areas (X)** page.



The sort and filter settings are stored in the job. They are remembered after turning off the instrument.



Changing the active job does influence the sort settings for the objects. The filter settings are set to those of the selected job.



An active filter for an object is indicated in **MANAGE Data: Job Name** by φ located on the right hand side of the page name.

Access step-by-step

Step	Description
1.	Refer to "9.2 Accessing Data Management" to access MANAGE Data: Job Name .

Step	Description
2.	In MANAGE Data: Job Name on the Points, Lines (X) or Areas (X) page, SHIFT FILT (F5) to access MANAGE Sorts & Filters .
3.	MANAGE Sorts & Filters  This screen consists of three pages, one for each type of object. The page for an object is displayed when the equivalent page is displayed in MANAGE Data: Job Name .

**MANAGE
Sorts & Filters,
Points page**

The available fields on this screen depend on the selected setting for **<Filter:>**.

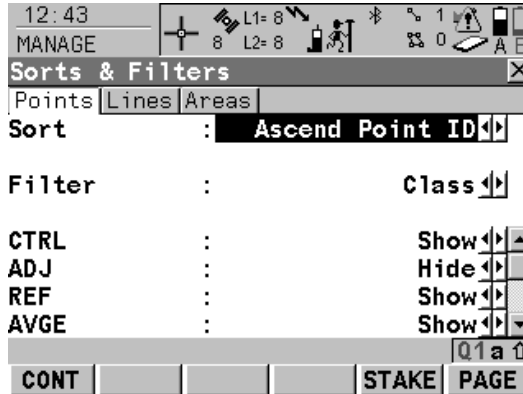

CONT (F1)

To close the screen and return to the screen from where this screen was accessed. The selected sort and filter settings are applied.

STAKE (F5)

To filter points for the Stakeout application program. Refer to "9.6.3 Stakeout Filter".

PAGE (F6)

To change to another page on this screen.

Description of fields

Field	Option	Description
<Sort:>	Ascend Point ID, Descend Point ID, Forward Time or Backward Time	Always available. The method points are sorted by.
<Filter:>	No Filter Highest Class Range of Pt ID's Pt ID Wildcard Time Class Instrument Coordinate Type Point Code	<p>Always available. The method the points are filtered by.</p> <p>Shows all points.</p> <p>Shows points of highest class.</p> <p>Shows points with point ID's between the entered start and end ID. The points are left aligned and sorted by the first digit.</p> <p>Shows points with point ID's matching the wildcard.</p> <p>Shows points which were recorded within a defined time window.</p> <p>Shows points of the selected class.</p> <p>Shows points originating from the selected instrument or software program type.</p> <p>Shows points of the selected type of coordinates.</p> <p>Shows points with selected codes attached. Refer to "9.6.2 Point, Line and Area Code Filter".</p>

Field	Option	Description
	Radius From Pt	Shows points within the defined radius from a particular point. The radius is the horizontal distance.
	Individual Line	Shows points forming a selected line. This may for example be useful during stakeout.
	Individual Area	Shows points forming a selected area. This may for example be useful during stakeout.
<Start ID:>	User input	Available for <Filter: Range of Pt ID's> . The first point to be displayed.
<End ID:>	User input	Available for <Filter: Range of Pt ID's> . The last point to be displayed.
<Wildcard:>	User input	Available for <Filter: Pt ID Wildcard> . * and ? are supported. * indicates an undefined number of unknown characters. ? indicates a single unknown character.
<Start Date:>	User input	Available for <Filter: Time> . The date of the first point to be displayed.
<Start Time:>	User input	Available for <Filter: Time> . The time of the first point to be displayed.
<End Date:>	User input	Available for <Filter: Time> . The date of the last point to be displayed.
<End Time:>	User input	Available for <Filter: Time> . The time of the last point to be displayed.

Field	Option	Description
<CTRL:> <ADJ:> <REF:> <AVGE:> <MEAS:> <NAV:> <EST:> <NONE:>	Show or Hide	Available for <Filter: Class >. Defined classes are shown or hidden.
<View:>	Highest Triplet All Triplets	Available for <Filter: Class >. The coordinate triplets of the highest class are shown. All classes for one coordinate triplet are shown.
<Instrument:>	All, TPS, GPS, LEICA Geo Office, Level, Data Logger, Third Party SW or Unknown	Available for <Filter: Instrument >. Points originating from this instrument type are shown.
<Type:>	WGS84 Only or Local Only	Available for <Filter: Coordinate Type >. Points from the chosen coordinate type are shown.
<Point ID:>	Choicelist	Available for <Filter: Radius From Pt >. The point to which the radius is applied. Opening the choicelist opens MANAGE Data: Job Name . Refer to "9.2 Accessing Data Management".

Field	Option	Description
<Radius:>	User input	Available for <Filter: Radius From Pt>. The radius of the circle within which the points are shown.
<Line ID:>	Choicelist	Available for <Filter: Individual Line>. Opening the choicelist opens MANAGE Data: Job Name . Refer to "9.2 Accessing Data Management".
<Area ID:>	Choicelist	Available for <Filter: Individual Area>. Opening the choicelist opens MANAGE Data: Job Name . Refer to "9.2 Accessing Data Management".

Next step

PAGE (F6) changes to the **Lines** page. Refer to paragraph "MANAGE Sorts & Filters, Lines page".

MANAGE
Sorts & Filters,
Lines page

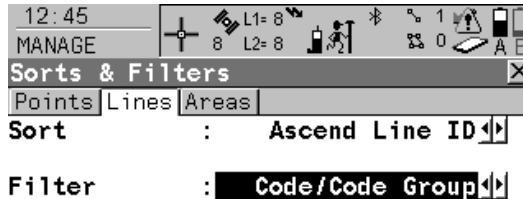

CONT (F1)

To close the screen and return to the screen from where this screen was accessed. The selected sort and filter settings are applied and the lists in **MANAGE DATA: Job Name** are updated.

CODES (F4)

Available for **<Filter: Code/Code Group>**. To select the line codes to be used.

PAGE (F6)

To change to another page on this screen.



Description of fields

Field	Option	Description
<Sort:>	Ascend Line ID, Descend Line ID, Fwrd Start Time, Bwrd Start Time, Fwrd End Time, Bwrd End Time	Always available. The method the lines are sorted by.
<Filter:>	No Filter	Always available. The method by which the lines are filtered. Shows all lines.

Field	Option	Description
	Code/Code Group	Shows lines with selected codes attached. Refer to "9.6.2 Point, Line and Area Code Filter" since the functionality is identical to the point code filter.

Next step

PAGE (F6) changes to the **Areas** page. Refer to paragraph "MANAGE Sorts & Filters, Areas page".

MANAGE Sorts & Filters, Areas page

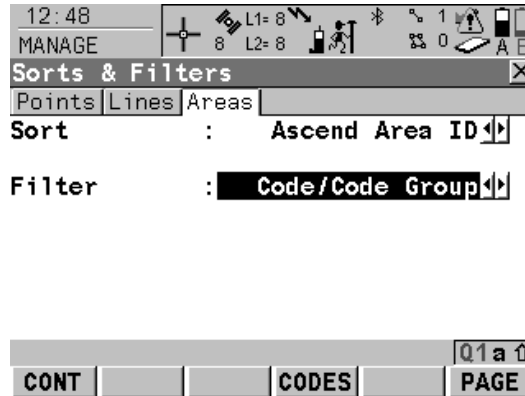

CONT (F1)

To close the screen and return to the screen from where this screen was accessed. The selected sort and filter settings are applied and the lists in **MANAGE DATA: Job Name** are updated.

CODES (F4)

Available for **<Filter: Code/Code Group>**. To select the area codes to be used.

PAGE (F6)

To change to another page on this screen.

Description of fields

The functionality of setting the filters is identical to those on the **Lines** page. Refer to paragraph "MANAGE Sorts & Filters, Lines page".

Next step

CONT (F1) returns to the screen from where **MANAGE Sorts & Filters** was accessed.

9.6.2

Point, Line and Area Code Filter



For each object, a code filter exists. The point, line and area code filters are independent from each other. The functionality is identical. For simplicity, the point code filter is explained.

Access step-by-step

Step	Description
1.	Refer to "9.6.1 Sorting and Filters for Points, Lines and Areas" to access MANAGE Sorts & Filters .
2.	Select <Filter: Point Code> .
3.	CODES (F4) to access MANAGE Point Code Filter .

MANAGE Point Code Filter

This screen shows the point codes from the active job and codes currently used as filter. Point codes are sorted according to the settings in **MANAGE Sort Codes**.



CONT (F1)

To close the screen and return to the screen from where this screen was accessed.

GROUP (F4)

To activate and deactivate code groups. Accesses **MANAGE Code Groups**. Any code group that have been previously deactivated are displayed as deactivated here. Codes belonging to a deactivated code group are not displayed in **MANAGE Code Filter**. Refer to "10.6 Managing Code Groups".

USE (F5)

To activate and deactivate the filter for the highlighted code.

NONE (F6) or ALL (F6)

To deactivate or activate all point codes.

SHIFT SORT (F5)

To define the order of the codes. Accesses **MANAGE Sort Codes**.

9.6.3

Stakeout Filter

Description

The settings on this screen define a filter for the Stakeout application program, for example to show points which are already staked or points that are still to be staked.



The stakeout filter acts in addition to any other filter set in **MANAGE Sorts & Filters**. For example, points still to be staked out with a particular code can be filtered.

Access step-by-step

Step	Description
1.	Refer to "9.6.1 Sorting and Filters for Points, Lines and Areas" to access MANAGE Sorts & Filters .
2.	In MANAGE Sorts & Filters , PAGE (F6) until the Points page is active.
3.	STAKE (F5) to access MANAGE Stakeout Filter .

MANAGE Stakeout Filter

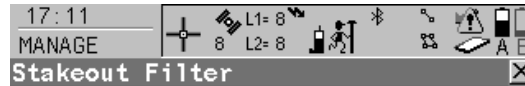

View : **Pts to Stakeout**



CONT (F1)

To close the screen and return to the screen from where this screen was accessed.

RESET (F4)

To reset the staked flag for all points of the currently active job.

Description of fields

Field	Option	Description
<View:>	All	Shows all points.
	Pts to Stakeout	Shows points not yet staked out.
	Staked Points	Shows points which are already staked out.

10**Manage...\Codelists****10.1****Terminology****Description**

This chapter describes technical terms related to codes and codelists.



The values for code groups, codes and attributes are case sensitive. For example the code group Tree is not the same as the code group TREE.

Object

For coding, points, lines and areas have the same behaviour. In this chapter, object is used as generic term for points, lines and areas.

Code group

A code group allows codes belonging to the same theme to be grouped together. Individual groups can be activated or deactivated. The codes belonging to a deactivated code group cannot be selected from the choicelist for code selection.

Code**Description**

A code is a description which can be stored with an object or alone.

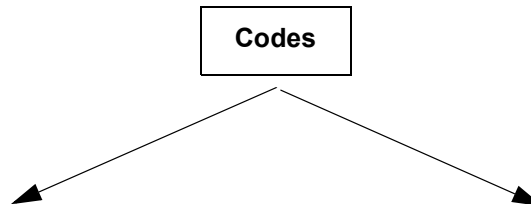
Structure of codes

Thematical codes:
Object related information recorded together with the actual object in the field.



Code type:
Point code **Line code** **Area code**



Optional:
Quick code

Free codes:
Time related information recorded between objects in the field. A time stamp is recorded with each free code. It allows to export free codes and objects in a chronological order to be used for third party mapping software.

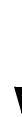

Code type:
Free code



Optional:
Quick code

Code types

The code type defines how and for which objects a code can be used. It is possible to create a code of the same name but of different code types both on the receiver and in LGO.

Example: The code Oak can exist with code type point code and with code type line code.

- Point code: To record a code directly with a point. This is thematic point coding.
Line code: To record a code directly with a line. This is thematic line coding.
Area code: To record a code directly with an area. This is thematic area coding.
Free code: To record a code based on time in between objects.
Quick code: To start a point occupation and store the code by typing in one, two or three predefined digits.

Attribute

Description

The use of attributes allows additional information to be stored with the code. Up to twenty attributes can be related to one code. Attributes are not compulsory.

Structure of attributes

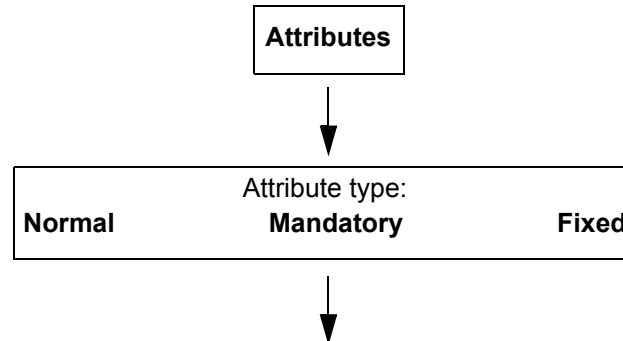

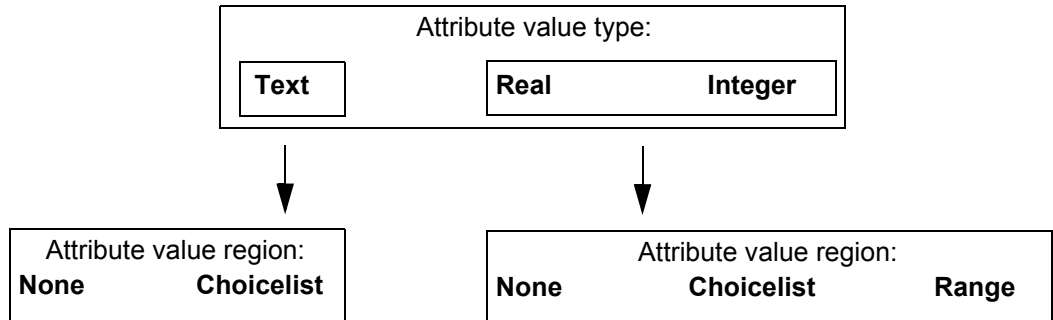

Attribute types

The attribute type defines the input requirements for the attribute.

- Normal: An input for the attribute is optional. The attribute value can be typed in the field. New attributes with this attribute type can be created in LGO or on the receiver.
- Mandatory: An input for the attribute is compulsory. The attribute value must be typed in the field. New attributes with this attribute type can be created in LGO.
- Fixed: The attribute value is a predefined default which is displayed but cannot be changed in the field. This attribute value is automatically attached to the code. New attributes with this attribute type can be created in LGO.

Attribute value types

The attribute value type defines which values are accepted as input.

- Text:** Any input for the attribute is interpreted as text. New attributes with this attribute value type can be created in LGO or on the receiver.
- Real:** An input for the attribute must be a real number, for example 1.23. New attributes with this attribute value type can be created in LGO.
- Integer:** An input for the attribute must be an integer number, for example 5. New attributes with this attribute value type can be created in LGO.

Attribute value regions

The attribute value region defines if the attribute values must be selected from a predefined list.

- None:** An input for the attribute must be typed in. New attributes with this attribute value region can be created in LGO or on the receiver.
- Range:** An input for the attribute must fall within a predefined range. New attributes with this attribute value region can be created in LGO.
- Choicelist:** An input for the attribute is selected from a predefined list. New attributes with this attribute value region can be created in LGO.

Example

Code	Attributes	Attribute value type	Attribute value region	Example for the attribute value region
Birch	Height	Real	Range	0.5-3.0
	Condition	Text	Choicelist	Good, Dead, Damaged
	Remark	Text	None	-

Codelist

Description

A codelist is a collection of codes that can be used to describe surveyed objects in the field.

Elements of a codelist

- Code group
- Code
- Attributes

Structure of a codelist

Structure	Example
<p>Codelist</p> <pre> graph LR Root[Codelist] --- CG1[Code group 1] Root --- CG2[Code group 2] CG1 --- C11[Code 1.1] CG1 --- C12[Code 1.2] CG1 --- C13[Code ...] C11 --- A111[Attribute 1.1.1] C11 --- A112[Attribute ...] C11 --- A113[Attribute 1.1.20] C12 --- A121[Attribute 1.2.1] C12 --- A122[Attribute ...] C12 --- A123[Attribute 1.2.20] C13 --- ...1[] CG2 --- C21[Code 2.1] C21 --- A211[Attribute 2.1.1] C21 --- ...2[] </pre>	<p>Codelist</p> <pre> graph LR Root[Codelist] --- Trees[Trees] Root --- Infra[Infrastructure] Trees --- Birch[Birch] Trees --- Oak[Oak] Trees --- ...T[] Birch --- Height[Height] Birch --- ConditionB[Condition] Birch --- Remark[Remark] Oak --- Circumference[Circumference] Oak --- ConditionO[Condition] Oak --- ...O[] Infra --- Road[Road] Road --- Material[Material] Road --- ...R[] </pre>

Codelist types

System RAM codelist:

A codelist stored in the System RAM of the instrument.

Job codelist:

The collection of codes contained within the currently active job.

10.2

Overview



It is recommended to create a codelist in LGO. A codelist can be transferred from LGO to the System RAM of the receiver using the CompactFlash card.

Steps from creating to using a codelist

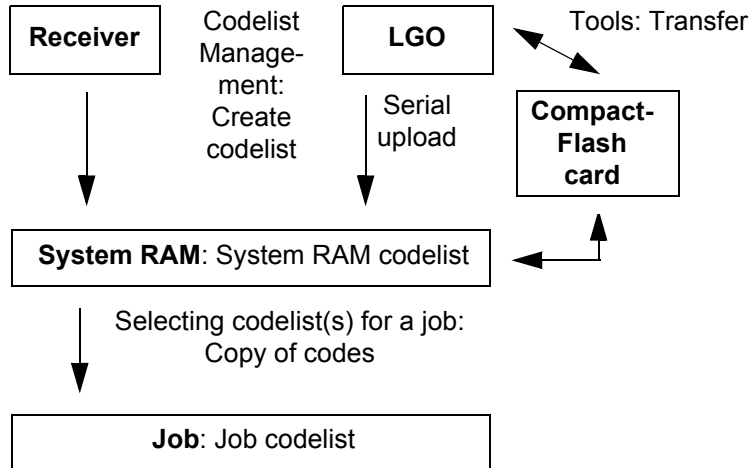

The creating, editing and managing of codelists is explained in this chapter. In order to use a codelist on the receiver, it must be transferred from the CompactFlash card to the System RAM. Refer to "26 Tools...\Transfer Objects...".

10.3

Accessing Codelist Management

Access

Select **Main Menu: Manage...\Codelists**.

OR

From a choicelist in some screens, for example **MANAGE New Job, Codelist** page.

MANAGE Codelists

Listed are all codelists stored in the System RAM.

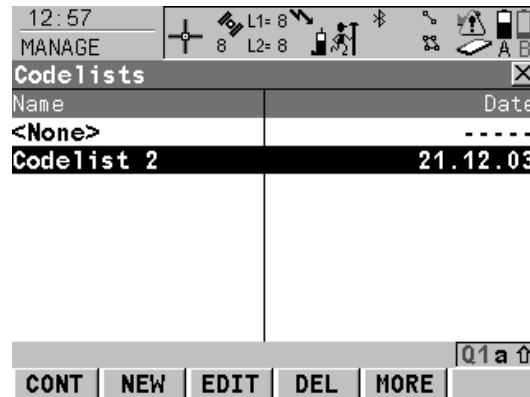

CONT (F1)

To return to the screen from where this screen was accessed. If this screen was accessed from a choicelist, the codes from the highlighted codelist are copied to the active job.

NEW (F2)

To create a codelist. Refer to "10.4 Creating/Editing a Codelist".

EDIT (F3)

To edit the highlighted codelist. Refer to "10.4 Creating/Editing a Codelist".

DEL (F4)

To delete the highlighted codelist.

MORE (F5)

To display information about the creator and the date of when the codelist was created.

Next step

IF a codelist	THEN
is to be selected	highlight the desired codelist. CONT (F1) copies the codes of the codelist to the active job, closes the screen and returns to the screen from where MANAGE Codelists was accessed.
is to be created	NEW (F2) . Refer to "10.4 Creating/Editing a Codelist".
is to be edited	highlight the codelist and EDIT (F3) . Refer to "10.4 Creating/Editing a Codelist".

10.4

Creating/Editing a Codelist

Access

Refer to "10.3 Accessing Codelist Management" to access **MANAGE Codelists**.

Create/edit a codelist step-by-step

The following table explains the most common settings. Refer to the stated chapter for more information on screens.

Step	Description	Refer to chapter
1.	MANAGE Codelists NEW (F2) or EDIT (F3)	10.3
2.	MANAGE New Codelist or MANAGE Edit Codelist <Name:> A unique name for the codelist. The name may be up to 16 characters long and may include spaces. Input required. <Description:> A detailed description of the codelist. This can be for example, work to be performed. Input optional. <Creator:> The person's name who is creating the new codelist. Input optional.	
	CODES (F4) accesses MANAGE Codes where codes can be created, edited or deleted and code groups can be accessed.	10.5.2, 10.5.3 or 10.6
3.	STORE (F1) stores the codelist and returns to MANAGE Codelists .	

10.5

10.5.1

Managing Codes

Accessing MANAGE Codes

Description

Managing codes includes

- creating new codes
 - viewing codes with their related information
 - editing codes.
 - deleting existing codes.
-

Access step-by-step

Step	Description
1.	Refer to "10.3 Accessing Codelist Management" to access MANAGE Codelists .
2.	In MANAGE Codelists highlight the codelist of which codes are to be managed.
3.	EDIT (F3) to access MANAGE Edit Codelist .
4.	CODES (F4) to access MANAGE Codes . This screen is described below.

MANAGE Codes

Codes from currently active code groups are shown.

The listed code groups belong to

the selected System RAM codelist when this screen was accessed through **Main Menu: Manage...\Codelists**.

OR

to the job codelist when **MANAGE Codes** was accessed from an application program, **MANAGE New Job** or **MANAGE Edit Job**.

The  indicates codes which have attributes attached.

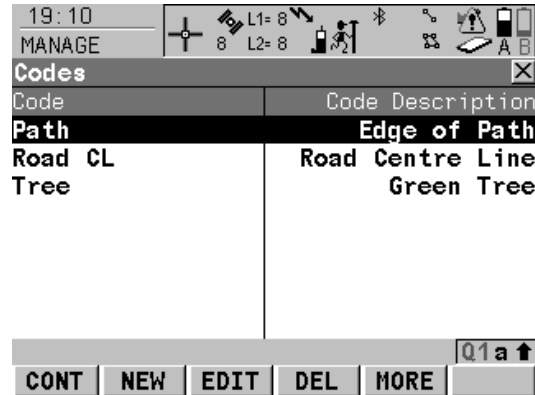

CONT (F1)

To close the screen and return to the screen from where this screen was accessed.

NEW (F2)

To create a new code. Refer to "10.5.2 Creating a New Code".

EDIT (F3)

To edit the highlighted code. Refer to "10.5.3 Editing a Code".

DEL (F4)

To delete the highlighted code.

MORE (F5)

To display information about the code description, the quick codes if available, the code groups and the code type.

SHIFT GROUP (F4)

To view, create, delete, activate and deactivate code groups. Refer to "10.6 Managing Code Groups".

SHIFT SORT (F5)

To sort codes by code name, code description, quick code or the last use.

Next step

IF	THEN
a code is to be created	NEW (F2) . Refer to "10.5.2 Creating a New Code".
a code is to be edited	highlight the code and EDIT (F3) . Refer to "10.5.3 Editing a Code".
code groups are to be accessed	SHIFT GROUP (F4) . Refer to "10.6 Managing Code Groups".



10.5.2



Creating a New Code

Create a new code step-by-step

The following table explains the most common settings. Refer to the stated chapter for more information on screens.

Step	Description	Refer to chapter
1.	Refer to "10.5.1 Accessing MANAGE Codes" to access MANAGE Codes .	
2.	NEW (F2) to access MANAGE New Code .	
3.	<p>MANAGE New Code</p> <p><Code:> A unique name for the new code. The name may be up to 16 characters long and may include spaces. Input required.</p> <p><Code Desc:> A detailed description of the code. This can be for example the full designation if <Code:> is an abbreviation. Input optional.</p> <p><Group:> The code group to which the code is to be assigned. All code groups from MANAGE Code Groups can be selected.</p> <p><Code Type:> Defines the use of the code. It can be used as thematic code for points, lines or areas or as a free code.</p> <p><Linework:> Only available for <Code Type: Point>. This field contains a choicelist, to allow a new line or new area to be opened whenever the point code is newly selected. This functionality is also available when creating codelists with LGO Codelist Management.</p>	<p>10.1</p> <p>10.1</p>

Step	Description	Refer to chapter
	<ul style="list-style-type: none"> • None: Select this option to disable the functionality. All other code settings on the instrument are not affected when this option is set. • Begin Line: When a point code is newly selected, a new line is opened and the point being stored is added to the line. When the same point code remains selected, a new line is not opened. The point being stored is simply added to the current line. • Begin Area: The behaviour for opening a new area is the same as the behaviour for opening a new line, as mentioned above. 	
	<p><Line Style:> Not available for <Code Type: Free>. The style in which lines/areas are represented in MapView and LGO.</p>	
	<p><Code Type:> makes a code unique. <Code:> can be the same value with different <Code Type:> within the same codelist. For example <Code: Oak> can have <Code Type: Point>, <Code Type: Line>, <Code Type: Area> and/or <Code Type: Free>.</p>	
4.	<p>NEW-A (F2) adds <Attribute 1:> as new input field for an attribute of attribute type normal and of value type text.</p>	
	<p>NAME (F3) or VALUE (F3) Available for attributes for which an attribute name can be typed in. To highlight <Attribute 1:> or the field for the attribute value. The name of <Attribute 1:> can be edited and the attribute value to be used as the default attribute value can be typed in.</p>	
	<p>Attributes of attribute type mandatory or fixed and of value type real or integer must be created in LGO.</p>	

Step	Description	Refer to chapter
	Up to twenty attributes can be created.	
5.	Is another attribute to be created? <ul style="list-style-type: none">• If yes, repeat step 4.• If no, continue with step 6.	
6.	STORE (F1) adds the new code and any associated attributes to the System RAM codelist and returns to the screen from where this screen was accessed.	
	A new code can also be created within an application program. In this case, the new code is added to the job codelist.	

10.5.3

Editing a Code

Access step-by-step

Step	Description
1.	Refer to "10.5.1 Accessing MANAGE Codes" to access MANAGE Codes .
2.	EDIT (F3) to access MANAGE Edit Code .
3.	All following steps are identical with the creation of a new code. Refer to "10.5.2 Creating a New Code". Follow the instructions in paragraph "Create a new code step-by-step" from step 3. onwards.
	Attribute names that have already been typed in cannot be edited in a job codelist.

10.6

Managing Code Groups

Access step-by-step

Step	Description
1.	Refer to "10.5.1 Accessing MANAGE Codes" to access MANAGE Codes .
2.	SHIFT GROUP (F4) to access MANAGE Code Groups .

**MANAGE
Code Groups**

The listed code groups belong to
the selected System RAM codelist when this screen was accessed through **Main Menu:
Manage...\Codelists**.

OR

to the job codelist when **MANAGE Codes** was accessed from an application program,
MANAGE New Job or **MANAGE Edit Job**.

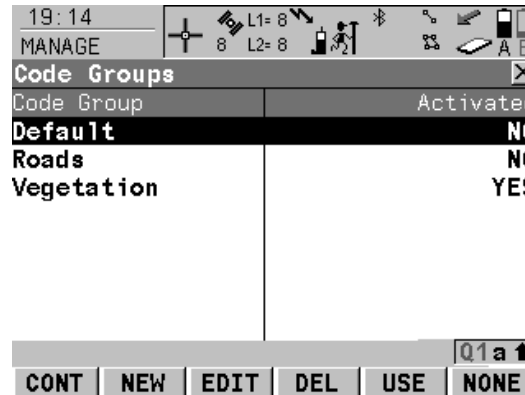
**CONT (F1)**

To close the screen and return to the screen from where this screen was accessed.

NEW (F2)

To create a new code group.

EDIT (F3)

Available for System RAM codelists. To edit the highlighted code group.

DEL (F4)

Available for System RAM codelists. To delete the highlighted code group.

USE (F5)

To activate and deactivate the highlighted code group. Codes belonging to a deactivated code group are not displayed in **MANAGE Codes**.

NONE (F6) or ALL (F6)

To deactivate or activate all code groups.

Description of columns

Column	Description
Code Group	The name of the code group.
Activated	Use code group or not. The options are Yes and No . The codes belonging to a deactivated code group cannot be selected from the choicelist for code selection. USE (F2) changes between the options.

Next step

IF a code group	THEN
is to be created	NEW (F2) . In MANAGE New Code Group type in a unique name for <Group:> . STORE (F1) stores the new code group typed in and returns to MANAGE Code Groups .
is to be edited	highlight the code group and EDIT (F3) . In MANAGE Edit Code Group type in the changes for <Group:> . STORE (F1) stores the changes and returns to MANAGE Code Groups .

11

Coding

11.1

Overview

Description

A code is a description which can be stored with a point, line, area or alone. Coding on GPS1200 is very flexible with thematical, free and quick coding being available. Thematical and free coding is possible by selecting codes from a codelist or by directly typing in codes. SmartCodes are a quick way for a code to be stored with a point to be selected and to be measured.



For coding, points, lines and areas have the same behaviour. In this chapter, the word object is used as a generic term for points, lines and areas.

Coding methods

Coding method	Characteristic	Description
Thematical	<p>Use</p> <p>Selection of the codes</p>	<p>To store a description together with an object inside an application program or in Main Menu: Manage...\Data.</p> <ul style="list-style-type: none"> For thematical coding with codelist: On a configured display mask, codes are selected from the job codelist in a choicelist. The job codelist must contain thematical codes. For thematical coding without codelist: On a configured display mask, codes are manually typed in.

Coding method	Characteristic	Description
	Recording of the codes	Together with the objects.
Free	Use Selection of the codes Recording of the codes	To store a description independent of an object at any time. A free code can be used to store a description related to an object or to store additional descriptions such as the job name or the temperature. <ul style="list-style-type: none"> • For free coding using a codelist: Pressing the configured hot key opens a choicelist with the free codes of the job codelist. • For free coding with direct input: Pressing the configured hot key opens a screen for alphanumeric input. Stored as time related information. A time stamp is stored with each free code. According to the requirements of the CAD package used, free codes can be configured to be stored before or after the object.
Quick	Use	Quick coding is the storing of an object plus a thematical or free code using a minimum number of keystrokes.

Coding method	Characteristic	Description
	<p data-bbox="608 206 868 230">Selection of the codes</p> <p data-bbox="608 376 805 432">Recording of the codes</p> 	<p data-bbox="884 206 1493 359">Shortcuts must be assigned to codes in the job codelist. <Quick Code: On> must be set in CONFIGURE Coding & Linework. Typing the shortcut searches for the assigned code. Point occupation begins.</p> <ul data-bbox="884 376 1493 633" style="list-style-type: none"> • For thematical codes: Together with the objects. With <Auto STOP: Yes> and <Auto STORE: Yes>, the points and codes are immediately stored. • For free codes: Stored as time related information before or after the points. A time stamp is stored with each free code. <p data-bbox="884 652 1332 677">Quick codes must be created in LGO.</p> <p data-bbox="884 697 1493 722">Characters that can be assigned to quick codes are:</p> <ul data-bbox="884 731 1225 829" style="list-style-type: none"> • 0 to 9 • A to Z, not case sensitive • a to z, not case sensitive

Configure coding

Refer to "19.3 Coding & Linework" for information on configuring coding.

11.2

11.2.1

Thematical Coding

Thematical Coding with Codelist

Requirements

- The job codelist contains thematical codes for points, lines and/or areas.
 - **<Thematc Codes: With Codelist>** in **CONFIGURE Coding & Linework**.
 - A display mask with an input field for codes must be configured.
-

Access

Open the choicelist for **<Code:>** in a display mask of an application program.

OR

Open the choicelist for a **<Code:>/<Point Code:>** in **MANAGE New Point, Code** page in data management. The procedure is similar for lines and areas.

OR

Open the choicelist for **<Point Code:>** in **MANAGE Edit Point: Point ID, Code** page in data management. The procedure is similar for lines and areas.

OR

Open the choicelist for **<Code (Auto):>** in **SURVEY Survey: Job Name, Auto** page, if configured.

MANAGE Select Code

MANAGE Select Code is shown as an example.

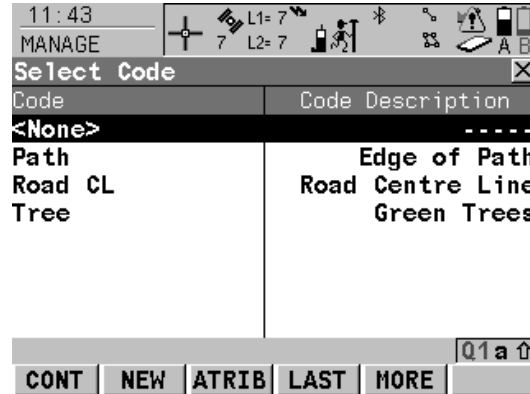

CONT (F1)

To return to the screen from where this screen was accessed.

NEW (F2)

To create a new code. Refer to "10.5.2 Creating a New Code".

ATRIB (F3)

Available unless accessed from **MANAGE New Point/Line/Area** or **MANAGE Edit Point/Line/Area**. To type in attribute values for the selected code and/or add new attributes for the selected code.

LAST (F4)

Available if a code has been previously used in the active job. To select from a list of last used codes. The codes are sorted by time with the most recently used code at the top of the list.

MORE (F5)

To display information about the code description, the code group, the code type and the quick code if codes with quick codes exist in the job.

SHIFT GROUP (F4)



To view, create, delete, activate and deactivate code groups. Refer to "10.6 Managing Code Groups".







SHIFT SORT (F5)

To sort codes by code name, code description, quick code or the last used.

Thematical coding with codelist step-by-step

The following table explains the most common settings. Refer to the stated chapter for more information on screens.

Step	Description	Refer to chapter
1.	Refer to paragraph "Access" to access XX Select Code .	
2.	MANAGE Select Code Depending on the setting for <Show Codes:> in CONFIGURE Coding & Linework , either all point, line and area codes or only all point codes from the job codelist which belong to the active code groups are available for selection. Codes marked with  have attributes attached.	19.3, 10.6
3.	Highlight the desired code.	
	<ul style="list-style-type: none"> • If a point code is selected then any open line/area is closed. The occupied point is stored with the selected code independently of any line/area. • If a line code is selected then any open line is closed and a new line with the selected code is created. The line ID is defined by the configured line ID template. The occupied point is assigned to that line. The line stays open until it is closed manually or another line code is selected. • If an area code is selected then the behaviour is as for lines. 	
4.	ATTRIB (F3)	
5.	XX Enter Attributes	

Step	Description	Refer to chapter
	<p>If configured for the selected code, input fields for attribute values are available. Type in the attribute values. Attribute values for attributes of type</p> <ul style="list-style-type: none"> • normal can be typed in. • fixed cannot be edited. 	
	NEW-A (F2) to add a new attribute of type normal and of value type text.	
	NAME (F3) or VALUE (F3) Available for attributes for which an attribute name can be typed in. To highlight <Attribute n:> or the field for the attribute value.	
	Attributes of type mandatory or fixed and of value type real or integer must be created in LGO.	online help in LGO.
	Up to twenty attributes can be added.	
	LAST (F4) recalls the last used attribute values for the selected code.	
	DEFLT (F5) recalls the default attribute values for the selected code.	
6.	CONT (F1) returns to the screen from where MANAGE Select Code was accessed.	
	The code and any associated attribute values are stored when the point is stored.	

Step	Description	Refer to chapter
	If a point with the same point ID exists in the job, the codes, the attribute names and the attribute values of the new and the existing point must be identical. Should they not be identical, a screen opens where the code or attribute mismatch can be corrected.	11.6

11.2.2

Thematical Coding without Codelist

Requirements

- **<Themac Code: Without Codelist>** in **CONFIGURE Coding & Linework**.
- A display mask with an input field for codes must be configured.
- A display mask with an choicelist for code types must be configured.

Access

A thematical code is typed in the field

<Code:> in a display mask of an application program.

OR

<Code:>/<Point Code:> in **MANAGE New Point, Code** page in data management. The procedure is similar for lines and areas.

OR



<Point Code:> in **MANAGE Edit Point: Point ID, Code** page in data management. The procedure is similar for lines and areas.

OR

in the field **<Code (Auto):>** in **SURVEY Survey: Job Name, Auto** page, if configured.

**Thematical coding
without codelist step-
by-step**

Step	Description
	Thematical coding in the Survey application program is explained in this step-by-step instruction. A typical configuration set with a display mask for coding called Code is used.
1.	<p>SURVEY Survey: Job Name, Code page</p> <p><Point ID:> The identifier for the point.</p> <p><Code Type:> Select if a point, line or area code will be used.</p>

Step	Description
	<p><Code:> The name for the point, line or area code.</p> <p><Attribute n:> The attribute values for the code.</p> <p>Type in a code and attribute values.</p>
	Up to eight attributes can be added. This is configured in the display mask.
	<ul style="list-style-type: none"> • If a point code is selected then any open line/area is closed. The occupied point is stored with the selected code independently of any line/area. • If a line code is selected then any open line is closed and a new line with the selected code is created. The line ID is defined by the configured line ID template. The occupied point is assigned to that line. The line stays open until it is closed manually or another line code is selected. • If an area code is selected then the behaviour is as for lines.
2.	<p>OCUPY (F1) to start the point occupation.</p> <p>OR</p> <p>PAGE (F6) to change to another page on this screen.</p>

11.3 Free Coding

11.3.1 Free Coding Using a Codelist



In this chapter, free coding using a codelist is explained for points. Refer to "9.4 Line/Area Management" for information on coding lines/areas.

Requirements

- The job codelist contains free codes.
 - A hot key is configured to access the screen **FREECODE Select Free Code** or the user defined menu is configured to display the option **Select Free Code**.
-

Access

Press a hot key configured to access the screen **FREECODE Select Free Code**. Refer to "6.1 Hot Keys" for information on hot keys.

OR

Press **USER** and select **Select Free Code** to access the screen **FREECODE Select Free Code**. Refer to "6.2 USER Key" for information on the **USER** key.

FREECODE

Select Free Code

Code	Code Description
Path	Edge of Path
Road CL	Road Centre Line
Tree	Green Trees

Q1 a ↑

STORE NEW ATRIB MORE

STORE (F1)

To store the free code and any associated attribute values and to return to the screen from where this screen was accessed.

NEW (F2)

To create a new code. Refer to "10.5.2 Creating a New Code".

ATRIB (F3)

To type in attribute values and/or add new attributes for the selected free code.

LAST (F4)

Available if a free code has been previously used in the active job. To select from a list of last used free codes. The free codes are sorted by time with the most recently used code at the top of the list.

MORE (F5)

To display information about the code description, the code group and the quick code if codes with quick codes exist in the job.

SHIFT GROUP (F4)



To view, create, delete, activate and deactivate code groups. Refer to "10.6 Managing Code Groups".





SHIFT SORT (F5)

To sort codes by code name, code description, quick code or the last used.

Free coding using a codelist step-by-step

The following table explains the most common settings. Refer to the stated chapter for more information on screens.

Step	Description	Refer to chapter
1.	Refer to paragraph "Access" to access FREECODE Select Free Code .	
2.	FREECODE Select Free Code All free codes from the job codelist which belong to the active code groups are available for selection. Free codes marked with  have attributes attached.	10.6
3.	Highlight the desired code.	
4.	ATRIB (F3) to access FREECODE Enter Attributes .	
5.	FREECODE Enter Attributes <Free Code:> The name of the selected code for which attribute values are to be typed in. <Code Desc:> The detailed description of the selected code. If configured for the selected code, input fields for attribute values are available. Type in the attribute values. Attribute values for attributes of type <ul style="list-style-type: none"> • normal can be typed in. • fixed cannot be edited. 	
	NEW-A (F2) to add a new attribute of type normal and of value type text.	

Step	Description	Refer to chapter
	NAME (F3) or VALUE (F3) Available for attributes for which an attribute name can be typed in. To highlight <Attribute n:> or the field for the attribute value.	
	Attributes of type mandatory or fixed and of value type real or integer must be created in LGO.	online help in LGO.
	Up to twenty attributes can be added.	
	LAST (F4) recalls the last used attribute values for the selected code.	
	DEFLT (F5) recalls the default attribute values for the selected code.	
6.	FREECODE Enter Attributes STORE (F1) returns to the screen from where FREECODE Select Free Code was accessed and stores the free code, any associated attribute values and time related information.	

11.3.2

Free Coding with Direct Input



In this chapter, free coding with direct input is explained for points. Refer to "9.4 Line/Area Management" for information on coding lines/areas.

Requirements

A hot key is configured to access the screen **FREECODE Enter Free Code & Attributes** or the user defined menu is configured to display the option **Enter Free Code**.

Access

Press a hot key configured to access the screen **FREECODE Enter Free Code & Attributes**. Refer to "6.1 Hot Keys" for information on hot keys.

OR

Press **USER** and select **Enter Free Code** to access the screen **FREECODE Enter Free Code & Attributes**. Refer to "6.2 USER Key" for information on the **USER** key.

Free coding with direct input step-by-step

Step	Description
1.	Refer to paragraph "Access" to access FREECODE Enter Free Code & Attributes .
2.	FREECODE Enter Free Code & Attributes <Free Code:> The name for the free code. <Attribute n:> The attribute values for the free code. Type in a code and attribute values.
	As soon as a free code is typed in, a codelist is created within the job.
	Up to eight attributes can be added.
	LAST (F4)

Step	Description
	<p>Available if a free code has been previously used in the active job. Accesses FREECODE Last Used Free Codes. To select from a list of last used free codes. The free codes are sorted by time with the most recently used code at the top of the list.</p> <p>In FREECODE Last Used Free Codes press ATRIB (F3) to type in attribute values.</p>
3.	STORE (F1) stores the free code, any associated attribute values and time related information.

11.4

Quick Coding

Requirements

- The job codelist contains quick codes for points, lines and/or areas.
 - According to the requirements of the used CAD package, set **<Rec Free Code: Before Point>** or **<Rec Free Code: After Point>** in **CONFIGURE Coding & Linework**.
-





Activate quick coding





The current setting for **<Quick Code:>** in **CONFIGURE Coding & Linework** determines how quick coding is activated. Quick coding can be activated at any time.

- For **<Quick Code: On>** in **CONFIGURE Coding & Linework**
Quick coding is active and can be used.
 - For **<Quick Code: Off>** in **CONFIGURE Coding & Linework**
Press a hot key configured to switch between **<Quick Code: Off>** and **<Quick Code: On>** in **CONFIGURE Coding & Linework**. Refer to "6.1 Hot Keys" for information on hot keys.
OR
Press **USER**. Refer to "6.2 USER Key" for information on the **USER** key.
OR
Tap the quick coding icon.
OR
Access **CONFIGURE Coding & Linework** and change the setting manually. Refer to "19.3 Coding & Linework".
 - For **<Quick Code: Never>** in **CONFIGURE Coding & Linework**
Access **CONFIGURE Coding & Linework** and change the setting manually. Refer to "19.3 Coding & Linework".
-

Quick coding for points step-by-step

The following table explains the most common settings. Refer to the stated chapter for more information on screens.





Step	Description	Refer to chapter
1.	Refer to paragraph "Activate quick coding" to activate quick coding.	
	A screen must be active where points can be occupied. OCUPY (F1) must be visible. For example SURVEY Survey: Job Name .	
2.	Type in the one, two or three digits of the quick code. The current setting for <Digits:> in CONFIGURE Coding & Linework determines by how many keystrokes quick coding is executed.	19.3
	ENTER to execute quick coding already after one or two keystrokes. Available for <Digits: 2> and <Digits: 3> in CONFIGURE Coding & Linework .	
	ESC clears digits from the entry.	
3.	What is the code type of the quick codes? <ul style="list-style-type: none"> • For point codes continue with the next row. • For free codes continue with step 5. 	
	The point code assigned to the quick code is searched for in the job codelist and point occupation begins.	
	Attribute values for attributes of type <ul style="list-style-type: none"> • normal cannot be typed in. Depending on the setting for <Attributes:> in CONFIGURE Coding & Linework, the default or the last used attribute values are stored. 	

Step	Description	Refer to chapter
	<ul style="list-style-type: none"> fixed cannot be edited. 	
	The point code and any associated attribute values are stored with the point. This can be automatic if <Auto STOP: Yes> and <Auto STORE: Yes> is configured or manual with STOP (F1) and STORE (F1) .	
	If a point with the same point ID exists in the job, the codes, the attribute names and the attribute values of the new and the existing point must be identical. Should they not be identical, a screen opens where the code or attribute mismatch can be corrected.	11.6
4.	Quick coding for a point code is finished.	
5.	Quick coding for free codes continues from here.	
	The free code assigned to the quick code is searched for in the job codelist and point occupation begins.	
	Attribute values for attributes of type <ul style="list-style-type: none"> normal cannot be typed in. Depending on the setting for <Attributes:> in CONFIGURE Coding & Linework, the default or the last used attribute values are stored. fixed cannot be edited. 	
	The free code, associated attribute values and time related information are stored. The setting for <Rec Free Code:> in CONFIGURE Coding & Linework determines if the free code is stored before or after the point.	

Step	Description	Refer to chapter
6.	Quick coding for a free code is finished.	

Quick coding for lines/areas step-by-step

The following table explains the most common settings. Refer to the stated chapter for more information on screens.

Step	Description	Refer to chapter
1.	Refer to paragraph "Activate quick coding" to activate quick coding.	
2.	Type in the one, two or three digits of the quick code. The current setting for <Digits:> in CONFIGURE Coding & Linework determines by how many keystrokes quick coding is executed.	19.3
	ENTER to execute quick coding already after one or two keystrokes. Available for <Digits: 2> and <Digits: 3> in CONFIGURE Coding & Linework .	
	ESC clears digits from the entry.	
	The line/area code assigned to the quick code is searched for in the job codelist.	
	A new line/area is created and immediately stored with that line/area code and attributes. For the line/area ID, the line/area ID template as defined in CONFIGURE ID Templates is used.	
	The system asks for mandatory attribute values.	
3.	Quick coding for a line/area is finished.	

11.5

SmartCodes

11.5.1

Overview

Description

SmartCodes is basically a quick way for code to be selected and point to be measured. All existing coding, linework, and point measurement functionality is retained.

11.5.2

Configuring SmartCodes

Access

Select **Main Menu: Survey**. In **SURVEY Survey Begin** press **CONF (F2)** to access **SURVEY Configuration**.

OR

In **SURVEY Survey: Job Name** press **SHIFT CONF (F2)** to access **SURVEY Configuration**.

SURVEY Configuration, SCode page

The settings on this page activate the using of SmartCodes and define the method. All settings in this panel are stored within the currently active configuration set.

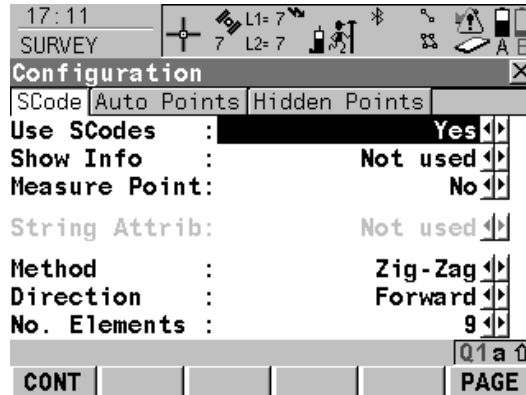



CONT (F1)



To accept changes and return to the screen from where this screen was accessed.

PAGE (F6)

To change to another page on this screen.

Description of fields

Field	Option	Description
<Use SCodes:>	Yes	Activates using of SmartCodes.  All other fields on the screen are active and can be edited.
	No	Deactivates using of SmartCodes and all fields on this screen.
<Show Info:>	Not used	Information shown in line 8 of SURVEY Survey: Job name, SCode page. No display mask element is shown.
	Point ID	The identifier for manually occupied points. The configured point ID template is used.  Refer to "44.3 Surveying Points".
	3D CQ	The current 3D coordinate quality of the computed position.
	2D CQ	The current 2D coordinate quality of the computed position.
	1D CQ	The current height coordinate quality of the computed position.
	Antenna Ht	The height of the antenna that is being used. Changing the antenna height here does not update the default antenna height as defined in the active configuration set.

Field	Option	Description
<Measure Point:>	Yes or No	If one of the code boxes is tapped in SURVEY Survey: Job name, SCode page then that code is selected and the point is measured for <Measure Point:Yes>.
<String Attrib:>	Choicelist	Available for <Show Codes: All Codes>. When this field is active, surveyed points that have the same code attached are strung to one line.  Refer to "19.3 Coding & Linework".
<Method:>	<p>Not used</p> <p>Zig-Zag</p> <p>Same direction</p> 	<p>Method by which subsequent code box is selected after a point is stored.</p> <p><Direction:> and <No. Elements:> are invisible and the number of codes boxes shown in SURVEY Survey: Job name, SCode page is nine.</p> <p>Each new code block is started at the same end as where the previous code block finished.</p> <p>Each new code block is started at the same end as where the previous code block started.</p> <p>Refer to "47.1 Overview" for <Method: Zig-Zag> or <Method: Same direction>.</p>
<Direction:>	Forward	<p>The way of using the code boxes. This influences in which order the code boxes will be applied.</p> <p>The code boxes are used in the same way as defined in SURVEY Survey: Job name, SCode page.</p>

Field	Option	Description
	Backward	The code boxes are used in the reverse way as defined in SURVEY Survey: Job name, SCode page.
<No. Elements:>	1, 2, 3, 4, 5, 6, 7, 8 or 9	Number of code boxes shown in SURVEY Survey: Job name, SCode page.

11.5.3

Code Block

Requirements

- <Use SCodes: Yes> in SURVEY Configuration, SCode page.

SURVEY

Survey: Job Name,
SCode page

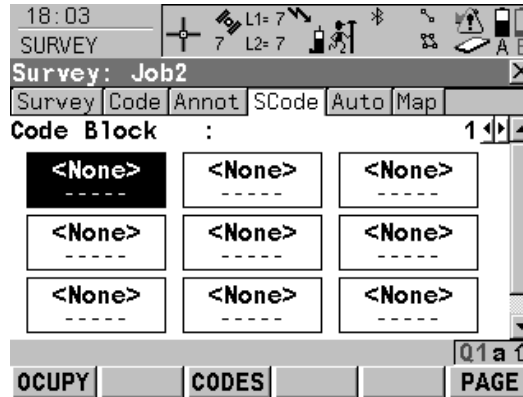

OCUPY (F1)

To start recording positions. The position mode icon changes to the static icon. (F1) changes to **STOP**. The highlighted code is stored with the point.

CODES (F3)

To select a code from **MANAGE Select Code** panel.

PAGE (F6)

To change to another page on this screen.

Creating a Code Block step-by-step

The following table explains the most common settings. Refer to the stated chapter for more information on screens.

Step	Description	Refer to chapter
1.	Refer to paragraph "Accessing Survey" to access SURVEY Survey Begin .	44.1
2.	CONT (F1) to access SURVEY Survey: Job Name .	

Step	Description	Refer to chapter
3.	PAGE (F6) until the SCode page is visible.	
4.	With the focus on <Code Block: 1> press enter to access SURVEY Manage Code Blocks panel.	
5.	NEW (F2) to create a new code block.	
	Code blocks can only be created or deleted in SURVEY Manage Code Blocks panel.	
6.	CONT (F1) to return to SURVEY Survey: Job Name, SCode page.	







Assigning codes to a Code Block step-by-step

The following table explains the most common settings. Refer to the stated chapter for more information on screens.

Step	Description	Refer to chapter
1.	Refer to paragraph "Creating a Code Block step-by-step" to access SURVEY Survey: Job Name, SCode page.	
2.	Move the focus on a code box.	
3.	CODES (F4) to select a code to be assigned to the highlighted code block.	
	To create a new code to be assigned refer to "Creating a New Code".	10.5.2

Copying a Code Block to a new job step-by-step

The following table explains the most common settings. Refer to the stated chapter for more information on screens.





Step	Description	Refer to chapter
	Code blocks are stored in the job.	
1.	Refer to paragraph "Accessing Job Management" to access MANAGE Edit Job: Job Name, Codelist page.	8.2
	<Codelist:> If codes had been copied from a System RAM codelist, the name of the codelist is displayed. If codes have been typed in, then the name of the active job is displayed.	
2.	SHIFT EXPRT (F2) copies codes and code blocks from the job to an existing or new codelist.	
	To create a new codelist refer to "Creating/Editing a Codelist".	10.4
	Copying code blocks to an existing codelist overwrites the code blocks of the existing codelist.	
3.	STORE (F1) to save the currently active job and return to MANAGE Job (Device) .	
4.	Create a new job and assign the related codelist to the job.	
	SmartCodes from the codelist are now available within the new job.	
	To create a new job refer to "Creating a New Job".	8.3

11.5.4

Using SmartCodes

Measuring points using Code Blocks step-by-step

The following table explains the most common settings. Refer to the stated chapter for more information on screens.

Step	Description	Refer to chapter
1.	Refer to paragraph "Creating a Code Block step-by-step" to access SURVEY Survey: Job Name, SCode page.	11.5.3
2.	Move the focus on a code box.	
	When <String Attrib:> is active, you can type in an attribute value below the code name of the highlighted code box.	
	+ (F4) or - (F5) to increase or decrease the value. Applies only if the value is numeric.	
3.	OCUPY (F1)	
	For <Measure Point: Yes> in SURVEY Survey: Job name, SCode page, tapping the code box with the supplied stylus automatically starts measuring the point. Selecting the code box by using the arrow keys will not start measuring the point.	
4.	STOP (F1)	
5.	STORE (F1)	
	The point is stored with the code assigned to the highlighted code box.	

11.6

11.6.1

Code and Attribute Mismatch

Code Mismatch

Description

When storing a point with a code, it may happen that a point with the same point ID already exists in the job. If the codes of the new and the existing point do not match, a screen opens where the code can be corrected. One point cannot have different codes.

XX

Point Code Mismatch

11:39 SURVEY L1= 8 L2= 8

Point Code Mismatch

Point ID : 100

New Code : **Tree**

Code Desc : Green Trees

Stored Code : Path

Code Desc : Edge of Path

Code mismatch - choose code Q1 a ↑

STORE MORE

STORE (F1)

To store the highlighted code and any associated attributes with the point being stored and to continue with the application program or data management.

MORE (F5)

To display information about the code description, the code group and any attributes associated with the highlighted code.

Description of fields

Field	Option	Description
<New Code:>	Output	The code for the point.
<Stored Code:>	Output	The code as stored for the existing point in the job.

Match codes step-by-step

Step	Description
	XX Point Code Mismatch opens automatically if the codes of the new and the existing point do not match.
1.	Highlight the code to be stored with the new point.
2.	STORE (F1) stores the highlighted code and any associated attributes with the point being stored and continues with the application program or data management.

11.6.2

Attribute Mismatch

Description

If a point with the same point ID exists in the job, the codes, the attribute names and the attribute values of the new and the existing point must be identical. Should they not be identical, a screen opens where the attribute mismatch can be corrected. One point cannot have different attributes.



The name of the screen changes with pressing **CURNT (F5)** or **STORD (F5)**:

Pressing **CURNT (F5)**: **XX Attributes Being Stored**

Pressing **STORD (F5)**: **XX Attributes Already Stored**

For simplicity, the screen shown is **XX Attributes Already Stored**.

XX Attributes Already Stored

Point ID	:	100
Point Code	:	Tree
Code Desc	:	Green Trees
Species	:	Oak
Height	:	2.500
Condition	:	Dead

STORE (F1)

To store the selected attributes with the new/created point and to continue with the application program or data management.

CURNT (F5) or STORD (F5)

To change between viewing the attribute names and values of the new/created point and those stored for the existing point in the job.

Choose attribute values Q1 a ↑

STORE CURNT

Description of fields

Field	Option	Description
<Point Code:>	Output	<ul style="list-style-type: none"> For XX Attributes Already Stored: The code of the existing point in the job. For XX Attributes Being Stored: The code of the new point.
Attributes	Output	<ul style="list-style-type: none"> For XX Attributes Already Stored: The attributes as stored for the existing point in the job. For XX Attributes Being Stored: The attributes of the new point.

Match attributes step-by-step

Step	Description
	XX Attributes Already Stored opens automatically if the attribute names and/or values of the new and the existing point do not match.
1.	CURNT (F5) and STORD (F5) to display the attribute names and values to be stored with the point.
2.	STORE (F1) stores the displayed attribute names and values with the point being stored and continues with the application program or data management.

12

Linework

12.1

Overview

Description

Working with lines can be automated. Two ways of working are available. They are listed in the table below. The two ways of working can be mixed.

Linework by	Description
Linework listbox	<p>In all application programs and on the Auto page in Survey, a display mask can be configured to show a field <Linework:> with a choicelist.</p> <p>The selection from the choicelist determines</p> <ul style="list-style-type: none"> • the action taken for a line/area, for example opening or closing a line. • the flag stored with a point. <p>The flags</p> <ul style="list-style-type: none"> • are configured in CONFIGURE Coding & Linework, Linework page. • can be exported with a format file.
Coding	<p>Line/area codes can be selected in many application programs.</p> <p>Selecting a line/area code closes any open lines/area and opens a new line/area.</p> <p>Refer to "11 Coding" for more information.</p>



The Linework flag and coding are not linked.

Additionally to Linework, thematical point, line and area codes can be used.

Quick coding can be used as per normal.

12.2



Requirements

Performing Linework

The Survey application program is used here to explain Linework.

- A display mask with a choicelist for Linework must be configured.
- The flags for Linework must be defined in **CONFIGURE Coding & Linework Settings, Linework** page.
- **<R-Time Mode: None>** or **<R-Time Mode: Rover>** in **CONFIGURE Real-Time Mode**.

Access step-by-step

Step	Description
1.	Select Main Menu: Survey to access SURVEY Survey Begin .
2.	In SURVEY Survey Begin select a job.
3.	Select a configuration set with <R-Time Mode: None> or <R-Time Mode: Rover> .
4.	Select an antenna.
5.	CONT (F1) to access SURVEY Survey: Job Name .

SURVEY

**Survey: Job Name,
Survey page**

The most important keys are explained. For the explanation of the other keys refer to "44.3.3 Real-Time Rover Operations".

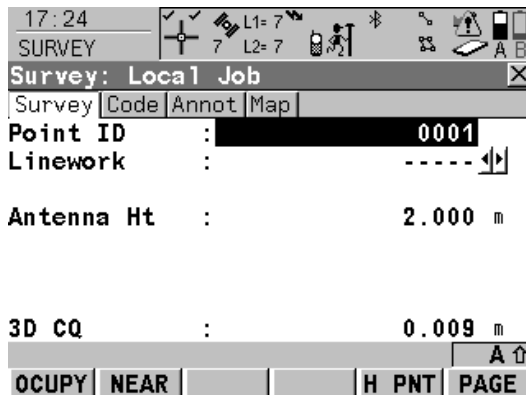

OCUPY (F1)

To start recording positions. The position mode icon changes to the static icon. **(F1)** changes to **STOP**.

STOP (F1)

To end recording of positions when enough data is collected. When **<Auto STOP: Yes>** in **CONFIGURE Point Occupation Settings**, recording of positions ends automatically as defined by the stop criteria. The position mode icon changes to the moving icon. **(F1)** changes to **STORE**.

STORE (F1)

To store the point information. When **<Auto STORE: Yes>** in **CONFIGURE Point Occupation Settings**, the measured point is stored automatically. **(F1)** changes to **OCUPY**.

Description of fields

Field	Option	Description
<Point ID:>	User input	The identifier for manually occupied points. The configured point ID template is used. The ID can be changed in the following ways:

Field	Option	Description
		<ul style="list-style-type: none"> • To start a new sequence of point ID's type over the point ID. • For an individual point ID independent of the ID template SHIFT INDIV (F5). SHIFT RUN (F5) changes back to the next ID from the configured ID template. Refer to "19.1 ID Templates".
<Linework:>	<p>-----</p> <p>Begin Line</p> <p>3pt Curve</p> <p>ReOpen Any Line</p>	<p>The linework flag to be stored with the point. The options available depend on whether a line/area is currently open.</p> <p>No linework flag is stored.</p> <p>Opens a new line when the next point is stored. Any line/area which is currently open is closed and the last point belonging to that line/area is given the End Line/Close Area linework flag. The point may or may not be stored with a point code.</p> <p>Stores the linework flag for a curve through the next three measured points and continues a line/area.</p> <p>Opens a line from a list of all lines which are currently stored in the job when the next point is stored. The last code used with the reopened line is automatically selected when the point is stored.</p> <p>Any line/area which is currently open is closed and the last point belonging to that line/area is given the End Line/Close Area linework flag.</p>

Field	Option	Description
	ReOpen Last Line	Opens the last used line again. The last code used with the reopened line is automatically selected when the point is stored.
	End Line	Closes all open lines.
	Cont Line/Area	Indicates a line/area is open.
	Start Spline	Stores the linework flag for beginning a spline and continues any open line/area.
	End Spline	Closes a spline and continues any open line/area.
	Cont Spline	Indicates a line/area is open with spline line type.
	Begin Area	Opens a new area when the next point is stored. Any line/area which is currently open is closed and the last point belonging to that line/area is given the End Line/Close Area linework flag. The point may or may not be stored with a point code.
	ReOpen Any Area	Opens an area from a list of all lines which are currently stored in the job when the next point is stored. The last code used with the reopened area is automatically selected when the point is stored. Any line/area which is currently open is closed and the last point belonging to that line/area is given the End Line/Close Area linework flag.
	ReOpen Last Area	Opens the last used area again. The last code used with the reopened area is automatically selected when the point is stored.

Field	Option	Description
	Close Area	Closes all open areas.

Next step

Step	Description
1.	Go to the point to be occupied.
2.	Select the linework flag to be stored with the next point.
3.	OCUPY (F1)
4.	STOP (F1)
5.	STORE (F1)
	Depending on the option selected for <Linework:> , a line/area is opened, closed or re-opened.
6.	Repeat steps 1. to 5. until all points are occupied.
7.	SHIFT QUIT (F6) to exit the Survey application program.
8.	Use a format file to export the points including the linework flags.

12.3

Combining Linework and Coding

Description

Linework and coding can be combined.

This combination can be useful, because coding, assigning linework flags and opening/closing lines/areas can all be done with one point observation.

Combining Linework and coding can only be configured if thematical point codes or if thematical point, line and area codes are available for selection. Thematical coding can be done with or without codelists.

Configuration options

The configuration for the types of codes available and the configuration for coding with/without a codelist both have an influence on the following:

- The required configuration of a display mask.
- The behaviour of the fields configured for the display mask.
- The behaviour of the software.

The possible configurations and their influence are shown in this table:

Configuration in CONFIGURE Coding & Linework				
<Show Codes:>	Only Pt Codes		All Codes	
<Themac Codes:>	With Codelist	Without Codelist	With Codelist	Without Codelist
Required fields and their appearance in display mask				
<Code:>				
Required	x	x	x	x

Optional Appearance	- Choicelist	- User input	- Choicelist	- User input
<Code Type:>				
Required	-	-	-	x
Optional Appearance	x Output	x Output	x Output	- Choicelist
<Linework:>				
Required	x	x	x	x
Optional Appearance	- Choicelist	- Choicelist	- Choicelist	- Choicelist

Requirements

- A display mask must be configured with
 - a field for codes.
 - a choicelist for Linework.
- The configuration of a field for code types in a display mask is required for working with point, line and area codes without choicelist. Else the configuration of a field for code types is optional.
- Configure in **CONFIGURE Coding & Linework, Coding** page
 - **<Show Codes: Only Pt Codes>** or **<Show Codes: All Codes>**.
 - **<Themac Codes: With Codelist>** or **<Themac Codes: Without Codelist>**.

- In **CONFIGURE Coding & Linework Settings, Linework** page define the flags for Linework.
- **<R-Time Mode: None>** or **<R-Time Mode: Rover>** in **CONFIGURE Real-Time Mode**.



The Survey application program is used here to explain the combination of Linework and Coding.

Access step-by-step

Step	Description
1.	Select Main Menu: Survey to access SURVEY Survey Begin .
2.	In SURVEY Survey Begin select a job.
3.	Select a configuration set with <R-Time Mode: None> or <R-Time Mode: Rover> .
4.	Select an antenna.
5.	CONT (F1) to access SURVEY Survey: Job Name .

SURVEY

**Survey: Job Name,
Survey page**

This is what a display mask configured for Linework and coding looks like.

The most important keys are explained. For the explanation of the other keys refer to "44.3.3 Real-Time Rover Operations".

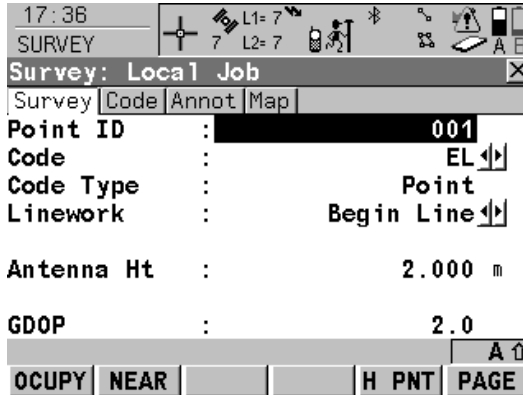

OCUPY (F1)

To start recording positions. The position mode icon changes to the static icon. (F1) changes to **STOP**.

STOP (F1)

To end recording of positions when enough data is collected. When **<Auto STOP: Yes>** in **CONFIGURE Point Occupation Settings**, recording of positions ends automatically as defined by the stop criteria. The position mode icon changes to the moving icon. (F1) changes to **STORE**.

STORE (F1)

To store the point information. When **<Auto STORE: Yes>** in **CONFIGURE Point Occupation Settings**, the measured point is stored automatically. (F1) changes to **OCUPY**.



Linework and Coding step-by-step

For <Show Codes: Only Pt Codes>

Step	Field	Description for thematical coding	
		With codelist	Without codelist
1. 	<Code:>	Select a code from the choicelist. Only point codes are available for selection. <None> to store a point without code or to perform Linework without coding.	Type in a code. ----- to store a point without code or to perform Linework without coding.

Step	Field	Description for thematic coding	
		With codelist	Without codelist
2.	<Code Type:>	Point is displayed. This field is an output field. It can not be changed.	
3.	<Linework:>	<p>Select an option for the Linework flag to be stored with the point. Refer to "12.2 Performing Linework" for a description of the options.</p> <p>Select ----- to store a point without Linework flag or to perform coding without Linework.</p>	
4.	-	OCUPY (F1)	
5.	-	STOP (F1)	
6.	-	STORE (F1)	
	-	<ul style="list-style-type: none"> The point is stored with the selected code. Depending on the selection for <Linework:>, a line/area is opened/closed. An open line/area is closed when the selection for <Linework:> was not changed but <ul style="list-style-type: none"> the selection for <Code:> was changed. the same code was re-selected, for example by using the right/left arrow key. The options available for <Linework:> are updated. 	

For <Show Codes: All Codes>

Step	Field	Description for thematic coding	
		With codelist	Without codelist
1. 	<Code:>	Select a code from the choicelist. Point, line and area codes are available for selection. <None> to store a point without code or to perform Linework without coding.	Type in a code. ----- to store a point without code or to perform Linework without coding.
2.	<Code Type:>	The type of the selected code. This field is an output field. It can not be changed.	Select the type of the entered code.
3. 	<Linework:>	Select an option for the Linework flag to be stored with the point. Refer to "12.2 Performing Linework" for a description of the options. Select ----- to store a point without Linework.	
4.	-	OCUPY (F1)	
5.	-	STOP (F1)	
6.	-	STORE (F1)	
	- -	For a point code being selected: <ul style="list-style-type: none"> The point is stored with the selected code. Depending on the selection for <Linework:>, a line/area is opened/closed. 	

Step	Field	Description for thematical coding	
		With codelist	Without codelist
-		<ul style="list-style-type: none"> An open line/area is closed when the selection for <Linework:> was not changed but <ul style="list-style-type: none"> the selection for <Code:> was changed. the same code was re-selected, for example by using the right/left arrow key. 	
-		<ul style="list-style-type: none"> The options available for <Linework:> are updated. 	
-		<p>For a line/area code being selected:</p> <ul style="list-style-type: none"> The point is stored as part of the line/area. 	
-		<ul style="list-style-type: none"> Depending on the selection for <Linework:>, a line/area is opened/closed. 	
-		<ul style="list-style-type: none"> An open line/area is closed and a new line/area is opened when the selection for <Linework:> was not changed but <ul style="list-style-type: none"> the selection for <Code:> was changed. the same code was re-selected, for example by using the right/left arrow key. 	
-		<ul style="list-style-type: none"> The options available for <Linework:> are updated. 	

13

Manage...\Coordinate Systems

13.1

Overview

Description

A coordinate system

- consists of up to five elements.
- allows the conversion from WGS 1984 geodetic or cartesian coordinates to, local cartesian, geodetic or grid coordinates and back.
- can be attached to jobs.
- can be manually defined.
- can be computed in the field.
- can be downloaded to LGO.
- can be uploaded from LGO.



All GPS surveyed points are always stored as WGS 1984 geodetic coordinates regardless of the coordinate system being used. Using a different coordinate system converts the coordinates displayed on the screen, but does **not** convert and restore the coordinate values in the database DB-X.



One coordinate system can be attached to a job at one time. This coordinate system remains attached to the job unless it is changed.

Elements of coordinate system

The five elements which define a coordinate system are:

- a transformation
- a projection

- an ellipsoid
- a geoid model
- a **Country Specific Coordinate System** model

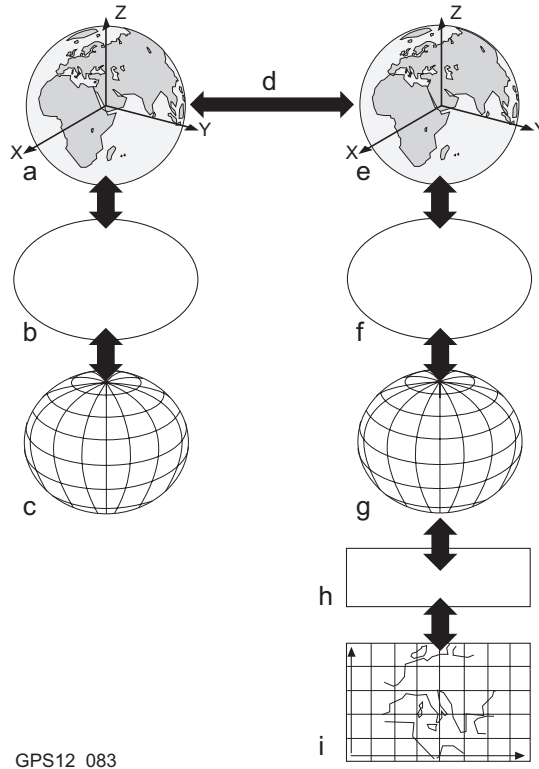

- a) WGS 1984 cartesian: X, Y, Z
- b) WGS 1984 ellipsoid
- c) WGS 1984 geodetic: Latitude, longitude, ellipsoidal height
- d) 7 parameter transformation: dX , dY , dZ , rx , ry , rz , scale
- e) Local cartesian: X, Y, Z
- f) Local ellipsoid
- g) Local geodetic: Latitude, longitude, ellipsoidal height
- h) Local projection
- i) Local grid: Easting, Northing, orthometric height

GPS12_083

All these elements can be specified when creating a coordinate system.

Default coordinate systems

The default coordinate system is **WGS 1984**. It cannot be deleted. Additional default coordinate systems may be available for certain countries.

Coordinate system WGS 1984

WGS 1984 is the global geocentric datum to which all GPS positioning information is referred to. **WGS 1984** is the default coordinate system on a GPS1200 receiver. It is not possible to manually create a coordinate system called **WGS 1984**.

Coordinate system <None>

<None> is the default coordinate system on a TPS1200 instrument. It is not possible to manually create a coordinate system called **<None>**.

Active coordinate system

The active coordinate system is the one attached to the job currently being used. One coordinate system is always considered as the active coordinate system.

Coordinate systems when transferring jobs between GPS and TPS

When transferring a job from GPS1200 to TPS1200, or vice-versa, the coordinate system stays attached to the job and appears like any other coordinate system on the instrument.

13.2

Terminology

Description

This chapter describes technical terms related to coordinate system management.

Transformation

Refer to "38.1 Overview" for information on transformations.

Geoid model

Description

GPS operates on the WGS 1984 ellipsoid and all heights obtained by measuring baselines are ellipsoidal heights. Existing heights are usually orthometric heights, also called height above the geoid, height above mean sea level or levelled height. The mean sea level corresponds to a surface known as the geoid. The relation between ellipsoidal height and orthometric height is

$$\text{Orthometric Height} = \text{Ellipsoidal Height} - \text{Geoid Separation } N$$

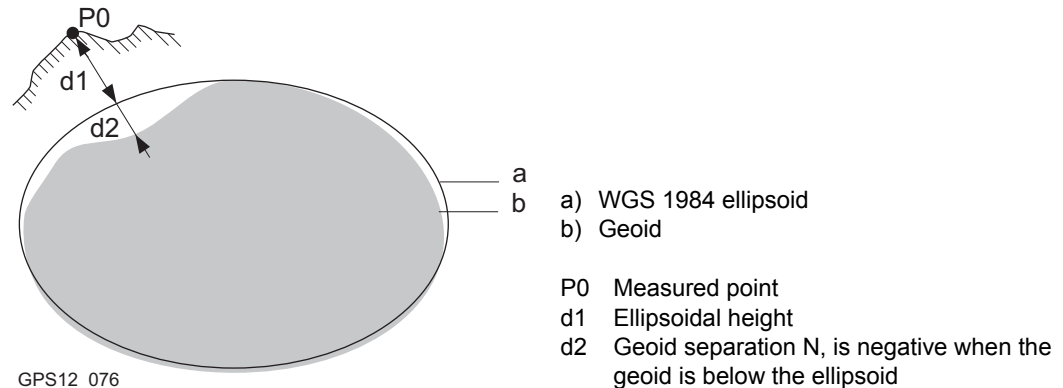

N value and geoid model

The geoid separation (N value) is the distance between the geoid and the reference ellipsoid. It may refer to the WGS 1984 or to the local ellipsoid. It is not a constant except over maybe small flat areas such as 5 km x 5 km. Therefore it is necessary to model the N value in order to obtain accurate orthometric heights. The modelled N values form a geoid model for an area. With a geoid model attached to a coordinate system, N values for the measured points can be determined. Ellipsoidal heights can be converted to orthometric heights and back.

Refer to the online help of LGO for more information on geoid models.



Geoid models are an approximation of the N value. In terms of accuracy, they may vary considerably and global models in particular should be used with caution. If the accuracy of the geoid model is not known it might be safer to use local control points with orthometric heights and apply a transformation to approximate the local geoid.

Geoid field file

Geoid field files may be used in the field to calculate orthometric heights out of ellipsoidal heights and vice versa.

CSCS model

Description

Country Specific Coordinate System models

- are tables of correction values to directly convert coordinates from WGS 1984 to local grid without the need of transformation parameters.
- take the distortions of the mapping system into account.
- are an addition to an already defined coordinate system.

Types of CSCS models

The correction values of a CSCS model can be applied at different stages in the coordinate conversion process. Depending on this stage, a CSCS model works differently. Three types

of CSCS models are supported by GPS1200. Their conversion process is as explained in the following table. Any suitable geoid model can be combined with a geodetic CSCS model. Refer to the online help of LGO for more information on CSCS models.

Type	Description
Grid	<ol style="list-style-type: none"> 1. Determination of preliminary grid coordinates by applying the specified transformation, ellipsoid and map projection. 2. Determination of the final local grid coordinates by applying a shift in Easting and Northing interpolated in the grid file of the CSCS model.
Cartesian	<ol style="list-style-type: none"> 1. Performing the specified transformation. 2. Determination of local cartesian coordinates by applying a 3D shift interpolated in the grid file of the CSCS model. 3. Determination of the final local grid coordinates by applying the specified local ellipsoid and map projection.
Geodetic	<ol style="list-style-type: none"> 1. Determination of local geodetic coordinates by applying a correction in latitude and longitude interpolated from the file of the CSCS model. 2. Determination of the final local grid coordinates by applying the local map projection. <p> Using a geodetic CSCS model excludes the use of a transformation in a coordinate system.</p>

CSCS field file

CSCS field files may be used in the field. They are extracted from the main CSCS model, which may be too big to fit on the instrument.

13.3

Accessing Coordinate System Management

Access

Select **Main Menu: Manage...\Coordinate Systems**.

OR

Press a hot key configured to access the screen **MANAGE Coordinate Systems**. Refer to "6.1 Hot Keys" for information on hot keys.

OR

Press **USER**. Refer to "6.2 USER Key" for information on the **USER** key.

OR

From a choicelist in some screens for example in **MANAGE New Job, Coord System** page.

OR

Press **CSYS (F6)** in some screens for example in **SURVEY Survey Begin**.

MANAGE Coordinate Systems

Listed are all coordinate systems stored in the database DB-X. Any unavailable information is shown as -----.

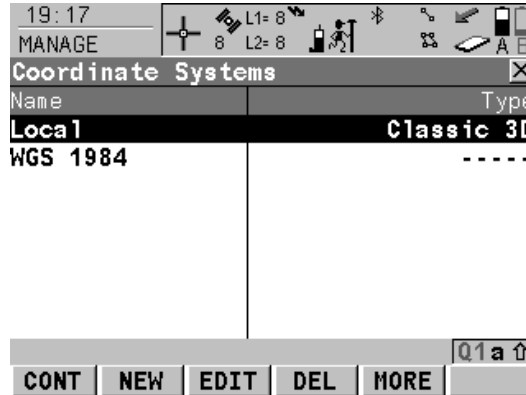

CONT (F1)

To select the highlighted coordinate system and to return to the previous screen. With a CompactFlash card inserted, the selected coordinate system will be attached to the active job.

NEW (F2)

To create a coordinate system manually. Refer to "13.4.1 Creating a New Coordinate System".

EDIT (F3)

To edit the highlighted coordinate system. Refer to "13.4.2 Editing a Coordinate System".

DEL (F4)

To delete the highlighted coordinate system.

MORE (F5)

To display information about the type of transformation used, the type of heights computed, the number of control points used for the determination and the date of when the coordinate system was created.

SHIFT SET-D (F4)

Available unless a default coordinate system is highlighted. To turn the highlighted coordinate system into a user defined default coordinate system stored in the receiver.

SHIFT DEFLT (F5)

To recall the deleted default coordinate systems.

Next step

IF a coordinate system	THEN
is to be selected	highlight the desired coordinate system. CONT (F1) closes the screen and returns to the screen from where MANAGE Coordinate Systems was accessed.
is to be created	highlight any coordinate system and NEW (F2) . Refer to "13.4.1 Creating a New Coordinate System".
is to be edited	highlight the coordinate system and EDIT (F3) . Refer to "13.4.2 Editing a Coordinate System".

13.4

13.4.1



Access

Create a coordinate system step-by-step

Coordinate Systems

Creating a New Coordinate System

Coordinate systems can be defined by manual creation or determined by calculation. In this chapter, the manual creation of coordinate systems is explained. Refer to "38 Determine Coordinate System - General" for information on the determination by calculation.

Coordinate systems with a Classic 3D transformation can be defined by manual creation.

Refer to "13.3 Accessing Coordinate System Management" to access **MANAGE Coordinate Systems**.

The following table explains the most common settings. Refer to the stated chapter for more information on screens.

Step	Description	Refer to chapter
1.	In MANAGE Coordinate Systems highlight a coordinate system. A copy of this coordinate system is taken for further configurations.	
2.	NEW (F2) to access MANAGE New Coordinate System .	
3.	MANAGE New Coordinate System <Name:> A unique name for the new coordinate system. The name may be up to 16 characters long and may include spaces.	

Step	Description	Refer to chapter
	<p><Residuals:> Available for transformations with control points. Manually entered transformations do not have control points. The method by which residuals are distributed throughout the transformation area. The transformation results become more realistic and any strain is dispersed in the transformation. <Residuals: 1/Dist>, <Residuals: 1/Dist²> and <Residuals: 1/Dist^{3/2}> distribute the residuals of the control points according to the distance between each control point and the newly transformed point. <Residuals: Multiquadratic> distributes the residuals using a multiquadratic interpolation approach.</p> <p><Transform:> The type of transformation.</p> <p><Ellipsoid:> Available unless projection <Type: Customised>. The local coordinates are based on this ellipsoid.</p> <p><Projection:> The map projection.</p> <p><Geoid Model:> The geoid model.</p> <p><CSCS Model:> The Country Specific Coordinate System model.</p> <p>Enter a name.</p>	<p>13.5</p> <p>13.6</p> <p>13.7</p> <p>13.8</p> <p>13.9</p>
4.	STORE (F1) stores the new coordinate system and returns to MANAGE Coordinate Systems .	

13.4.2

Editing a Coordinate System



The type of transformation of the selected coordinate system determines which elements of a coordinate system can be edited. The name of the coordinate system, the method of residual distribution and the geoid model in use are always editable.

Access

Refer to "13.3 Accessing Coordinate System Management" to access **MANAGE Coordinate Systems**.

Edit a coordinate system step-by-step

The following table explains the most common settings. Refer to the stated chapter for more information on screens.

Step	Description	Refer to chapter
1.	In MANAGE Coordinate Systems highlight a coordinate system to be edited.	
2.	EDIT (F3) to access MANAGE Edit Coordinate System .	
3.	MANAGE Edit Coordinate System The transformation type of the selected coordinate system determines the availability and the options of the subsequent fields. Most fields are identical with those for the creation of a new coordinate system. An additional field is: <Pre Transform:> Available for Twostep transformations. The name of a preliminary 3D transformation which is used together with the selected projection to obtain preliminary grid coordinates to be used for a final 2D transformation.	13.4.1

Step	Description	Refer to chapter
	Make the required changes.	
4.	STORE (F1) stores the changes and returns to MANAGE Coordinate Systems .	

13.5

13.5.1

Access step-by-step

Transformations

Accessing Transformation Management

Step	Description
1.	Refer to "13.3 Accessing Coordinate System Management" to access MANAGE Coordinate Systems .
2.	In MANAGE Coordinate Systems highlight a coordinate system to be edited.
3.	EDIT (F3)
4.	In MANAGE Edit Coordinate System highlight <Transform:> .
5.	ENTER to access MANAGE Transformations .

MANAGE Transformations

Listed are all Classic 3D transformations stored in the database DB-X. Any unavailable information is shown as -----.

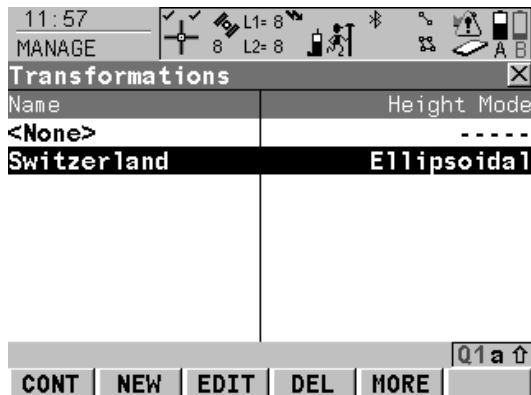

CONT (F1)

To select the highlighted transformation and to return to the previous screen.

NEW (F2)

To create a new transformation. Refer to "13.5.2 Creating a New Transformation".

EDIT (F3)

To edit the highlighted transformation. Refer to "13.5.3 Editing a Transformation".

DEL (F4)

To delete the highlighted transformation.

MORE (F5)

To display information about the type of heights computed and the number of control points used for the determination of the transformation.

SHIFT SET-D (F4)

To turn the highlighted transformation into a user defined default transformation stored in the receiver.

SHIFT DEFLT (F5)

To recall the deleted default transformations.

Next step

IF a transformation	THEN
is to be selected	highlight the desired transformation. CONT (F1) closes the screen and returns to the screen from where MANAGE Transformations was accessed.
is to be created	highlight any transformation and NEW (F2) . Refer to "13.5.2 Creating a New Transformation".
is to be edited	highlight the transformation and EDIT (F3) . Refer to "13.5.3 Editing a Transformation".

13.5.2

Creating a New Transformation



Classic 3D transformations can be created.

Access

Refer to "13.5.1 Accessing Transformation Management" to access **MANAGE Transformations**.

Create a transformation step-by-step

The following table explains the most common settings. Refer to the stated chapter for more information on screens.

Step	Description	Refer to chapter
1.	In MANAGE Transformations highlight a transformation. A copy of this transformation is taken for further configurations.	
2.	NEW (F2) to access MANAGE New Transformation .	
3.	MANAGE New Transformation, General page <Name:> A unique name for the new transformation. The name may be up to 16 characters long and may include spaces. <Type:> Output field. No other transformations than Classic 3D can be created. Enter a name.	38.1
4.	PAGE (F6) changes to the Parameters page.	
5.	MANAGE New Transformation, Parameters page Enter the known values of the transformation parameters.	
6.	PAGE (F6) changes to the More page.	

Step	Description	Refer to chapter
7.	<p>MANAGE New Transformation, More page</p> <p><Height Mode:> The type of heights to be computed.</p> <p><Transf Model:> The transformation model to be used. For <Transf Model: Molodensky-Bad>, additional input fields are available.</p> <p>Select at least a height mode and a transformation model.</p>	
	<p>CLEAR (F5) Available for <Transf Model: Molodensky-Bad>. To set the additional input fields to 0.</p>	
8.	<p>STORE (F1) stores the new transformation and returns to MANAGE Transformations.</p>	

13.5.3

Editing a Transformation

Access step-by-step

Step	Description
1.	Refer to "13.5.1 Accessing Transformation Management" to access MANAGE Transformations .
2.	In MANAGE Transformations highlight a transformation to be edited.
3.	EDIT (F3) to access MANAGE Edit Transformation .
4.	All following steps are identical with the creation of a new transformation. <Height Mode:> in MANAGE Edit Transformation , More page cannot be changed. Refer to "13.5.2 Creating a New Transformation". Follow the instructions in paragraph "Create a transformation step-by-step" from step 3. onwards.

13.6

13.6.1

Ellipsoids

Accessing Ellipsoid Management

Access step-by-step

Step	Description
1.	Refer to "13.3 Accessing Coordinate System Management" to access MANAGE Coordinate Systems .
2.	In MANAGE Coordinate Systems highlight a coordinate system to be edited.
3.	EDIT (F3) to access MANAGE Edit Coordinate System .
4.	In MANAGE Edit Coordinate System highlight <Ellipsoid:> .
5.	ENTER to access MANAGE Ellipsoids .

MANAGE Ellipsoids

Listed are all ellipsoids stored in the database DB-X.

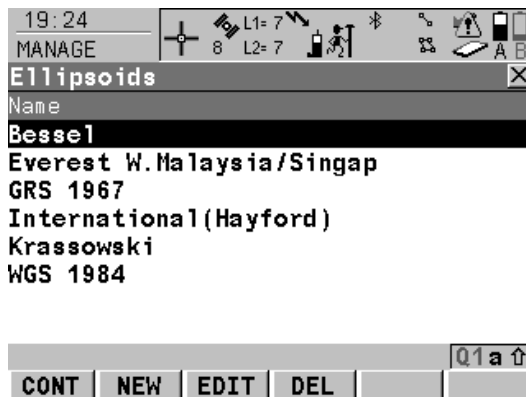

CONT (F1)

To select the highlighted ellipsoid and to return to the previous screen.

NEW (F2)

To create a new ellipsoid. Refer to "13.6.2 Creating a New Ellipsoid".

EDIT (F3)

To edit the highlighted ellipsoid. Refer to "13.6.3 Editing an Ellipsoid".

DEL (F4)

To delete the highlighted ellipsoid.

SHIFT SET-D (F4)

To turn the highlighted ellipsoid into a user defined default ellipsoid stored in the receiver.

SHIFT DEFLT (F5)

To recall the deleted default ellipsoids.

Next step

IF an ellipsoid	THEN
is to be selected	highlight the desired ellipsoid. CONT (F1) closes the screen and returns to the screen from where MANAGE Ellipsoids was accessed.
is to be created	highlight any ellipsoid and NEW (F2) . Refer to "13.6.2 Creating a New Ellipsoid".
is to be edited	highlight the ellipsoid and EDIT (F3) . Refer to "13.6.3 Editing an Ellipsoid".

13.6.2

Creating a New Ellipsoid

Access

Refer to "13.6.1 Accessing Ellipsoid Management" to access **MANAGE Ellipsoids**.

Create an ellipsoid step-by-step

The following table explains the most common settings. Refer to the stated chapter for more information on screens.

Step	Description	Refer to chapter
1.	In MANAGE Ellipsoids highlight an ellipsoid. A copy of this ellipsoid is taken for further configurations.	
2.	NEW (F2) to access MANAGE New Ellipsoid .	
3.	MANAGE New Ellipsoid <Name:> A unique name for the new ellipsoid. A name is mandatory and may be up to 16 characters long and may include spaces. <Axis a:> The semi-major axis a. <1/f:> The reciprocal value of flattening f. Enter a name.	
4.	STORE (F1) stores the new ellipsoid and returns to MANAGE Ellipsoids .	

13.6.3

Editing an Ellipsoid

Access step-by-step

Step	Description
1.	Refer to "13.6.1 Accessing Ellipsoid Management" to access MANAGE Ellipsoids .
2.	In MANAGE Ellipsoids highlight an ellipsoid to be edited.
3.	EDIT (F3) to access MANAGE Edit Ellipsoid .
4.	All following steps are identical with the creation of a new ellipsoid. Refer to "13.6.2 Creating a New Ellipsoid". Follow the instructions in paragraph "Create an ellipsoid step-by-step" from step 3. onwards.

13.7

13.7.1

Access step-by-step

Projections

Accessing Projection Management

Step	Description
1.	Refer to "13.3 Accessing Coordinate System Management" to access MANAGE Coordinate Systems .
2.	In MANAGE Coordinate Systems highlight a coordinate system to be edited.
3.	EDIT (F3) to access MANAGE Edit Coordinate System .
4.	In MANAGE Edit Coordinate System highlight <Projection:> .
5.	ENTER to access MANAGE Projections .

MANAGE Projections

Listed are all projections stored in the database DB-X. Any unavailable information is shown as -----.

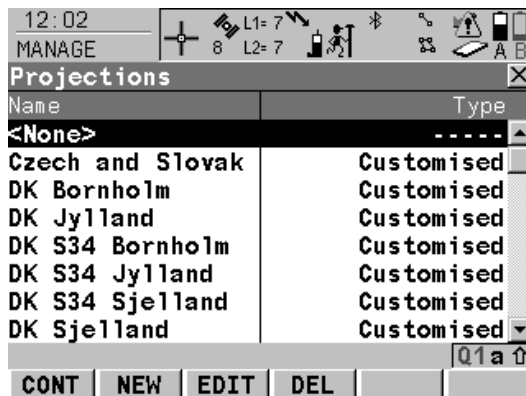

CONT (F1)

To select the highlighted projection and to return to the previous screen.

NEW (F2)

To create a new projection. Refer to "13.7.2 Creating a New Projection".

EDIT (F3)

To edit the highlighted projection. Refer to "13.7.3 Editing a Projection".

DEL (F4)

To delete the highlighted projection.

SHIFT SET-D (F4)

Available unless a default projection is highlighted. To turn the highlighted projection into a user defined default projection stored in the receiver.

SHIFT DEFLT (F5)

To recall the deleted default projections.

Description of columns

Column	Option	Description
Type		The projection type. Refer to standard surveying literature for details on projections.

Column	Option	Description
	Customised	Customised projection. Certain fixed projections which cannot be defined by any of the following options.
	Trans Mercator	Transverse Mercator. Conformal projection onto a cylinder with its axis lying on the equatorial plane. The cylinder is tangential to a meridian.
	UTM	Universal Transverse Mercator. Transverse Mercator projection with fixed zone-defining constants. The central meridian is selected automatically according to the selected zone number.
	Oblq Mercator	Oblique Mercator. Oblique Mercator Conformal projection onto a cylinder. The cylinder is tangent to any circle other than the equator or a meridian.
	Mercator	Mercator. Conformal projection onto a cylinder with its axis lying on a meridian plane. The cylinder is tangent to the sphere along the equator.
	Lambert 1 Para	Lambert 1 Parallel. Conformal projection onto a cone, with its axis coinciding with the z-axis of the ellipsoid.
	Lambert 2 Para	Lambert 2 Parallel. Conformal projection onto a cone, with its axis coinciding with the z-axis of the ellipsoid. The cone is secant to the sphere.

Column	Option	Description
	Cassini-Soldn	Soldner Cassini. Projection onto a cylinder. It is neither equal area nor conformal. The scale is true along the central meridian and along lines perpendicular to central meridian.
	Polar Stereo	Polar Stereographic. Conformal azimuthal projection onto a plane. The point of projection is on the surface of the ellipsoid diametrically opposite of the origin which is the centre of the projection.
	Double Stereo	Double Stereographic. Conformal azimuthal projection onto a plane. The point of projection is on the surface of the sphere diametrically opposite of the centre of the projection.
	RSO	Rectified Skewed Orthomorphic. This is a special type of Oblique Mercator projection.

Next step

IF a projection	THEN
is to be selected	highlight the desired projection. CONT (F1) closes the screen and returns to the screen from where MANAGE Projections was accessed.
is to be created	highlight any projection and NEW (F2) . Refer to "13.7.2 Creating a New Projection".

IF a projection	THEN
is to be edited	highlight the projection and EDIT (F3) . Refer to "13.7.3 Editing a Projection".

13.7.2

Creating a New Projection

Access

Refer to "13.7.1 Accessing Projection Management" to access **MANAGE Projections**.

Create a projection
step-by-step

The following table explains the most common settings. Refer to the stated chapter for more information on screens.

Step	Description	Refer to chapter
1.	In MANAGE Projections highlight a projection. A copy of this projection is taken for further configurations.	
2.	NEW (F2) to access MANAGE New Projection .	
3.	<p>MANAGE New Projection</p> <p><Name:> A unique name for the new projection. A name is mandatory and may be up to 16 characters long and may include spaces.</p> <p><Type:> The projection type. The setting for <Type:> determines the availability of the subsequent fields for the parameters of the projection.</p> <p>Enter a name.</p>	13.7.1
4.	STORE (F1) stores the new projection and returns to MANAGE Projections .	

13.7.3

Editing a Projection

Access step-by-step

Step	Description
1.	Refer to "13.7.1 Accessing Projection Management" to access MANAGE Projections .
2.	In MANAGE Projections highlight a projection to be edited.
3.	EDIT (F3) to access MANAGE Edit Projection .
4.	All following steps are identical with the creation of a new projection. <Type:> in MANAGE Edit Projection cannot be changed. Refer to "13.7.2 Creating a New Projection". Follow the instructions in paragraph "Create a projection step-by-step" from step 3. onwards.

13.8

Geoid Models

13.8.1

Overview

Use in the field

For use on the receiver in the field, geoid field files are created from the geoid model.

Geoid field file

The geoid separations in a geoid field file may be used in the field to change between ellipsoidal and orthometric heights.

Creation: In LGO with export onto a CompactFlash card or the internal memory of the receiver.

Extension: *.gem

Create geoid models on the receiver

Geoid models can be created on the receiver in one of three ways:

1.

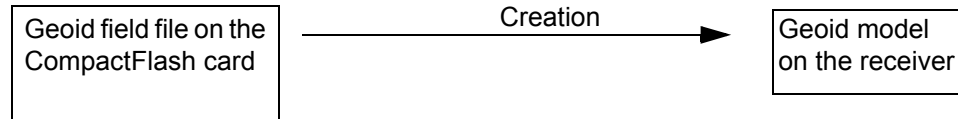

Here the geoid field file is stored on a CompactFlash card and can be used when the CompactFlash card is inserted in the receiver. It is recommended for large geoid field files. This method is explained in this chapter.

2.

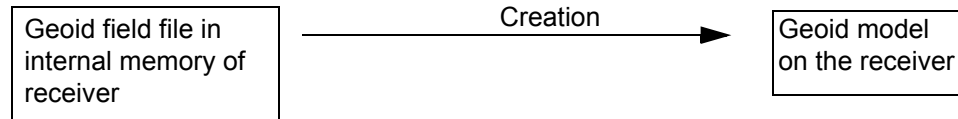

Here the geoid field file is stored in the internal memory of the receiver. It is recommended for large geoid field files. This method is also explained in this chapter.

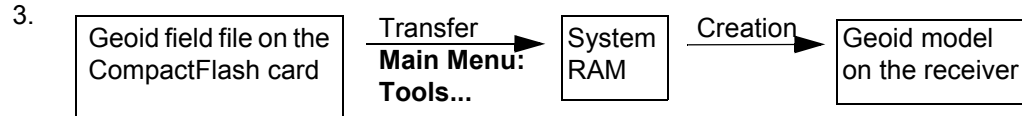

Here the geoid field file is transferred to the System RAM and can be used at any time. The total size of all files in the System RAM is restricted to 1 MB. Refer to "26 Tools...\Transfer Objects..." for information on how to transfer geoid field files to the System RAM on the receiver.

13.8.2

Accessing Geoid Model Management

Access step-by-step

Step	Description
1.	Refer to "13.3 Accessing Coordinate System Management" to access MANAGE Coordinate Systems .
2.	In MANAGE Coordinate Systems highlight a coordinate system to be edited.
3.	EDIT (F3) to access MANAGE Edit Coordinate System .
4.	In MANAGE Edit Coordinate System highlight <Geoid Model:> .
5.	ENTER to access MANAGE Geoid Models .

MANAGE Geoid Models

Listed are all geoid models stored in the database DB-X. Any unavailable information is shown as -----, for example if the geoid field file which was associated to the geoid model is not available on the CompactFlash card / internal memory.

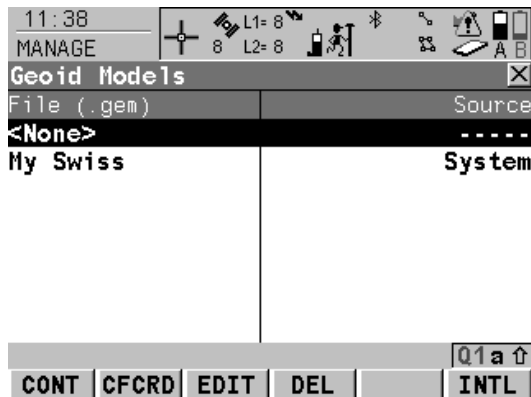

CONT (F1)

To select the highlighted geoid model and to return to the previous screen.

CFCRD (F2)

To create a new geoid model. The \DATA\GPS\GEOID directory on the CompactFlash card is automatically scanned for geoid field files. Refer to "13.8.3 Creating a New Geoid Model from the CompactFlash Card / Internal Memory".

EDIT (F3)

To view the highlighted geoid model. None of the fields can be edited. The geoid field file from which the geoid model was created must be stored in the System RAM or in the \DATA\GPS\GEOID directory on the Compact-Flash card / internal memory.

DEL (F4)

To delete the highlighted geoid model. The geoid field file which was associated with this geoid model is then also deleted.

INTL (F6)

To create a new geoid model. The \DATA\GPS\GEOID directory of the internal memory is automatically scanned for geoid field files. Refer to "13.8.3 Creating a New Geoid Model from the CompactFlash Card / Internal Memory".

Next step

IF a geoid model	THEN
is to be selected	highlight the desired geoid model. CONT (F1) closes the screen and returns to the screen from where MANAGE Geoid Models was accessed.
is to be created	CFCRD (F2) or INTL (F6) . Refer to "13.8.3 Creating a New Geoid Model from the CompactFlash Card / Internal Memory".

13.8.3

Creating a New Geoid Model from the CompactFlash Card / Internal Memory



Refer to "26 Tools...\Transfer Objects..." for information on how to transfer geoid field files to the System RAM on the receiver.

Requirement

At least one geoid field file with the extension *.gem is in the \DATA\GPS\GEOID directory on the CompactFlash card / internal memory. Refer to "13.2 Terminology" for information on geoid field files.

Create geoid model step-by-step

Step	Description
1.	Refer to "13.8.2 Accessing Geoid Model Management" to access MANAGE Geoid Models .
2.	CFCRD (F2) to scan the \DATA\GPS\GEOID directory on the CompactFlash card. OR INTL (F6) to scan the \DATA\GPS\GEOID directory of the internal memory.
3.	For each geoid field file on the CompactFlash card or in the internal memory, one geoid model is automatically created. The names given to the geoid models are those which were entered in LGO.  Existing geoid models are automatically overwritten by new models with the same name.
4.	The creation of a geoid model is finished.

13.9

CSCS Models

Use in the field

For use on the receiver in the field, CSCS field files are created from the CSCS model.

CSCS field file

CSCS field files may be used in the field to directly convert coordinates from WGS 1984 to local grid without the need of transformation parameters.

Creation: In LGO with export onto a CompactFlash card or the internal memory of the receiver.

Extension: *.csc



The creation of CSCS models on the receiver and the functionality of all screens and fields are similar to those for geoid models. Refer to "13.8 Geoid Models".

The directory on the CompactFlash card / internal memory for CSCS field files with the extension *.csc is \DATA\GPS\CSCS.

14**Manage...\Configuration Sets****14.1****Overview****Description**

The receiver has numerous user configurable parameters and functions. This allows a variety of preferences to be addressed. The configuration of the parameters and functions for an individual measuring technique are combined in a configuration set.

Default configuration sets

Default configuration sets exist on the instrument. They use standard settings for the majority of application programs. Default configuration sets can be edited and deleted. It is always possible to restore the default configuration sets.

User defined configuration sets

New configuration sets can be created. The configuration set wizard assists in editing configuration sets.

Edit outside the configuration set wizard

Parameters and functions can be edited without going through the configuration set wizard. Refer to "14.4 Editing a Configuration Set" for more information.



Each application program can be configured separately. Application program settings are configured in the application program but are stored as part of the configuration set. Refer to "36 Application Programs - General".

14.2

Accessing Configuration Set Management

Access

Select **Main Menu: Manage...Configuration Sets**.

OR

Press a hot key configured to access the screen **MANAGE Configuration Sets**. Refer to "6.1 Hot Keys" for information on hot keys.

OR

Press **USER**. Refer to "6.2 USER Key" for information on the **USER** key.

OR

From a choicelist in some screens for example the begin screen of application programs.

MANAGE Configuration Sets

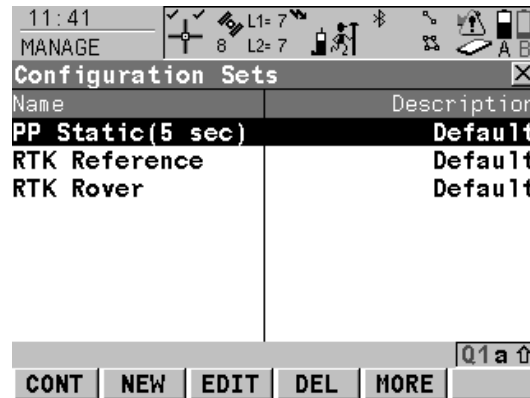

CONT (F1)

To select the highlighted configuration set and to return to **GPS1200 Main Menu**.

NEW (F2)

To create a new configuration set. Refer to "14.3 Creating a New Configuration Set".

EDIT (F3)

To edit a configuration set. Accesses the first screen of the sequential configuration set wizard for the highlighted configuration set. Default configuration sets can be edited. Refer to "14.4 Editing a Configuration Set".

DEL (F4)

To delete the highlighted configuration set.

MORE (F5)

To display information about the description, the creator and the creation date of the configuration set.

SHIFT SET-D (F4)

Available unless a default configuration set is highlighted. To turn the highlighted configuration sets into a user defined default configuration set stored in the receiver.

SHIFT DEFLT (F5)

To recall previously deleted default configuration sets and to reset default configuration sets to the default settings. User defined configuration sets are not affected.

Next step

IF a configuration set	THEN
is to be selected	select the desired configuration set. CONT (F1) to close the screen and to return to the screen from where MANAGE Configuration Sets was accessed.
is to be created	highlight any configuration set and NEW (F2) . Refer to "14.3 Creating a New Configuration Set".
is to be edited	highlight the configuration set and EDIT (F3) . Refer to "14.4 Editing a Configuration Set".

14.3

14.3.1

Configuration step-by-step

Creating a New Configuration Set

Initial Steps

The following table explains the most common settings. Refer to the stated chapter for more information on individual screens.

Step	Description	Refer to chapter
1.	Refer to "14.2 Accessing Configuration Set Management" to access MANAGE Configuration Sets .	
2.	In MANAGE Configuration Sets highlight a configuration set. A copy of this configuration set is taken for further configurations.	14.2
3.	NEW (F2) to access MANAGE New Configuration Set . A copy of the highlighted configuration set is created.	
4.	MANAGE New Configuration Set <Name:> A unique name for the new configuration set. <Description:> A detailed description of the configuration set, since the name of a configuration set is usually an abbreviation. Input optional. <Creator:> The person's name who creates the new configuration set. Input optional. Enter a name.	
5.	STORE (F1) stores the new configuration set with the entered name. Starts the sequential configuration set wizard.	

Step	Description	Refer to chapter
6.	CONFIGURE Wizard Mode <Wizard Mode: Reduced>	21.1
	LIST (F6) accesses CONFIGURE Quick Access . Lists all screens within the configuration set. Allows to access these individual screens and to change settings.	
7.	CONT (F1)	
8.	Is the configuration for a static operation? Is the configuration for a post-processed kinematic operation? Is the configuration for a real-time reference operation? Is the configuration for a real-time rover operation?	14.3.2 14.3.3 14.3.4 14.3.5

14.3.2

Configuration Set for Static Operations

Description

Configuring the receiver for post-processed static operations.

Configuration step-by-step

The following table provides recommendations for the most common settings. For all other fields, the default settings can be used. Refer to the stated chapter for more information on individual screens.

Step	Description	Refer to chapter
1.	Refer to "14.3 Creating a New Configuration Set". Follow the instructions in paragraph "Configuration step-by-step" up to step 7.	
2.	CONFIGURE Real-Time Mode <R-Time Mode: None>	22.3
3.	CONT (F1)	
4.	CONFIGURE Antenna & Antenna Heights <Antenna: AX1202 GG Tripod> or <Antenna: AX1202 GG Pillar> <Default Ht: 0.0000> <Meas Type: Vertical> <Moving Ht: 0.0000>	20.1
5.	CONT (F1)	
6.	CONFIGURE Display Settings Select the display masks to be used with this configuration set.	21.5
	DMASK (F3) configures the selected display mask.	

Step	Description	Refer to chapter
7.	CONT (F1)	
8.	CONFIGURE Coding & Linework <Quick Code: Off> <Attributes: Default Values>	19.3
9.	CONT (F1)	
10.	CONFIGURE Logging of Raw Obs <Log Raw Obs: Static Only> <ul style="list-style-type: none"> • For static operations with long baselines and over long time: <Log Rate: 15.0s> or <Log Rate: 30.0s> • For reference stations for post-processed ensure that <Log Rate:> is the same rate as at the rover. 	19.5
11.	FILES (F6)	
12.	CONFIGURE Raw Observation Files <Use Separate Files: No>	19.5
13.	CONT (F1) leads back to CONFIGURE Logging of Raw Obs	
14.	CONT (F1)	
15.	CONFIGURE Point Occupation Settings <Pt Occupation: Normal> <Auto OCCUPY: No> <Auto STOP: No>	19.6

Step	Description	Refer to chapter
	<Auto STORE: No>	
16.	CONT (F1)	
17.	CONFIGURE Quality Control Settings <Allow 2D Posn: Yes>	19.4
18.	CONT (F1)	
19.	CONFIGURE ID Templates <Survey Pts: No Template Used> <Auto Pts: Time & Date> <Auxil Pts: No Template Used> <Lines: No Template Used> <Areas: No Template Used>	
20.	CONT (F1)	
21.	MANAGE Configuration Sets The adapted configuration set is highlighted.	
22.	CONT (F1) closes the screen and returns to GPS1200 Main Menu . The highlighted configuration set is then the active configuration set.	

14.3.3

Configuration Set for Post-Processed Kinematic Operations

Description

Configuring the receiver for post-processed kinematic operations.

Configuration step-by-step

The following table provides recommendations for the most common settings. For all other fields, the default settings can be used. Refer to the stated chapter for more information on individual screens.

Step	Description	Refer to chapter
1.	Refer to "14.3 Creating a New Configuration Set". Follow the instructions in paragraph "Configuration step-by-step" up to step 7.	
2.	CONFIGURE Real-Time Mode <R-Time Mode: None>	22.3.2
3.	CONT (F1)	
4.	CONFIGURE Antenna & Antenna Heights <Antenna: AX1202 GG Pole> <Default Ht: 2.0000> <Meas Type: Vertical> <Moving Ht: 2.0000>	20.1
5.	CONT (F1)	
6.	CONFIGURE Display Settings Select the display masks to be used with this configuration set.	21.5
	DMASK (F3) configures the selected display mask.	

Step	Description	Refer to chapter
7.	CONT (F1)	
8.	CONFIGURE Coding & Linework <Quick Code: Off> <Attributes: Default Values>	19.3
9.	CONT (F1)	
10.	CONFIGURE Logging of Raw Obs <Log Raw Obs: Static & Moving>	19.5
11.	FILES (F6)	
12.	CONFIGURE Raw Observation Files <Use Separate Files: No>	19.5
13.	CONT (F1) leads back to CONFIGURE Logging of Raw Obs	
14.	CONT (F1)	
15.	CONFIGURE Point Occupation Settings <Pt Occupation: Normal> <Auto OCCUPY: No> <Auto STOP: No> <Auto STORE: No>	19.6
16.	CONT (F1)	
17.	CONFIGURE Quality Control Settings	19.4

Step	Description	Refer to chapter
	<Allow 2D Posn: Yes>	
18.	CONT (F1)	
19.	CONFIGURE ID Templates <Survey Pts: No Template Used> <Auto Pts: Time & Date> <Auxil Pts: No Template Used> <Lines: No Template Used> <Areas: No Template Used>	
20.	CONT (F1)	
21.	MANAGE Configuration Sets The adapted configuration set is highlighted.	
22.	CONT (F1) closes the screen and returns to GPS1200 Main Menu . The highlighted configuration set is then the active configuration set.	

14.3.4

Configuration Set for Real-Time Reference Operations

Description



Configuring the receiver for real-time reference operations.





Real-time reference operations are possible with a GX1230 or a GX1230 GG. It provides real-time to centimetre level.

In order to use a GX1210, a GX1220 or a GX1220 GG for real-time reference operations, the RTCM v3 option must be activated. A GX1210, GX1220 or GX1220 GG provides DGPS to 0.25 - 1 m level.

Configuration step-by-step

The following table provides recommendations for the most common settings. For all other fields, the default settings can be used. Refer to the stated chapter for more information on individual screens.

Step	Description	Refer to chapter
1.	Refer to "14.3 Creating a New Configuration Set". Follow the instructions in paragraph "Configuration step-by-step" up to step 7.	
2.	CONFIGURE Real-Time Mode <R-Time Mode: Reference> <R-Time Data: Leica>	22.3.3
3.	RATES (F3)	
4.	CONFIGURE Data Rates <Data: 1.0s> <Coords: 10s> <Info: 60s>	22.3.3

Step	Description	Refer to chapter
5.	CONT (F1) leads back to CONFIGURE Real-Time Mode	
	DEVCE (F5) to configure devices.	23.2
	REF (F2) configures additional reference station options like time slicing.	22.3.3
	SHIFT RT-2 (F2) configures a second real-time device.	14.3.4
6.	CONT (F1)	
	The sequence of screens varies slightly when a second real-time device was configured before the configuration set wizard was started.	
7.	The next screen depends on the setting for <Device:> in CONFIGURE Real-Time Mode . Set the parameters required.	23.2
8.	CONT (F1)	
9.	CONFIGURE Antenna & Antenna Heights <Antenna: AX1202 GG Tripod> <Default Ht: 0.0000> <Meas Type: Vertical>	20.1
10.	CONT (F1)	
11.	CONFIGURE Coding & Linework <Quick Code: Off>	19.3

Step	Description	Refer to chapter
	<Attributes: Default Values>	
12.	CONT (F1)	
13.	CONFIGURE Logging of Raw Obs <Log Raw Obs: No>	19.5
14.	CONT (F1)	
15.	MANAGE Configuration Sets The adapted configuration set is highlighted.	
16.	CONT (F1) closes the screen and returns to GPS1200 Main Menu . The highlighted configuration set is then the active configuration set.	

14.3.5

Configuration Set for Real-Time Rover Operations

Description

Configuring the receiver for real-time rover operations.



Real-time rover operations are possible with a GX1230 or a GX1230 GG. It provides real-time to centimetre level.

In order to use a GX1210, a GX1220 or a GX1220 GG for real-time rover operations, the RTCM v3 option must be activated. A GX1210, GX1220 or GX1220 GG provides DGPS to 0.25 - 1 m level.

Configuration step-by-step

The following table provides recommendations for the most common settings. For all other fields, the default settings can be used. Refer to the stated chapter for more information on individual screens.

Step	Description	Refer to chapter
1.	Refer to "14.3 Creating a New Configuration Set". Follow the instructions in paragraph "Configuration step-by-step" up to step 7.	
2.	CONFIGURE Real-Time Mode <R-Time Mode: Rover> <R-Time Data: Leica>	22.3.4
	ROVER (F2) configures additional rover station options such as using a reference network.	22.3.4
	DEVCE (F5) to configure devices.	23.2
3.	CONT (F1)	

Step	Description	Refer to chapter
4.	The next screen depends on the setting for <Device:> in CONFIGURE Real-Time Mode . Set the parameters required.	23.2
5.	CONT (F1)	
6.	CONFIGURE Antenna & Antenna Heights <Antenna: AX1202 GG Pole> <Default Ht: 2.0000> <Meas Type: Vertical>	20.1
7.	CONT (F1)	
8.	CONFIGURE Display Settings Select the display masks to be used with this configuration set.	19.2
	DMASK (F3) configures the selected display mask.	
9.	CONT (F1)	19.4
10.	CONFIGURE Coding & Linework <Quick Code: Off> <Attributes: Default Values>	19.3
11.	CONT (F1)	
12.	CONFIGURE Logging of Raw Obs <Log Raw Obs: Never>	19.5

Step	Description	Refer to chapter
13.	CONT (F1)	
14.	CONFIGURE Point Occupation Settings <Pt Occupation: Normal> <Auto OCCUPY: No> <Auto STOP: No> <Auto STORE: No>	19.6
15.	CONT (F1)	
16.	CONFIGURE Quality Control Settings <Allow 2D Posn: Yes>	19.4
17.	CONT (F1)	
18.	CONFIGURE ID Templates <Survey Pts: No Template Used> <Auto Pts: Time & Date> <Auxil Pts: No Template Used> <Lines: No Template Used> <Areas: No Template Used>	
19.	CONT (F1)	
20.	MANAGE Configuration Sets The adapted configuration set is highlighted.	

Step	Description	Refer to chapter
21.	CONT (F1) closes the screen and returns to GPS1200 Main Menu . The highlighted configuration set is then the active configuration set.	

14.4

Editing a Configuration Set

Description

There are two possibilities to edit a configuration set.

Using the **configuration set wizard** to be lead through the steps.

OR

Outside of the **configuration set wizard**. Each screen can be accessed separately without being guided through the steps.

Access step-by-step with using configuration set wizard

Step	Description
1.	Refer to "14.2 Accessing Configuration Set Management" to access MANAGE Configuration Sets .
2.	In MANAGE Configuration Sets highlight a configuration set to be edited.
3.	EDIT (F3) to access CONFIGURE Wizard Mode . This starts the sequential configuration set wizard.
4.	All following steps are identical with the creation of a new configuration set. Refer to "14.3.1 Initial Steps". Follow the instructions in paragraph "Configuration step-by-step" from step 6. onwards.

Access without using the configuration set wizard

The currently active configuration set can be edited. Choose one of the following options and access the required screens to edit the configuration set.

Select **Main Menu: Config...** Refer to "7 Main Menu".

OR

From inside an application program press **USER** and then **CONF (F2)**.

OR

In **CONFIGURE Wizard Mode**, press **LIST (F6)**. Refer to "14.3 Creating a New Configuration Set".

15**Manage...\Antennas****15.1****Overview****Description**

- Leica Geosystems antennas are predefined as default and can be selected from a list.
- Additional antennas can be defined.
- Default antennas contain an elevation dependent correction model.
- New antenna correction models can be set up and transferred to the receiver using LGO.

Default antennas

All Leica Geosystems antennas are supported.

Active antenna

One antenna is always considered as the active antenna.

15.2

Accessing Antenna Management

Access

Select **Main Menu: Manage...Antennas**.

OR

Press a hot key configured to access the screen **MANAGE Antennas**. Refer to "6.1 Hot Keys" for information on hot keys.

OR

Press **USER**. Refer to "6.2 USER Key" for information on the **USER** key.

OR

From a choicelist in some screens for example the **SURVEY Survey Begin** screen.

MANAGE Antennas

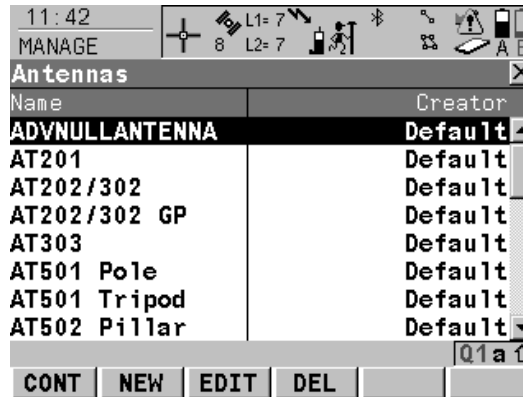

CONT (F1)

To select the highlighted antenna and to return to the previous screen.

NEW (F2)

To define a new antenna. Refer to "15.3 Creating a New Antenna".

EDIT (F3)

To edit the highlighted antenna. It is not possible to edit default antennas. Refer to "15.4 Editing an Antenna".

DEL (F4)

To delete the highlighted antenna. It is not possible to delete default antennas.

SHIFT DEFLT (F5)

To recall previously deleted default antennas and to reset default antennas to the default settings. User defined antennas are not affected.

Next step

IF an antenna	THEN
is to be selected	highlight the desired antenna. CONT (F1) closes the screen and returns to the screen from where MANAGE Antennas was accessed.
is to be created	highlight the antenna with offset characteristics similar to those required by the new antenna. NEW (F2) creates a new antenna. Refer to "15.3 Creating a New Antenna".
is to be edited	highlight the desired antenna. EDIT (F3) . Refer to "15.4 Editing an Antenna".

15.3

Creating a New Antenna

Access

Refer to "15.2 Accessing Antenna Management" to access **MANAGE Antennas**.

Create new antenna step-by-step

The following table explains the most common settings. Refer to the stated chapter for more information on screens.

Step	Description	Refer to chapter
1.	In MANAGE Antennas press NEW (F2) .	
2.	MANAGE New Antenna, General page <Name:> A unique name for the new antenna. <Hz Offset:> Horizontal offset of measurement reference point. <V Offset:> Vertical offset of measurement reference point. <L1 PhOffset:> Offset of L1 phase centre. <L2 PhOffset:> Offset of L2 phase centre. <Copy Additional Corrections:> Allows additional corrections to be copied from the antenna which was highlighted when MANAGE New Antenna was accessed. All offsets are copied from the antenna which was highlighted when MANAGE New Antenna was accessed.	2
3.	PAGE (F6) to access MANAGE New Antenna, IGS page.	
4.	MANAGE New Antenna, IGS page <IGS Name:> The International GPS Service name of the antenna.	

Step	Description	Refer to chapter
	<p><Serial Number:> The serial number of the antenna.</p> <p><Set Up Number:> The set up number of the antenna. This identifies the version number of the current calibration.</p> <p>The combination of values typed in here provides a unique standardised ID for the antenna being used.</p>	
5.	STORE (F1) stores the new antenna and returns to MANAGE Antennas .	

15.4

Editing an Antenna

Access

Refer to "15.2 Accessing Antenna Management" to access **MANAGE Antennas**.

Edit antenna step-by-step

Step	Description
1.	In MANAGE Antennas highlight the antenna to be edited.
2.	EDIT (F3) to access MANAGE Edit Antenna, General page.
3.	MANAGE Edit Antenna All the following steps are identical with the creation of a new antenna. All fields can be edited except those of Leica default antennas. Refer to "15.3 Creating a New Antenna". Follow the instructions from step 2. onwards.

16 Convert...\Export Data from Job

16.1

Overview

Description

This screen lists all the exporters loaded.

Data can be exported

- to a file on the CompactFlash card.
- to a file on the internal memory if fitted.
- via RS232 to a Leica TPS400/700 instrument. Refer to "22.6 Export Job" for information on how to configure the interface.

Export format

Format	Characteristic	Description
Custom ASCII	Export variables	Refer to the online help of LGO.
	Format definition	Composed individually as format file using LGO. Refer to the online help of LGO for information on creating format files.
	Units	Defined within the format file.
	Coordinate conversion	All coordinate types are supported.
	Height	All height types are supported. If the desired height cannot be computed, the default value for the missing variable is output.

Format	Characteristic	Description
	<p>Specialities:</p> <p>Points in file outside of CSCS model</p> <p>Points in file outside of geoid model</p>	<p>The default value for missing variable is output.</p> <p>The default value for missing variable is output, also if a geoid separation is available.</p>
DXF	<p>Coordinate conversion</p> <p>Height</p> <p>Specialities:</p> <p>Points in file outside of CSCS model</p> <p>Points in file outside of geoid model</p>	<p>All points are converted to local grid position using the coordinate system.</p> <p>Orthometric height and ellipsoidal height are supported.</p> <p>Points in LocalGrid position without CSCS transformation are exported.</p> <p>The ellipsoidal height is exported.</p>

16.2

Accessing the Data Export Functionality

Access

Select **Main Menu: Convert...\Export Data from Job**.

OR

Press a hot key configured to access the screen **EXPORT Export Data from Job**. Refer to "6.1 Hot Keys" for information on hot keys.

OR

Press **USER**. Refer to "6.2 USER Key" for information on the **USER** key.

Next step

IF exporting to	THEN
custom ASCII format	Refer to "16.3 Exporting Data from a Job to a Custom ASCII Format".
another device	Refer to "16.4 Exporting Data from a Job to another Device".
DXF format	Refer to "16.5 Exporting Data in DXF Format".

16.3

Exporting Data from a Job to a Custom ASCII Format

Description

The settings on this screen define the data that is converted and exported and what format is used.

Data is exported from the selected job. Currently active view, filter and sort settings are applied. The points that are exported are those that are visible in **MANAGE Data: Job Name**.

Requirements

At least one format file was created using LGO and has been transferred to the System RAM.

Access



Refer to "16.2 Accessing the Data Export Functionality" to access **EXPORT Export ASCII Data from Job**.

Export data step-by-step

The following table explains the most common settings. Refer to the stated chapter for more information on screens.

Step	Description	Refer to chapter
1.	EXPORT Export ASCII Data from Job <Export To: CF Card> or <Export To: Internal Memory> <Directory:> Available for <Export To: CF Card> . The data can be exported to the \Data, the \GSI or the root directory. Data must be stored to the \GSI directory in order to read it in a TPS1100. For <Export To: Internal Memory> , the data is always exported to the \Data directory.	

Step	Description	Refer to chapter
	<p><Job:> All jobs from Main Menu: Manage...\Jobs can be selected. When in this choicelist press CFCRD (F6) or INTL (F6) to select a job from a different memory device.</p> <p><Coord System:> The coordinate system currently attached to the selected <Job:>.</p> <p><Format File:> The format files currently available in the System RAM.</p> <p><File Name:> The name of the file to which the data should be exported. The name is automatically suggested based on the job name to be exported and an extension. The default extension to be used can be configured in the EXPORT Define ASCII Export panel using CONF (F2).</p> <p>Select the job to be exported and enter an individual file name or accept the suggested name.</p>	
2.	Highlight <Format File:> and ENTER .	
3.	<p>EXPORT Format Files</p> <p>All format files available in the System RAM are listed. Select the format file to be used.</p>	
	DEL (F4) deletes the highlighted format file from the System RAM.	
4.	CONT (F1) selects the highlighted format file and leads back to EXPORT Export ASCII Data from Job .	

Step	Description	Refer to chapter
5.	FILT (F4) to set the sort and filter settings for export. Accesses EXPORT Sorts & Filters .	
6.	EXPORT Sorts & Filters, Points page <Sort:> The order in which points, lines and areas are exported. <Filter:> Defines which points are exported.	9.6
	PAGE (F6) changes to the Lines or Areas page. The setting for <Filter:> on these pages defines which lines or areas are exported.	
7.	CONT (F1) accepts the changes and returns to EXPORT Export ASCII Data from Job .	
	CSYS (F6) accesses EXPORT Coordinate Systems . To update the coordinate system in which the coordinates are exported.	13.3
8.	CONT (F1) exports the data.	
9.	Information message: Are more data to be exported? <ul style="list-style-type: none"> • If yes, continue with step 10. • If no, continue with step 11. 	
10.	YES (F4) . Repeat steps 1. to 9.	
11.	NO (F6) returns to the GPS1200 Main Menu .	

16.4

Exporting Data from a Job to another Device

General



Data can be transferred to a Leica TPS400/700 via RS232.

Access

Refer to "16.2 Accessing the Data Export Functionality" to access **EXPORT Export ASCII Data from Job**.

Export data step-by-step

The following table explains the most common settings. Refer to the stated chapter for more information on screens.

Step	Description	Refer to chapter
1.	EXPORT Export ASCII Data from Job <Export To: RS232> <Port:> displays the port currently configured to be used with RS232.	16.1
	IFACE (F5) accesses CONFIGURE Export Job Interface . To choose the port and device to which the data should be exported.	
2.	FILT (F4) to set the sort and filter settings for export. Accesses EXPORT Sorts & Filters .	
3.	EXPORT Sorts & Filters, Points page <Sort:> The order in which points, lines and areas are exported. <Filter:> Defines which points are exported.	9.6
	PAGE (F6) changes to the Lines or Areas page. The setting for <Filter:> on these pages defines which lines or areas are exported.	

Step	Description	Refer to chapter
4.	CONT (F1) accepts the changes and returns to EXPORT Export ASCII Data from Job .	
	CSYS (F6) accesses EXPORT Coordinate Systems . To update the coordinate system in which the coordinates are exported.	13.3
5.	CONT (F1) exports the data.	
6.	Information message: Are more data to be exported? <ul style="list-style-type: none"> • If yes, continue with step 7. • If no, continue with step 8. 	
7.	YES (F4) . Repeat step 1. to 6.	
8.	NO (F6) returns to the GPS1200 Main Menu .	

16.5

Exporting Data in DXF Format

General

Data can be exported to a DXF file in the \DATA directory of the CompactFlash card or the internal memory, if fitted.



Access

Refer to "16.2 Accessing the Data Export Functionality" to access **DXF Export Export DXF from Job**.

Export data step-by-step

The following table explains the most common settings. Refer to the stated chapter for more information on screens.

Step	Description
1.	<p>DXF Export Export DXF from Job</p> <p><Job:> All jobs from Main Menu: Manage...\Jobs can be selected. When in this choicelist press CFCRD (F6) or INTL (F6) to select a job from a different memory device.</p> <p><Coord System:> The coordinate system currently attached to the selected <Job:>.</p> <p><File name:> The name of the file to which the data should be exported. The name is automatically suggested based on the job name to be exported and the extension dxf.</p> <p>Select the job to be exported and enter an individual file name or accept the suggested name.</p>
	<p>CONF (F2) accesses Configuration, Export page.</p> <p><Points:> Defines if points are exported.</p> <p><Lines:> Defines if lines are exported.</p>

Step	Description
 	<p><Areas:> Defines if areas are exported.</p> <p><Filter:> Defines which points are exported.</p> <p>PAGE (F6) changes to the DXF page.</p> <p><Lines & Areas:> Defines if lines and areas are exported as Line or Polyline entities.</p> <p><LGO Symbols:> Defines if a block is created for each point with the same icons used in LGO.</p> <p><Symbol Size:> Defines the size used for creation of the LGO symbols.</p> <p><Dimensions:> Defines the dimension of the DXF file.</p> <p><DXF Layer:> Defines the DXF Layer as <Default>, <Code Group> or <Code>.</p> <p>PAGE (F6) changes to the Labels page. The settings on this page define which labels with information (Point ID, Coords, Height and Pt Code) for each point are exported. For each label the DXF layer name and the color can be defined. Additionally the decimals can be defined for the Coords and Height label.</p>
2.	CONT (F1) accepts the changes and returns to DXF Export Export DXF from Job .
3.	CONT (F1) exports the data.
	Message: Do not remove CF Card!
4.	<p>Information message: Are more data to be exported?</p> <p>If yes, continue with step 5.</p> <p>If no, continue with step 6.</p>

Step	Description
5.	YES (F6) . Repeat steps 1. to 4.
6.	NO (F4) returns to the GPS1200 Main Menu .

17

Convert...\Import Data to Job

17.1

Overview

Description

This screen lists all the importers loaded. The data to import must be stored on the Compact-Flash card.

Data can be imported to a job

- on the CompactFlash card.
- on the internal memory, if fitted.

Import formats

Format	Characteristic	Description
ASCII	Import variables	Point ID, grid coordinates, thematical codes. No free codes, no attributes.
	Format definition	Free format. Use and order of variables and delimiter can be defined during import.
	Units	As currently configured on the receiver
	Height	Orthometric or ellipsoidal
	Specialities	
	Local heights but no coordinates in file	Points are imported without coordinates but with local height and code if available.
	Coordinates but no heights in file	Points are imported without height but with coordinates and code if available.

Format	Characteristic	Description
	Neither coordinates nor heights in file	No import
	No point ID's in file	No import
GSI8 GSI16	Import variables	Point ID (WI 11), local coordinates (WI 81, WI 82, WI 83), thematic codes (WI 71). No free codes, no attributes. Example for GSI8: 110014+00001448 81..01+00001363 82..01-00007748 83..01-00000000 71....+000sheep
	Format definition	Fixed format. Easting and Northing can be switched during import.
	Units	As defined in the GSI file
	Heights	Orthometric or ellipsoidal
	Specialities	
	Local heights but no coordinates in file	Points are imported without coordinates but with local height and code if available.
	Coordinates but no heights in file	Points are imported without height but with coordinates and code if available.
	Neither coordinates nor heights in file	No import
	No point ID's in file	No import
DXF	Import variables	Block, point, line, arc, polyline. Local coordinates. No free codes, no attributes.

Format	Characteristic	Description
	Format definition	Fixed format (X/Y/Z).
	Units	Not predefined.
	Heights	Z value imported as orthometric.
	Specialities	
	Neither coordinates nor heights in file	No import

Checks

Points are always imported with the class **CTRL** and a coordinate quality of ----. Refer to "9.3.1 Terminology".

While importing points to a job, checks are performed against point ID, class and coding of points already existing in the job.

Case 1: Point already exists in database with class CTRL

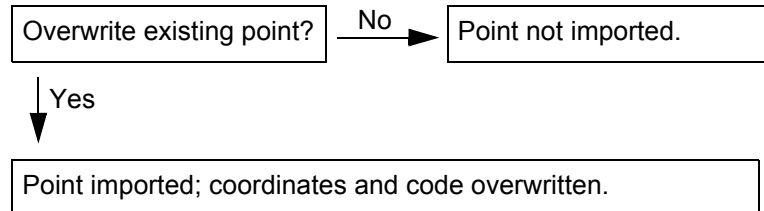

Case 2: Point already exists in database with a class other than CTRL

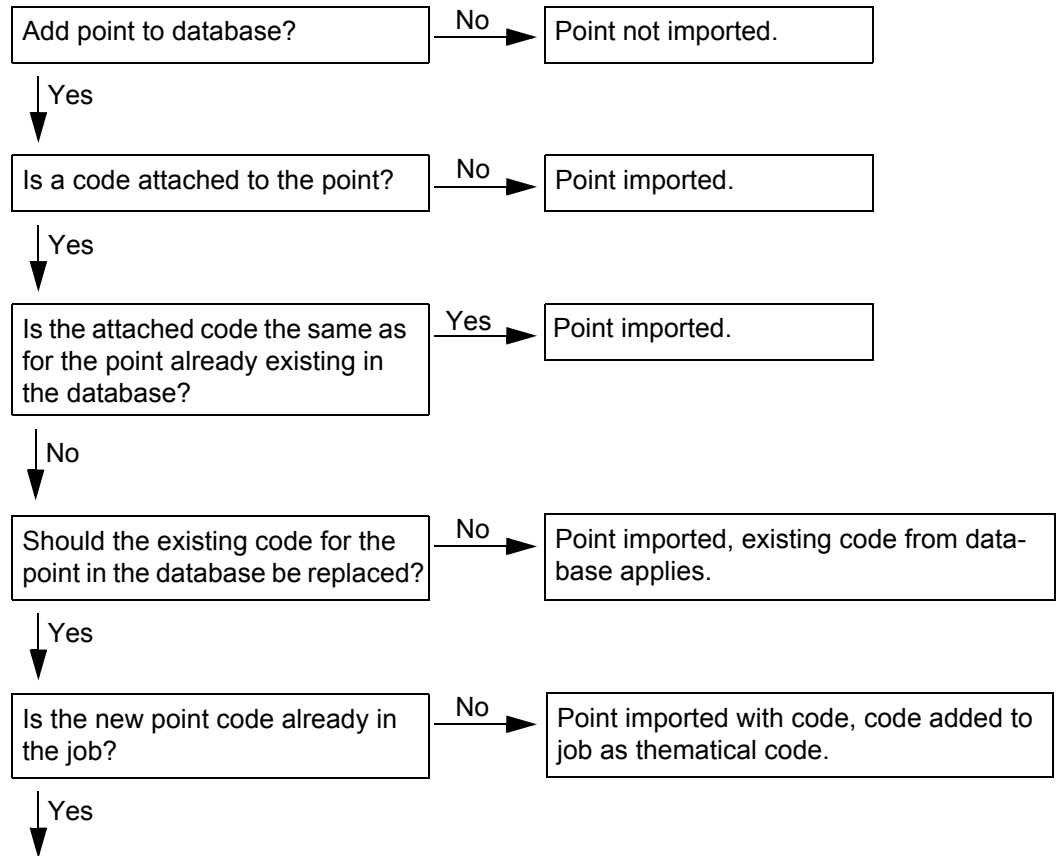

Point imported with code.

17.2

Accessing the Data Import Functionality

Access

Select **Main Menu: Convert...\\Import Data to Job**.

OR

Press a hot key configured to access the screen **IMPORT Import Data to Job**. Refer to "6.1 Hot Keys" for information on hot keys.

OR

Press **USER**. Refer to "6.2 USER Key" for information on the **USER** key.

Next step

IF importing data in	THEN
ASCII format	Refer to "17.3 Importing Data in ASCII Format".
GSI format	Refer to "17.4 Importing Data in GSI Format".
DXF format	Refer to "17.5 Importing Data in DXF Format".

17.3

Importing Data in ASCII Format

Requirements



At least one ASCII file with any file extension is stored in the \DATA directory of the CompactFlash card.

Access

Refer to "17.2 Accessing the Data Import Functionality" to access **IMPORT Import ASCII/GSI Data to Job**.

Import data step-by-step

Step	Description
1.	<p>IMPORT Import ASCII/GSI Data to Job</p> <p><Import: ASCII Data></p> <p><From File:> All files in the \DATA directory on the CompactFlash card can be selected.</p> <p><To Job:> Choosing a job as destination for import makes this job the active job. All jobs from Main Menu: Manage...Jobs can be selected.</p> <p><Header:> This option allows up to ten header lines which may exist in an ASCII file to be skipped. Select the number of header lines.</p>
2.	<p>CONF (F2) defines the format of the data to be imported.</p>
3.	<p>IMPORT Define ASCII Import</p> <p><Delimiter:> The separator between the import variables.</p> <p><Multi Spaces:> Available for <Delimiter: Space>. <Multi Spaces: No> for space delimited data having one space between the variables. <Multi Spaces: Yes> for space delimited data having multi spaces between the variables.</p>

Step	Description
	<p><No. Lines/Pt:> Available for <Delimiter: Line Feed>. The number of lines used to describe each point.</p> <p>Select the delimiter and the positions of the particular variables.</p>
	DEFLT (F5) recalls the default ASCII import settings.
4.	CONT (F1) leads back to IMPORT Import ASCII/GSI Data to Job
5.	SHIFT HTS (F2) to access IMPORT Define Ht Type & Easting Import .
6.	<p>IMPORT Define Ht Type & Easting Import</p> <p><Import as:> The height type for the imported data.</p> <p><Easting:> The Easting can be imported as written in the ASCII file or it can be multiplied by -1. This is required by some coordinate systems.</p>
7.	CONT (F1) leads back to IMPORT Import ASCII/GSI Data to Job
8.	CONT (F1) imports the data.
	Points with a height > 20000 m are not imported.
9.	<p>Information message: Are more data to be imported?</p> <ul style="list-style-type: none"> • If yes, continue with step 10. • If no, continue with step 11.
10.	YES (F6) . Repeat steps 1. to 9.
11.	NO (F4) returns to the GPS1200 Main Menu .

17.4

Importing Data in GSI Format

Requirements

At least one ASCII file in GSI format with the file extension *.gsi is stored in the \GSI directory of the CompactFlash card.

Access

Refer to "17.2 Accessing the Data Import Functionality" to access **IMPORT Import ASCII/GSI Data to Job**.

Import data step-by-step

Step	Description
1.	<p>IMPORT Import ASCII/GSI Data to Job</p> <p><Import: GSI Data></p> <p><From File:> All files with extension *.gsi in the \GSI directory on the Compact-Flash card can be selected.</p> <p><To Job:> Choosing a job as destination for import makes this job the active job. All jobs from Main Menu: Manage...\Jobs can be selected.</p>
	<p>CONF (F2) accesses IMPORT Define GSI Import. For <Switch WI81/WI82: Yes> all WI 81 data, normally Easting, is imported as Northing and all WI 82 data, normally Northing, is imported as Easting. This coordinate switch is necessary for "left handed" coordinate systems.</p>
2.	<p>SHIFT HTS (F2) to access IMPORT Define Ht Type & Easting Import.</p>
3.	<p>IMPORT Define Ht Type & Easting Import</p> <p><Import as:> The height type for the imported data.</p> <p><Easting:> The Easting can be imported as written in the *.gsi file or it can be multiplied by -1. This is required by some coordinate systems.</p>

Step	Description
4.	CONT (F1) leads back to IMPORT Import ASCII/GSI Data to Job
5.	CONT (F1) imports the data.
	Points with a height > 20000 m are not imported.
6.	Information message: Are more data to be imported? <ul style="list-style-type: none">• If yes, continue with step 7.• If no, continue with step 8.
7.	YES (F6) . Repeat steps 1. to 6.
8.	NO (F4) returns to the GPS1200 Main Menu .

17.5

Importing Data in DXF Format

Requirements

At least one file in DXF format with the file extension *.dxf has to be stored in the \DATA directory of the CompactFlash card.

Access

Refer to "17.2 Accessing the Data Import Functionality" to access **DXF IMPORT Import DXF Data to Job**.

Import data step-by-step

Step	Description
1.	<p>DXF IMPORT Import DXF Data to Job</p> <p><From File:> All files with extension *.dxf in the \DATA directory on the CompactFlash card can be selected.</p> <p><To Job:> Choosing a job as destination for import makes this job the active job. All jobs from Main Menu: Manage...Jobs can be selected.</p>
	<p>CONF (F2) accesses Configuration.</p> <p><Block Prefix:> Optional prefix to imported blocks.</p> <p><Point Prefix:> Optional prefix to imported points.</p> <p><Line Prefix:> Optional prefix to imported lines.</p> <p><File Units:> Choosing the unit for the DXF data to be imported.</p> <p><Create Vertex Points:> Option if points will be created at vertices of the imported line/arc/polyline elements.</p> <p><Convrt White Elements:> Option if white colored elements will be converted to black colored elements.</p>

Step	Description
	<Exclude Height:> Height value inside the DXF file are considered invalid and will not be converted.
2.	CONT (F1) leads back to DXF IMPORT Import DXF Data to Job
3.	CONT (F1) imports the data.
	Message: Do not remove CF Card!
4.	Information message: Are more data to be imported? If yes , continue with step 5. If no , continue with step 6.
5.	YES (F6) . Repeat steps 1. to 4.
6.	NO (F4) returns to the GPS1200 Main Menu .

18

Convert...\Copy Points Between Jobs

Description

This chapter explains the process of copying points from one job to another.

Important features:

- Points are copied as defined by the point filter settings.
- Points selected for copying may be viewed in a points listing. The point sort settings define the order of the points in the listing. The point filter settings define the points to be viewed in the listing.
- Only points are copied - observation data is not copied.
- When points are copied from one job to another:
 - their point codes and attached attributes are also copied.
 - their **Class** is retained.
 - their **Sub Class** is retained.
 - their **Source** is changed to **Copied Point**.
 - their **Point Coordinate Quality** is retained.
 - their **Instrument Flag** is retained.
 - their **Date and Time Stamp** is retained.

Access

Select **Main Menu: Convert...\Copy Points Between Jobs**.

COPY
Copy Points
Between Jobs

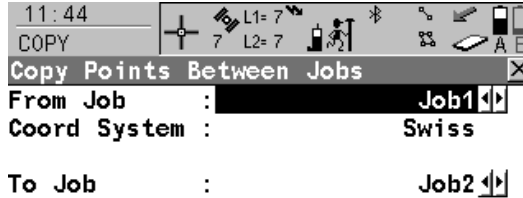

CONT (F1)

To copy a selection of points.

FILT (F4)

To define the point sort and/or point filter settings of points from the job **<From Job:>**.

DATA (F5)

To view, edit and delete points, lines and areas stored with the job. Points, lines and areas are shown on separate pages. Selected sort and filter settings apply. Refer to "9.3 Point Management".

CSYS (F6)

To select a different coordinate system.



Description of fields

Field	Option	Description
<From Job:>	Choicelist	Describes where the points are to be copied from. All jobs may be selected from Main Menu: Manage...\Jobs .
<Coord System:>	Output	The coordinate system which is currently attached to the job <From Job:> .
<To Job:>	Choicelist	Describes where the points are to be copied to. All jobs may be selected from Main Menu: Manage...\Jobs .

19 Config...\Survey Settings...

19.1 ID Templates

19.1.1 Overview

Description

ID templates are predefined templates for point, line or area numbers. ID templates save having to type in the ID for each object. They are useful when many points are collected quickly, for example in post-processed and real-time kinematic operations. The ID templates that are selected to be used suggest ID's for **<Point ID:>**, **<Line ID:>** and **<Area ID:>** when points, lines and areas are to be surveyed.

Default ID templates

Seven ID templates are implemented by default.

Default ID template	Description
0001	Suggested as ID for measured points in default configuration sets. This ID is automatically incremented.
Area0001	Suggested as ID for areas in default configuration sets. This ID is automatically incremented.
Auto0001	Suggested as ID for auto points in default configuration sets. These points are automatically recorded at a specific rate. This ID is automatically incremented.
Aux0001	Suggested as ID for auxiliary points in default configuration sets. These points are used when trying to find a stake-out point. This ID is automatically incremented.

Default ID template	Description
Line0001	Suggested as ID for lines in default configuration sets. This ID is automatically incremented.
No Template Used	The last point ID during a survey will be displayed. This ID is automatically incremented if it contains numerical characters. If this ID is overwritten, the auto increment starts from the new ID. The automatic incrementation can be turned off when editing this ID template. Refer to "19.1.4 Editing an ID Template".
Time & Date	The current local time and date is the ID.
Use Code&String	<p>Allows the line/area ID assigned to a line/area object to be based on the code related to the line/area.</p> <ul style="list-style-type: none"> • If line/area codes are being used then the line/area code is used as part of the line/area ID. • If point codes are being used then the point code is used as part of the line/area ID. • If attributes/strings are not being used then the numerical part of the line/area ID automatically increments.

19.1.2

Accessing ID Template Configuration

Access

Select **Main Menu: Config...\Survey Settings...ID Templates.**

OR

Press a hot key configured to access the screen **CONFIGURE ID Templates.** Refer to "6.1 Hot Keys" for information on hot keys.

OR

Press **USER.** Refer to "6.2 USER Key" for information on the **USER** key.

OR

Within the configuration set wizard. Refer to "14.2 Accessing Configuration Set Management".

CONFIGURE ID Templates

Field	Value
Survey Pts	0001
Auto Pts	Auto0001
Auxil Pts	Aux0001
Lines	Line0001
Areas	Area0001

CONT					Q1 a ↑
------	--	--	--	--	--------

CONT (F1)

To accept changes and return to the screen from where this screen was accessed.

Description of fields

Field	Option	Description
<Survey Pts:>	Choicelist	Sets the ID templates for manually occupied points.
<Auto Pts:>	Choicelist	Sets the ID templates for auto points. These points are automatically recorded at a specific rate.
<Auxil Pts:>	Choicelist	Sets the ID templates for auxiliary points. These points are used when trying to find a stake-out point.
<Lines:>	Choicelist	Sets the ID templates for lines.
<Areas:>	Choicelist	Sets the ID templates for areas.

Next step

IF an ID template	THEN
is to be selected	select the desired ID template. CONT (F1) to close the screen and to return to the screen from where CONFIGURE ID Templates was accessed.
is to be created	Refer to "19.1.3 Creating a New ID Template".
is to be edited	Refer to "19.1.4 Editing an ID Template".
is to be deleted	Refer to "19.1.5 Deleting an ID Template".

19.1.3

Creating a New ID Template

Create ID template step-by-step

Step	Description
1.	Refer to "19.1.2 Accessing ID Template Configuration" to access CONFIGURE ID Templates .
2.	In CONFIGURE ID Templates highlight any field.
3.	ENTER to access CONFIGURE ID Template Library .
4.	Highlight an ID template. A copy of this ID template is taken for further configurations.
5.	NEW (F2) to access CONFIGURE New ID Template .
6.	<p>CONFIGURE New ID Template</p> <p><ID:> The name of the ID template and the format of the ID object. Any characters including spaces are allowed. Leading spaces are not accepted.</p> <p><Increment:> ID's are incremented numerical or alphanumerical.</p> <p><Increment By:> The amount by which the point ID is incremented.</p> <p><Cursor Posn:> The character position at which the cursor is placed when ENTER is pressed in <Point ID:> when surveying points. <Cursor Posn: Last Character> means that the cursor is placed immediately to the right of the last character.</p> <p>Adapt the settings according to the requirements.</p>
7.	CONT (F1) stores the new ID template into the ID template library and returns to CONFIGURE ID Template Library .
8.	CONT (F1) returns to CONFIGURE ID Templates .

Step	Description
9.	CONT (F1) returns to the screen from where CONFIGURE ID Templates was accessed.

Examples for incrementation

For <Increment: Numeric only>

The rightmost numeric part is incremented within the point ID.

<ID:>	<Increment By:>	Next point ID	Notes
Point994	5	Point999 Point1004 ...	-
994point	5	999point 1004point ...	-
123point123	-10	123point113	Right hand side numbers are incremented. Negative increments allowed.
Point11	-6	Point5 Point-1 Point-7 Point-13 ...	-
Abcdefghijklmn94	5	Abcdefghijklmno99 Point ID increment fail	Incrementation fails if next increment will result in more than 16 characters.

<ID:>	<Increment By:>	Next point ID	Notes
Abcdefghijklmno9	-5	Abcdefghijklmnop4 Point ID increment fail	Negative incrementing fails if next increment requires negative sign and will result in more than 16 characters.

For <Increment: Alphanumeric>

The rightmost character within the point ID is incremented regardless of whether that character is numeric or alphanumeric.

Template	Increment value	Next point ID's	Notes
Point994	5	Point999 Point99E Point99J ...	-
994point	5	994poiny Point ID increment fail	Lower case alpha characters increment until z is reached. Then a new point ID must be entered.
Abcdef	-5	Abcdea AbcdeV ... AbcdeB Point ID increment fail	Lower case alpha characters decrement from lower to upper case until A is reached. Then a new point ID must be entered.

Template	Increment value	Next point ID's	Notes
ABCDEB	5	ABCDEB ABCDEG ... Abcdez Point ID increment fail	Upper case alpha characters increment from upper to lower case until z is reached. Then a new point ID must be entered.

19.1.4

Editing an ID Template

Edit ID template step-by-step

Step	Description
1.	Refer to "19.1.2 Accessing ID Template Configuration" to access CONFIGURE ID Templates .
2.	In CONFIGURE ID Templates highlight any field.
3.	ENTER to access CONFIGURE ID Template Library .
4.	CONFIGURE ID Template Library Highlight the ID template to be edited. The ID template Time & Date cannot be edited. EDIT (F3) .
5.	CONFIGURE Edit ID Template The type of ID template selected for editing determines the availability of the fields on this screen. <ul style="list-style-type: none"> Available for the default ID template No Template Used: <ID:> The name of the ID template cannot be changed since it is a default ID template. The other fields on this screen are the same as in CONFIGURE New ID Template. Refer to "19.1.3 Creating a New ID Template". Available for a user defined ID template: All fields on this screen are the same as in CONFIGURE New ID Template. Refer to "19.1.3 Creating a New ID Template". Adapt the settings according to the requirements.
6.	CONT (F1) stores the changes and returns to CONFIGURE ID Template Library .

Step	Description
7.	CONT (F1) returns to CONFIGURE ID Templates .
8.	CONT (F1) returns to the screen from where CONFIGURE ID Templates was accessed.

19.1.5

Deleting an ID Template

Delete ID template step-by-step

Step	Description
1.	Refer to "19.1.2 Accessing ID Template Configuration" to access CONFIGURE ID Templates .
2.	In CONFIGURE ID Templates highlight any field.
3.	ENTER
4.	CONFIGURE ID Template Library Highlight the ID template to be deleted. DEL (F4)
	It does not matter if the ID template is being used in a configuration set. The ID template will be rebuilt when that configuration set becomes active.
5.	YES (F4) returns to the CONFIGURE ID Template Library .
6.	CONT (F1) returns to CONFIGURE ID Templates .
7.	CONT (F1) returns to the screen from where CONFIGURE ID Templates was accessed.

19.1.6

Working Example

Description

- Application:
- Pick up points with many different point ID's.
 - Most point ID's require an incrementing number behind a text.

Working technique: Real-time kinematic.

- Goal:
- The first point ID's for survey points are Bolt 001, Bolt 002,
 - A different point ID can be entered manually during the survey.
 - The following point ID's will be based on the manually entered point ID.
 - An individual point ID can be typed in for one point.

Requirements

- A real-time reference is running.
- For the rover: **<R-Time Mode: Rover>** in **CONFIGURE Real-Time Mode**.

Configuration of ID template step-by-step

Step	Description
1.	Refer to "19.1.3 Creating a New ID Template". Follow step 1. to 4.
2.	CONFIGURE New ID Template <ID: Bolt 001> <Increment: Numeric only> <Increment By: 1> <Cursor Posn: 1>
3.	CONT (F1) closes the screen and returns to CONFIGURE ID Template Library .

Step	Description
4.	CONT (F1) returns to CONFIGURE ID Templates .
5.	CONFIGURE ID Templates <Survey Pts: Bolt 001>
6.	CONT (F1) returns to the screen from where CONFIGURE ID Templates was accessed.

Field procedure step-by-step

Step	Description
1.	Refer to "44.3 Surveying Points" to access SURVEY Survey: Job Name .
2.	SURVEY Survey: Job Name <Point ID: Bolt 001> is shown automatically. At the point to be measured, place and level the pole on the point.
3.	OCUPY (F1)
4.	STOP (F1)
5.	STORE (F1) <Point ID: Bolt 002> is shown automatically.
6.	Repeat steps 2. to 4. until all points with the ID Bolt XXX are surveyed.
7.	SURVEY Survey: Job Name The next point ID's are RoadXXXX, starting with Road0723. Type Road0723. <Point ID: Road0723>.
8.	OCUPY (F1)

Step	Description
9.	STOP (F1)
10.	STORE (F1) <Point ID: Road0724> is shown automatically.
11.	Repeat steps 7. to 9. until all points with the ID RoadXXXX are surveyed.
12.	SURVEY Survey: Job Name The next required point ID is BM98. It is valid for one point. SHIFT INDIV (F5)
13.	SURVEY Survey: Job Name Type BM98. <Indiv Pt ID: BM98>.
14.	OCUPY (F1)
15.	STOP (F1)
16.	STORE (F1) The system changes back to use the ID template RoadXXXX.

19.2

Display Settings

Description

Display settings define the parameters shown on a page on the **SURVEY** screen.

Four display masks are definable.

Mask 1: Always shown on the **SURVEY** screen.

Mask 2: Can be shown or hidden on the **SURVEY** screen.

Mask 3: Can be shown or hidden on the **SURVEY** screen.

Mask 4: Never shown on the **SURVEY** screen. Reserved for application programs.

The settings on this screen define the layout of the four display masks.

Access

Select **Main Menu: Config...\Survey Settings...\Display Settings**.

OR

Press a hot key configured to access the screen **CONFIGURE Display Settings**. Refer to "6.1 Hot Keys" for information on hot keys.

OR

Press **USER**. Refer to "6.2 USER Key" for information on the **USER** key.

OR

Within the configuration set wizard. Refer to "14.2 Accessing Configuration Set Management".

CONFIGURE Display Settings

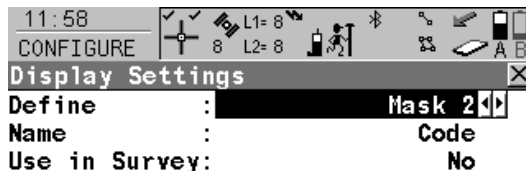

Position and
Screen Update: 0.2s



CONT (F1)

To accept changes and return to the screen from where this screen was accessed.

DMASK (F3)

To configure the selected display mask. Refer to paragraph "CONFIGURE Define Display Mask n".

Description of fields

Field	Option	Description
<Define:>	Mask 1, 2, 3 or 4	Selected display mask.
<Use in Survey:>	Output	Indicates if the display mask is shown or hidden as a page in SURVEY .
<Position and Screen Update:>	From 0.05s to 1.0s	Determines how often positions are computed and the screen display is updated. The maximum update rate using Bluetooth on RX1250 is 0.2 s.

Next step

IF a display mask	THEN
is not to be edited	CONT (F1) closes the screen and returns to the screen from where CONFIGURE Display Settings was accessed.
is to be edited	highlight the display mask and DMASK (F3) . Refer to paragraph "CONFIGURE Define Display Mask n".

**CONFIGURE
Define Display Mask n**

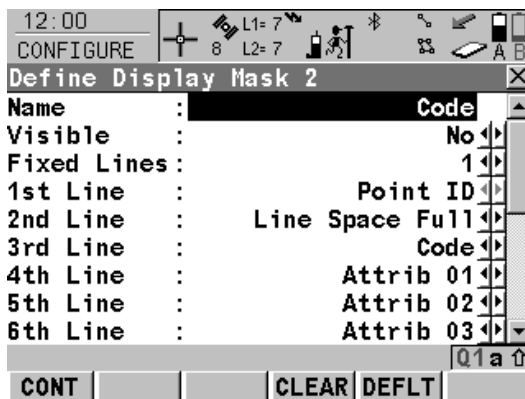

- CONT (F1)**
To accept changes and to return to **CONFIGURE Display Settings**.
- CLEAR (F4)**
To set all fields to <XX. Line: Line Space Full>.
- DEFLT (F5)**
To recall the default settings.

Description of fields

Field	Option	Description
<Visible:>	Yes or No	Shows or hides the display mask as a page in SURVEY .

Field	Option	Description
<Fixed Lines:>	From 0 to 5	Defines how many lines do not scroll in the survey screen when that display mask is used.
<1st Line:>	Output	Fixed to <1st Line: Point ID>.
<2nd Line:> to <16th Line:>	<p>% Completed</p> <p>Annot 1-4</p> <p>Antenna Ht</p> <p>Atmos Pressure</p> <p>Attrib (free) 01-20</p> <p>Attrib 01-20</p> <p>Code</p> <p>Code (free)</p> <p>Code Desc</p> <p>Code Desc (free)</p> <p>Code Type</p>	<p>For each line one of the following options can be selected.</p> <p>Output field for the percentage of the time for which the point has been occupied based on the setting for <STOP Criteria:> in screen CONFIGURE Point Occupation Settings. Appears in the display mask during the point occupation unless <STOP Criteria: None> or <% Indicator: None>.</p> <p>Input field for comments to be stored with the point.</p> <p>Input field for antenna height for static observations.</p> <p>Input field for atmospheric pressure.</p> <p>Output field for attributes for free codes.</p> <p>Input field for attributes for codes.</p> <p>Input field for codes.</p> <p>Input field for free codes.</p> <p>Output field for the description of codes.</p> <p>Output field for the description of free codes.</p> <p>Output field for the type of code, for example point code, line code or area code.</p>

Field	Option	Description
	GDOP	Output field for the current GDOP of the computed position.
	HDOP	Output field for the current HDOP of the computed position.
	Line Space Full	Insert full line space.
	Line Space Half	Insert half line space.
	Linework	Choicelist with option for flagging a line/area. Refer to "19.3 Coding & Linework".
	Moving Ant Ht	Input field for antenna height for moving observations.
	Msd PP Obs	Output field for the number of static observations recorded over the period of point occupation. Appears in the display mask when recording of static observations is configured.
	PDOP	Output field for the current PDOP of the computed position.
	Point ID	Input field for the point number.
	Quality 1D	Output field for the current height coordinate quality of computed position.
	Quality 2D	Output field for the current 2D coordinate quality of computed position.
	Quality 3D	Output field for the current 3D coordinate quality of computed position.

Field	Option	Description
	RTK Positions	Output field for the number of positions recorded over the period of point occupation. Appears in the display mask of real-time rover configurations.
	Rel Humidity	Input field for relative humidity to be stored with point.
	Temp Dry	Input field for dry temperature to be stored with point.
	Temp Wet	Input field for wet temperature to be stored with point.
	Time at Point	Output field for the time from when the point is occupied until point occupation is stopped. Appears in the display mask during the point occupation.
	VDOP	Output field for the current VDOP of the computed position.

Next step

Step	Description
1.	CONT (F1) returns to CONFIGURE Display Settings .
2.	CONT (F1) returns to the screen from where CONFIGURE Display Settings was accessed.

19.3

Coding & Linework

Description

The settings on this screen define the method of coding. Refer to "11 Coding" for a complete description of coding.

Access

Select **Main Menu: Config...\Survey Settings...\Coding & Linework Settings.**

OR

Press a hot key configured to access the screen **CONFIGURE Coding & Linework.**
Refer to "6.1 Hot Keys" for information on hot keys.

OR

Press **USER.** Refer to "6.2 USER Key" for information on the **USER** key.

OR

Within the configuration set wizard. Refer to "14.2 Accessing Configuration Set Management".

CONFIGURE
Coding & Linework,
Coding page

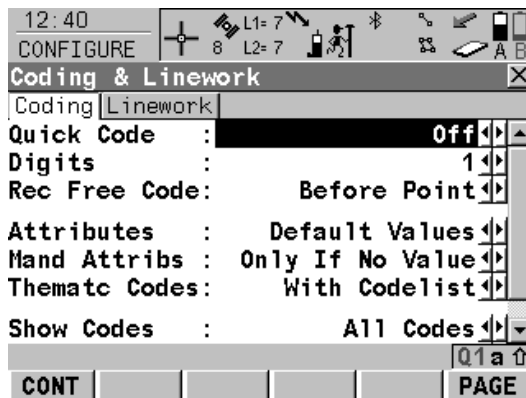
**CONT (F1)**

To accept changes and return to the screen from where this screen was accessed.

PAGE (F6)

To change to another page on this screen.

Description of fields

Field	Option	Description
<Quick Code:>	Never On Off	<p>Prevents the use of quick coding completely.</p> <p>Allows the use of quick coding and activates it.</p> <p>Allows the use of quick coding, but keeps it deactivated.</p>
<Digits:>	1, 2 or 3	<p>Available unless <Quick Code: Never>.</p> <p>Sets the mostly used number of digits for the quick code. Quick codes with less digits can still be used. While typing a quick code during a survey, using ENTER after typing one or two digits of the quick code indicates the end of the input.</p>
<Rec Free Code:>	After Point or Before Point	<p>Available unless <Quick Code: Never>.</p> <p>Determines if a free code measured with a quick code is stored before or after the point.</p>
<Attributes:>	Default Values Last Used	<p>Determines the attribute values displayed under certain circumstances. This is applicable to both the storing and displaying of attribute values.</p> <p>When available, the default attribute values, as stored in the job, are displayed and stored.</p> <p>When available, the last used attribute values as stored in the job are displayed and stored.</p>

Field	Option	Description
<Mand Attribs:>	Always Prompt	The screen XX Enter Mandatory Attribute will always appear when codes, having one or more attributes of attribute type mandatory, are being stored. Attributes of attribute type mandatory or fixed can only be created in LGO.
	Only If No Value	The screen XX Enter Mandatory Attribute will only appear when codes, having one or more attributes of attribute type mandatory, are being stored without an attribute value. Attributes of attribute type mandatory must always be created in LGO.
	Code Change Only	The screen XX Enter Mandatory Attribute will only appear when a new code with a mandatory attribute was selected.
<Themac Codes:>	With Codelist	Sets the coding method. Codes stored within the job codelist can be selected to code points, lines and areas.
	Without Codelist	Codes stored within the job codelist cannot be selected to code points, lines and areas. Each code must be entered manually.
<Show Codes:>	Only Pt Codes	Only point codes will be available in the choicelist for <Code:>/<Point Code:> in a display mask of an application program.

Field	Option	Description
	All Codes	All codes of the job codelist will be available in the choicelist for <Code:>/<Point Code:> in a display mask of an application program. Selecting a line/area code opens a new line/area.
<String Attrib:>	Choicelist	Available for <Show Codes: All Codes> . When this field is active, surveyed points that have the same code attached are strung to one line.

Next step

PAGE (F1) changes to the **Linework** page. Refer to paragraph "CONFIGURE Coding & Linework, Linework page".

CONFIGURE Coding & Linework, Linework page

The flags for Linework are defined on this screen. A flag

- is stored as a property of a point.
- can be exported with a format file.
- is different to a code.

The flags defined on this screen are linked to the options available for **<Linework:>** in a display mask of an application program. The selection for **<Linework:>** in a display mask determines the flag stored with a point. The availability of **<Linework:>** in a display mask is configured in **CONFIGURE Define Display Mask n**. Refer to "12 Linework" for information on Linework.

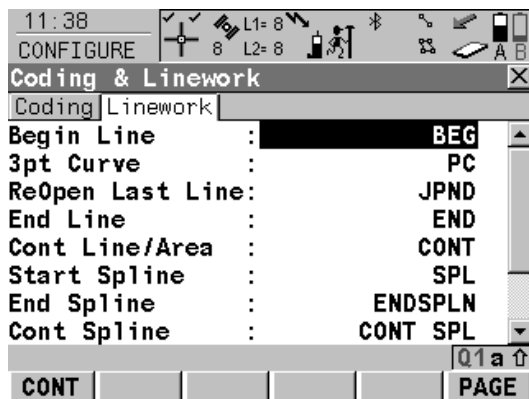
**CONT (F1)**

To accept changes and return to the screen from where this screen was accessed.

PAGE (F6)

To change to another page on this screen.

Description of fields

Field	Option	Description
<Begin Line:>	User input	Opens a new line when the next point is stored. Any lines which are currently open are closed. The point may or may not be stored with a point code.
<3pt Curve:>	User input	Stores the linework flag for a curve through the next three measured points and continues a line/area.
<ReOpen Last Line:>	User input	Opens the last used line again.
<End Line:>	User input	Closes all open lines.
<Cont Line/Area:>	User input	Indicates a line/area is open.

Field	Option	Description
<Start Spline:>	User input	Stores the linework flag for beginning a spline and continues any open line/area.
<End Spline:>	User input	Stores the linework flag to stop a spline.
<Cont Spline:>	User input	Indicates a line/area is open with spline line type.
<Begin Area:>	User input	Opens a new area when the next point is stored. Any areas which are currently open are closed. The point may or may not be stored with a point code.
<ReOpen Last Area:>	User input	Opens the last used area again.
<Close Area:>	User input	Closes all open areas.

Next step

PAGE (F6) changes to the first page on this screen.

19.4 Quality Control Settings

Description

The settings on this screen define the limits for coordinate quality and DOP values accepted for point occupations.

Access

Select **Main Menu: Config...\Survey Settings...\Quality Control Settings**.

OR

Press a hot key configured to access the screen **CONFIGURE Quality Control Settings**. Refer to "6.1 Hot Keys" for information on hot keys.

OR

Press **USER**. Refer to "6.2 USER Key" for information on the **USER** key.

OR

Within the configuration set wizard. Refer to "14.2 Accessing Configuration Set Management".

CONFIGURE Quality Control Settings

11:40

CONFIGURE

Quality Control Settings

CQ Control : Pos & Height

Maximum CQ : 0.050 m

DOP Limit : GDOP

Maximum DOP : 20.0

Allow 2D Posn: Yes

CONT Q1 a ↑

CONT (F1)

To accept changes and return to the screen from where this screen was accessed.

Description of fields

Field	Option	Description
<CQ Control:>	None, Pos Only, Height Only or Pos & Height	The type of coordinate quality to be checked before storing a point. If activated, the limit defined in <Maximum CQ:> is checked before storing a point. A warning signal is given when the limit is exceeded. Refer to "9.3.1 Terminology" for information on coordinate quality.
<Maximum CQ:>	User input	Available unless <CQ Control: None>. The maximum acceptable coordinate quality.
<DOP Limit:>	None, GDOP, PDOP, HDOP or VDOP	If activated, the limit defined in <Maximum DOP:> is checked. GPS positions are unavailable when the limit is exceeded.
<Maximum DOP:>	User input	Available unless <DOP Limit: None>. The maximum acceptable DOP value.
<Allow 2D Posn:>	Yes No	2D positions can be obtained with only three satellites available. The height is fixed to that of the last position computed with height. 2D positions cannot be obtained with only three satellites available.

Next step

CONT (F1) returns to the screen from where **CONFIGURE Quality Control Settings** was accessed.

19.5

Logging of Raw Obs

Description

Logged raw observations are used for

- static and kinematic operations. With these operations, raw data is always post-processed in the office. Raw data must therefore be logged on both reference and rover receivers.
- real-time operations
to check the work in the office by post-processing.

OR

to fill in gaps when a real-time position could not be calculated in the field. This can happen due to problems with the real-time data reception.

Observations must be logged on all receivers which will be used for post-processing.

The settings on this screen define the logging of raw observations.

Access

This menu option is licence protected and is only activated through a licence key. The licence key can only be loaded from the CompactFlash card.

Select **Main Menu: Config...\Survey Settings...\Logging of Raw Obs.**

OR

Press a hot key configured to access the screen **CONFIGURE Logging of Raw Obs.**
Refer to "6.1 Hot Keys" for information on hot keys.

OR

Press **USER**. Refer to "6.2 USER Key" for information on the **USER** key.

OR

Within the configuration set wizard. Refer to "14.2 Accessing Configuration Set Management".

CONFIGURE
Logging of Raw Obs

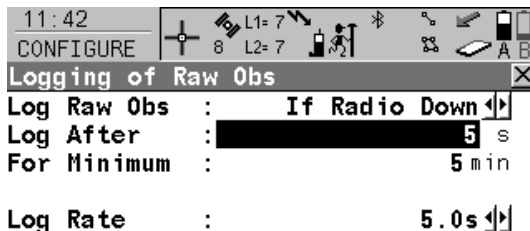

CONT (F1)



To accept changes and return to the screen from where this screen was accessed.

Description of fields

Field	Option	Description
<Log Raw Obs:>	Never	Available unless <R-Time Mode: Reference>. No raw observation logging during either static or moving intervals.
	Static Only	Available unless <R-Time Mode: Reference>. Raw observation logging during static intervals when occupying a point. The receiver has to be stationary.

Field	Option	Description
	Static & Moving If Radio Down Yes No	<p>Available unless <R-Time Mode: Reference>. Raw observation logging during static and moving intervals. For post-processed kinematic rover operations.</p> <p>Available for <R-Time Mode: Rover>. Continuous raw observation logging during static and moving intervals when no real-time corrections are being received by a receiver.</p> <p>Available for <R-Time Mode: Reference>. Raw observation logging.</p> <p>Available for <R-Time Mode: Reference>. No raw observation logging.</p>
<Log After:>	User input	Available for <Log Raw Obs: If Radio Down> . Raw data logging begins after the specified time if radio contact is lost.
<For Minimum:>	User input	Available for <Log Raw Obs: If Radio Down> . Raw data logging continues for the specified time, also after the radio link is regained.
<Log Rate:>	From 0.05s to 300.0s	<p>Available unless <Log Raw Obs: Never> or <Log Raw Obs: No>. Rate at which raw observations are logged.</p> <p>Recommendations:</p> <ul style="list-style-type: none"> The maximum logging rate using Bluetooth on RX1250 is 0.2 s.

Field	Option	Description
		<ul style="list-style-type: none"> • For static operations with long baselines and over long time <Log Rate: 15.0s> or <Log Rate: 30.0s>. • For reference stations for post-processed and real-time kinematic rovers, <Log Rate:> at the reference should be the same rate as at the rover. • For initialisation while static and occupying distinct points in kinematic chains <Log Rate: > between 0.1s and 2.0s.

Next step

IF files for raw observations	THEN
are not to be configured	CONT (F1) closes the screen and returns to the screen from where CONFIGURE Logging of Raw Obs was accessed.
are to be configured	FILES (F6) . Refer to paragraph "CONFIGURE Raw Observation Files".

CONFIGURE Raw Observation Files

11:44

CONFIGURE

Raw Observation Files

Use Separate Files: **Yes**

Obs File Size : 10 mins

Split Tracks : No

Delete Old Files : Yes

When Older Than : 7 days

CONT (F1)

To accept changes and to return to
CONFIGURE Logging of Raw Obs.

Q1a ↑

CONT

Description of fields

Field	Option	Description
<Use Separate Files:>	Yes or No	Stores all raw observations into one or into separate files.
<Obs File Size:>	From 1 min to 24 hours	Available for <Use Separate Files: Yes>. Splits the recorded data up into files of a specific period of time.
<Split Tracks:>	Yes or No	Available for <Use Separate Files: Yes> and unless <R-Time Mode: Reference>. Activates the interruption of static intervals when the time set for <Obs File Size:> is reached. The data is then recorded to a new file.

Field	Option	Description
		Moving intervals are always interrupted and written to a new file when the time set for <Obs File Size:> is reached.
<Delete Old Files:>	Yes or No	Available for <Use Separate Files: Yes> . Deletes the recorded data after a specified period of time.
<When Older Than:>	From 1 day to 30 days	Available for <Delete Old Files: Yes> . The period of time after which the recorded data is deleted.

Next step

Step	Description
1.	CONT (F1) returns to CONFIGURE Logging of Raw Obs.
2.	CONT (F1) returns to the screen from where CONFIGURE Logging of Raw Obs was accessed.

19.6

19.6.1

Point Occupation Settings

Configuration of Point Occupation Settings

Description

The settings on this screen define the way in which points are occupied and recorded.



Point occupation settings are configurable for **<R-Time Mode: Rover>** and **<R-Time Mode: None>**.

Access

Select **Main Menu: Config...\Survey Settings...\Point Occupation Settings**.

OR

Press a hot key configured to access the screen **CONFIGURE Point Occupation Settings**. Refer to "6.1 Hot Keys" for information on hot keys.

OR

Press **USER**. Refer to "6.2 USER Key" for information on the **USER** key.

OR

Within the configuration set wizard. Refer to "14.2 Accessing Configuration Set Management".

CONFIGURE
Point Occupation
Settings

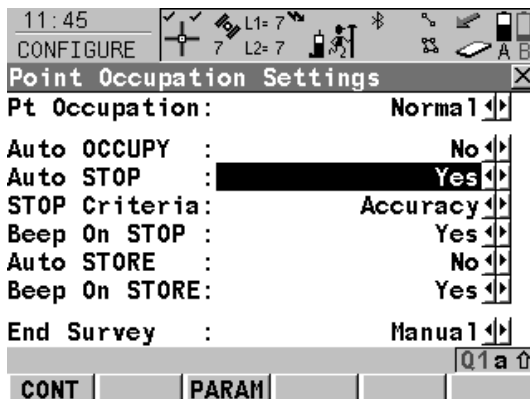

CONT (F1)

To accept changes and return to the screen from where this screen was accessed.

PARAM (F3)

To configure the time interval after which a point occupation can be stopped automatically. Refer to paragraph "CONFIGURE Post-Process Stop Criteria".

Description of fields

Field	Option	Description
<Pt Occupation:>	Normal	The way in which coordinates for a point are recorded. Records observations between pressing OCCUPY (F1) and STOP (F1) . Recommended for static post-processed reference station and normal real-time applications.

Field	Option	Description
	Instantaneous	Records the time tag when OCCUPY (F1) is pressed. A coordinate is interpolated between the positions at the neighbouring two epochs to filter out effects of slight movement. Recommended when measuring positions of objects while the antenna is moving. Example: Measuring the position of lampposts by driving in a car along the road and pressing OCCUPY (F1) when the car is next to the lamppost. Refer to the diagram below.
<Auto OCCUPY:>	No Yes Timed	Available for <Pt Occupation: Normal> . Starts point occupation when pressing OCCUPY (F1) . Starts point occupation automatically when entering SURVEY Survey: Job Name . All subsequent points must be occupied by pressing OCCUPY (F1) . Starts point occupation automatically at a certain time. The start time is specified in SURVEY Survey: Job Name .
<Auto STOP:>	Yes or No	Available for <Pt Occupation: Normal> . Stops the measurements automatically when the parameter defined for <STOP Criteria:> reaches 100 %.
<STOP Criteria:>		Available for <Pt Occupation: Normal> and <Auto STOP: Yes> .

Field	Option	Description
	<p>Accuracy or Positions</p> <p>Time, Observations or No. of Satellites</p>	<p>Defines the method used for <Auto STOP:>. The setting determines the computation and value to be shown for <% Completed:> in the display mask and in STATUS Occupation Information. Parameters for the selected method are defined with PARAM (F3). Refer to paragraph "CONFIGURE Post-Process Stop Criteria" or "CONFIGURE Real-Time Stop Criteria".</p> <p>Available for <R-Time Mode: Rover>.</p> <p>Available for <R-Time Mode: None>.</p>
<% Indicator:>	None or Positions	<p>Available for <Pt Occupation: Normal> and <Auto STOP: No>.</p> <p>The setting determines the computation and value to be shown for <% Completed:> in the display mask and in STATUS Occupation Information. This is an indicator when to stop the point occupation. Parameters for the selected method are defined with PARAM(F3). Refer to paragraph "CONFIGURE Post-Process Stop Criteria" or "CONFIGURE Real-Time Stop Criteria".</p> <p>Available for <R-Time Mode: Rover>.</p>

Field	Option	Description
	None, Time, Observations or No. of Satellites	Available for <R-Time Mode: None> .
<Beep On STOP:>	Yes or No	Activates that a beep is made when the point occupation is ended by <Auto STOP:> .
<Auto STORE:>	Yes or No	Stores points automatically after stopping the point occupation.
<Beep On STORE:>	Yes or No	Activates that a beep is made when the point is stored by <Auto STORE:> .
<End Survey:>	Manual Automatically Auto & Turn Off	Available for <Pt Occupation: Normal> . Defines the instrument behaviour once a point is stored. Manual Exits SURVEY when pressing ESC . Automatically Exits SURVEY automatically when pressing STORE (F1) and returns to main menu. Auto & Turn Off Exits SURVEY automatically when pressing STORE (F1) and turns receiver off.

Point occupation mode Normal

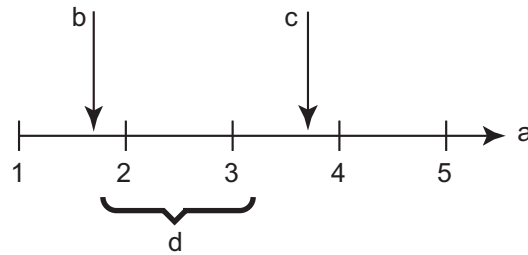

GPS12_056

- a) Time in epochs
- b) **OCUPY (F1)** pressed
- c) **STOP (F1)** pressed
- d) Post-processed coordinates computed by averaging resulting positions of epochs 2 and 3

Point occupation mode Instantaneous

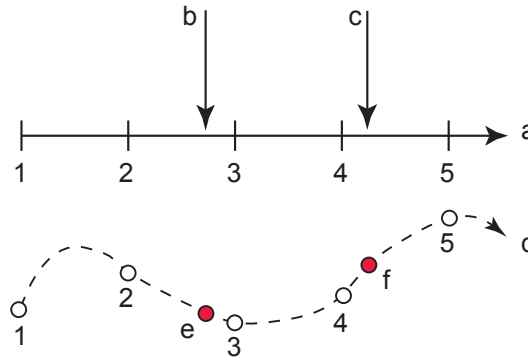

GPS12_057

- a) Time in epochs
- b) **OCUPY (F1)** pressed and point coordinates interpolated based on epochs 2 and 3
- c) **OCUPY (F1)** pressed and point coordinates interpolated based on epochs 4 and 5
- d) Plan view
- e) **OCUPY (F1)** pressed and point coordinates interpolated based on epochs 2 and 3
- f) **OCUPY (F1)** pressed and point coordinates interpolated based on epochs 4 and 5

Next step

IF parameters for <Auto STOP:>	AND	THEN
are not to be configured	-	CONT (F1) closes the screen and returns to the screen from where CONFIGURE Point Occupation Settings was accessed.
are to be configured	< R-Time Mode: None >	PARAM (F3) changes to CONFIGURE Post-Process Stop Criteria . Refer to paragraph "CONFIGURE Post-Process Stop Criteria".
are to be configured	< R-Time Mode: Rover >	PARAM (F3) changes to CONFIGURE Real-Time Stop Criteria . Refer to paragraph "CONFIGURE Real-Time Stop Criteria".

CONFIGURE
Post-Process Stop
Criteria

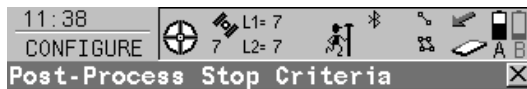

Auto STOP/%Indicator based on

Time at Point : **3.0** min

CONT (F1)

To accept changes and to return to
CONFIGURE Point Occupation
Settings.



Description of fields

The parameters shown on this screen depend on the setting for **<STOP Criteria:>** in **CONFIGURE Point Occupation Settings.**

Field	Option	Description
<Time at Point:>	User input	Sets the required observation time for each point. Counting time starts when OCUPY (F1) is pressed. The receiver stops measuring when the set length of time is reached.
<Number of Obs:>	User input	Sets the required number of observations that should be recorded at each point. Counting observations starts when OCUPY (F1) is pressed. The receiver stops measuring when the set number of observations is reached.

Field	Option	Description
<At Logging Rate:>	Output	Displays the rate at which static raw observations are logged as configured in CONFIGURE Logging of Raw Obs.
<8+ satellites for:> <7 satellites for:> <6 satellites for:> <5 satellites for:> <4 satellites for:>	User input	<p>Sets the required observation time depending on the number of satellites available. Counting time starts when OCUPY (F1) is pressed. The receiver stops measuring when the set length of time for a certain number of satellites is reached.</p> <p>Should the number of available satellites change during observation, the observations already recorded will be taken into account. Refer to paragraph "Observation time depending on the number of satellites available".</p>

Next step

Step	Description
1.	CONT (F1) closes the screen.
2.	CONT (F1) returns to the screen from where CONFIGURE Point Occupation Settings was accessed.

CONFIGURE
Real-Time Stop Criteria

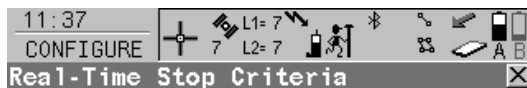

Auto STOP/%Indicator based on

Pos Quality < : **0.0200** m
Ht Quality < : 0.0200 m

For a min number of positions

Positions : 5
Position Update : 1.00 s



CONT (F1)

To accept changes and to return to
CONFIGURE Point Occupation Settings.

Description of fields

The parameters shown on this screen depend on the setting for <STOP Criteria:> in **CONFIGURE Point Occupation Settings.**

Field	Option	Description
<Pos Quality <:> and <Ht Quality <:>	User input	Sets the maximum position and height qualities for each point occupation. Calculating the qualities starts when OCUPY (F1) is pressed. The receiver stops measuring when the position and height qualities are both less than the configured values.
<Positions:>	User input	Raw data is logged for a minimum number of positions even when the <Pos Quality <:> and <Ht Quality <:> is already less than the specified maximum.

Field	Option	Description
<Position Update:>	Output	Displays the value for <Position and Screen Update:> as configured in CONFIGURE Display Settings .
<No. of Positions:>	User input	Sets the number the positions which must be observed before the receiver stops measuring. Counting the number of positions starts when OCUPY (F1) is pressed.

Next step

Step	Description
1.	CONT (F1) returns to CONFIGURE Point Occupation Settings .
2.	CONT (F1) returns to the screen from where CONFIGURE Point Occupation Settings was accessed.

Observation time
depending on the
number of satellites
available

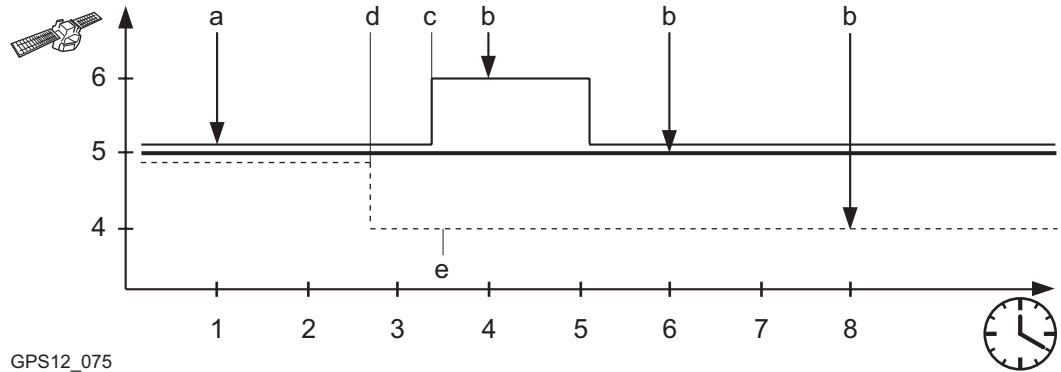

GPS12_075

Thin line represents **<6 satellites for: 3 min>**.

Bold line represents **<5 satellites for: 5 min>**.

Dashed line represents **<4 satellites for: 7 min>**.

- a) **OCUPY (F1)** is pressed. Counting time starts.
- b) Observation is stopped.
- c) 40 % for five satellites
- d) 30 % for five satellites
- e) 30 % for four satellites

19.6.2

Working Example

Description

Application:

- Surveying individual points in a kinematic chain.
- Required accuracy less than 30 mm.

Working technique:

Real-time kinematic

Aim:

- Press **OCCUPY (F1)** to start recording manually.
- Stop recording and storing points without user interaction.
- After storing, the instrument stays in the **SURVEY** screen.

Requirements



<R-Time Mode: Rover> in **CONFIGURE Real-Time Mode**.

Configuration of point occupation settings step-by-step

Step	Description
1.	Refer to "19.6.1 Configuration of Point Occupation Settings" for accessing CONFIGURE Point Occupation Settings .
2.	CONFIGURE Point Occupation Settings <Pt Occupation: Normal> <Auto OCCUPY: No> <Auto STOP: Yes> <STOP Criteria: Positions> <Auto STORE: Yes> <End Survey: Manual>
3.	PARAM (F3)

Step	Description
4.	CONFIGURE Post-Process Stop Criteria Type in how many positions are to be occupied before the point occupation stops automatically. The number varies with each application.
5.	CONT (F1) closes the screen.
6.	CONT (F1) returns to the screen from where CONFIGURE Point Occupation Settings was accessed.

Field procedure step-by-step

Step	Description
1.	Refer to "44.3 Surveying Points" for accessing SURVEY Survey: Job Name .
2.	At the point to be measured, place and level the pole on the point.
3.	Enter a point ID.
4.	If required, type in the antenna height.
5.	If required, type in a code.
	Point ID, antenna height and code must be correctly typed in before OCUPY (F1) is pressed due to <Auto STORE: Yes> .
6.	OCUPY (F1)
	The point will be recorded and stored automatically as soon as the set number of observations are recorded.
7.	Move to the next point.
8.	Repeat steps 2. to 7. until all points are measured.

19.7

Seismic Recording

Description

In some countries, certain information must be documented for seismic surveys. This information is output as a seismic record. Refer to "Appendix H Seismic Record Format" for a detailed description of the seismic record format.

The settings on this screen activate seismic recording.

Access

Select **Main Menu: Config...\Survey Settings...\Seismic Recording**.

OR

Press a hot key configured to access the screen **CONFIGURE Seismic Recording**. Refer to "6.1 Hot Keys" for information on hot keys.

OR

Press **USER**. Refer to "6.2 USER Key" for information on the **USER** key.

OR

Within the configuration set wizard. Refer to "14.2 Accessing Configuration Set Management".

CONFIGURE
Seismic Recording

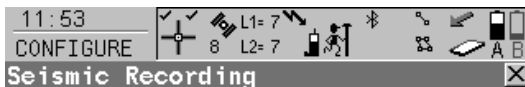

Store Seismic Record: Yes



CONT (F1)

To accept changes and return to the screen from where this screen was accessed.

Description of fields

Field	Option	Description
<Store Seismic Record:>	Yes or No	<p>Stores a seismic record with each real-time point. The seismic record is stored in point annotation 4 of a point.</p> <p> For auto logged points set additionally <Store: DBX(Pnts&Codes)> in SURVEY Configuration, Auto Points page.</p> <p>If Annot 4 has been configured to be used in the currently active display mask, the seismic record format has priority. The input field changes to <A4: Seismic>.</p>

Next step

CONT (F1) returns to the screen from where **CONFIGURE Seismic Recording** was accessed.

19.8 Ring Buffer

19.8.1 Overview

Description

A ring buffer

- is a second set of raw data recorded in addition to the logging defined in **CONFIGURE Logging of Raw Obs.**
 - can use a different observation rate.
 - has a defined duration for how long raw data is recorded.
 - consists of several files.
 - can be configured and used from an external software using special commands from **Outside World Interface** or Leica Binary 2 format. Documentation for OWI and LB2 is available on request from the Leica Geosystems representative.
 - can be configured on the RX1210.
 - has a number.
-

Use of ring buffers

Ring buffers are used for monitoring an event.

Example: Data is collected for earthquake monitoring. The standard data is logged every 10 s and is continuously stored. The raw data for the ring buffer is logged at 1 s. After an hours worth of raw data, for example, the ring buffer file is overwritten by a new ring buffer file. If an earthquake occurs the ring buffer file provides the detailed data needed to study the event.

Active ring buffer

A ring buffer is active when logging of raw observations for it has started.

One ring buffer can be active at one time. Before starting another ring buffer the active ring buffer must be stopped.

Reserved space on memory device

When a ring buffer is activated a check is made that there is enough free space on the CompactFlash card or in the internal memory to log the data with the defined observation rate and data interval. This required space is reserved, so that it cannot be used by other applications such as logging the standard set of raw data.

Example: For a ring buffer with a time interval of 1 h, the last 1 h of stored data is always available. Data older than 1 h is automatically overwritten by the data currently being logged.

Ring buffer files

Number of files: Depends on the data interval specified. It is automatically determined.
Example: An interval of 1 h consists of six files each of ten minutes length and a seventh file which is currently logged data to when the ring buffer is active.

Type of files: Measurement database files.

File name: All files for one ring buffer share the same file name.

File extension: The file extensions for the files of one ring buffer differ and increment.

Directory: \DATA\GPS\RINGBUF on the chosen memory device.

Point ID

RBxxxxff is the point ID for a static point which is stored into the ring buffer.

Field	Description
RB	Ring buffer
xxxx	Receiver ID, four characters. Default: Last four digits of the receiver serial number
ff	Ring buffer number, two characters

19.8.2 Configuring and Using a Ring Buffer

Access

Select **Main Menu: Config...\Survey Settings...\Ring Buffer**.



This option is not available for RX1250 with SmartAntenna.



The configuration of an active ring buffer cannot be changed. In order to change the configuration of a ring buffer, raw data logging for the ring buffer must be stopped and the recorded raw data must be deleted.

CONFIGURE Ring Buffer

```

11:54
CONFIGURE
Ring Buffer
Buffer No. : 1
Status : Inactive
Configuration: No. of Files 1
Log Rate : 1.0s
Dynamics : Static
Device : CF Card
File length : 1 min
No. of Files : 2
Q1a
START DEL
    
```

START (F3) or STOP (F3)

To activate and deactivate the ring buffer and to start/stop logging raw data for the ring buffer.

DEL (F4)

To delete the logged raw data.

Description of fields

Field	Option	Description
<Buffer No.:>	From 0 to 9	The number of the ring buffer to be configured or used. Up to ten ring buffers can be configured, one ring buffer can be used at a time.
<Status:>	Active Inactive	Raw data is being logged to the ring buffer. No raw data is being logged to the ring buffer.
<Configura- tion:>	Overall Length No. of Files	How the total length of the ring buffer is defined. The time span of the ring buffer is defined in <Data Interval:>. The splitting into individual files is done automatically by the receiver. The time span of the ring buffer results from the user inputs for <File Length:> and <No. of Files>. This option helps controlling the file length for downloading.
<Log Rate:>	From 0.05s to 300s	Rate at which raw data is logged to the ring buffer.
<Dynamics:>	Static or Moving	Raw data for a ring buffer can be logged in static or moving mode.
<Device:>	CF Card or Internal	The device on which the raw data will be stored. Depending on the receiver options, this may be an output field.

Field	Option	Description
<Data Interval:>	From 10 min to 4 weeks	Available for <Configuration: Overall Length>. The duration for how long data is recorded to the ring buffer before newly observed data is recorded over the oldest data.
<File Length:>	From 1 min to 24 h	Available for <Configuration: No. of Files>. For how long data are written to one file before a new file is created.
<No. of Files:>	User input	Available for <Configuration: No. of Files>. Defines how many files are required for the ring buffer logging. This is also the number of complete files which are kept before overwriting old ones.  Every power failure of the receiver will cause a new file to be started. The number of files to be created as defined in this field stays the same. It is recommended to configure a higher number of files, if the power supply of a receiver is not reliable due to infrastructure constraints. This will increase the time span covered by the ring buffer in case of power failures.

Next step

IF	THEN
a ring buffer is to be activated	select the desired <Buffer No.:>. START (F3) .

IF	THEN
a ring buffer is to be deactivated	select the desired <Buffer No.:>. STOP (F3) .
the raw data on a deactivated ring buffer is to be deleted	select the desired <Buffer No.:>. DEL (F4) .
the screen is to be quit	ESC .

20**Config...\Instrument Settings...**

20.1**Antenna & Antenna Heights**

Description

The settings on this screen define the antenna and the default height for the antenna. Refer to "2 Antenna Heights" for all information about antenna heights.

Access

Select **Main Menu: Config...\Instrument Settings...\Antenna & Antenna Heights**.

OR

Press a hot key configured to access the screen **CONFIGURE Antenna & Antenna Heights**. Refer to "6.1 Hot Keys" for information on hot keys.

OR

Press **USER**. Refer to "6.2 USER Key" for information on the **USER** key.

OR

Within the configuration set wizard. Refer to "14.2 Accessing Configuration Set Management".

CONFIGURE Antenna & Antenna Heights

11:57

CONFIGURE

Antenna & Antenna Heights

Antenna : AX1202 Pole

Default Ht : 2.000 m

Vert Offset : 0.000 m

Meas Type : Vertical

Moving Ht : 2.000 m

CONT Q1a ↑

CONT (F1)

To accept changes and return to the screen from where this screen was accessed.

Description of fields

Field	Option	Description
<Antenna:>	Choicelist	Antennas in the receiver's System RAM or as defined in Main Menu: Manage...Antennas .
<Default Ht:>	User input	Sets the default antenna height for the current configuration. This is then also the default antenna height during the use of application programs. The antenna height can still be changed during a survey. The change will not update <Default Ht:> in the configuration. The initial value depends on the selected antenna.
<Vert Offset:>	Output	The vertical antenna offset for the selected antenna.

Field	Option	Description
<Meas Type:>	Slope or Vertical	The way the antenna height will be measured.
<Horiz Offset:>	Output	Available for <Meas Type: Slope>. The horizontal antenna offset for the selected antenna.
<Moving Ht:>	User input	Sets the default antenna height for auto points and for the moving part of a track when logging raw observations.

Next step

CONT (F1) returns to the screen from where **CONFIGURE Antenna & Antenna Heights** was accessed.

20.2

Satellite Settings

Description

The settings on this screen define which satellite system (available for GX1230 GG/ ATX1230 GG), satellites and satellite signals will be used by the receiver.

Access

Select **Main Menu: Config...\Instrument Settings...\Satellite Settings**.

OR

Within the configuration set wizard. Refer to "14.2 Accessing Configuration Set Management".

CONFIGURE Satellite Settings

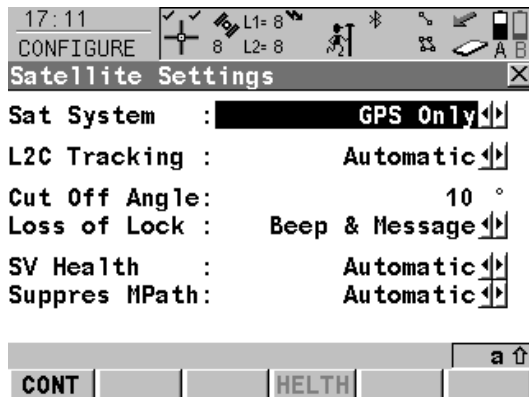

CONT (F1)

To accept changes and return to **GPS1200 Main Menu**.

HELTH (F4)

Available for **<SV Health: User Defined>**. To configure the satellites used in the survey. Refer to paragraph "CONFIGURE Satellite Tracking".

SHIFT INIT(F4)

Force the receiver to delete the current GPS and GLONASS almanac stored on the receiver and to download new almanacs.

Description of fields

Field	Option	Description
<Sat System:>	<p>GPS Only</p> <p>GPS & Glonass</p>	<p>Available for GX1230 GG/ATX1230 GG. Defines the satellite signals accepted by the receiver when tracking satellites.</p> <p>Only GPS satellites are tracked.</p> <p>GPS and GLONASS satellites are tracked.</p>
<L2C Tracking:>	Automatic or Always Track	<p>Available for GX1230 (serial number > 465000)/GX1230 GG/ATX1230 GG. Defines if the L2C signal will be tracked. The recommended setting is Automatic.</p>
<Cut Off Angle:>	User input	<p>Sets the elevation in degrees below which satellite signals are not recorded and are not shown to be tracked. Recommended settings:</p> <ul style="list-style-type: none"> • For real-time: 10°. • For purely post-processing applications: 15°.
<Loss of Lock:>	Beep & Message or No Beep/Message	<p>Activates an acoustic warning signal and a message given by the receiver when satellites are lost and therefore no position can be computed.</p>
<SV Health:>		<p>Sets the satellite tracking behaviour.</p> <p> This setting is remembered when the receiver is turned off. It is stored as part of the configuration set.</p>

Field	Option	Description
	Automatic	Incoming satellite signals are monitored by the receiver. Data from signals which are flagged as unhealthy are neither recorded nor used for real-time computations.
	User Defined	Satellites must manually be included/excluded from data recording and real-time computations with HEALTH (F4) .
<Suppress MPath:>	Automatic or Always On	Available for GX1230 GG/ATX1230 GG. Defines if phase multipath mitigation techniques will be used. The recommended setting is Automatic .

Next step

IF satellites used in the survey	THEN
are not to be configured	CONT (F1) closes the screen and returns to the screen from where CONFIGURE Satellite Settings was accessed.
are to be configured	HEALTH (F4) . Refer to paragraph "CONFIGURE Satellite Tracking".

CONFIGURE Satellite Tracking

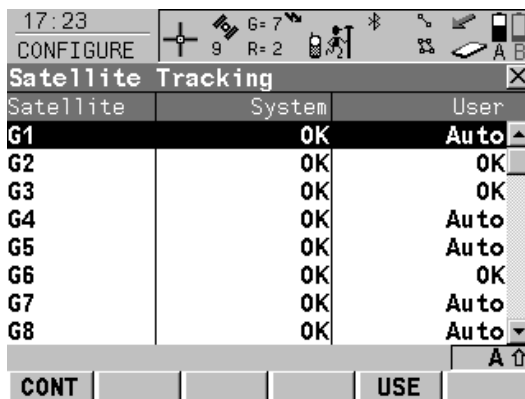

CONT (F1)

To accept changes and return to the screen from where this screen was accessed.

USE (F5)

To change between the options in the column User.

Description of columns

Column	Option	Description
Satellite	01 to 32	The Pseudo Random Noise number (GPS, 1 to 32) or the Slot ID (GLONASS, 1 to 24) of the satellites. There is a prefix G for GPS satellites and a prefix R for GLONASS satellites for GX1230 GG, ATX1230 GG and GRX1200 GG Pro .
System	OK, N/A or Unhealthy	Information on the satellite health taken from the almanac. N/A stands for not available.
User	Bad OK	Excludes satellite from tracking. Includes satellite in tracking.

Column	Option	Description
	Auto	Automatic satellite tracking when satellite is healthy.  This setting is remembered until the receiver is turned off. It is not stored as part of the configuration set. After turning the receiver on, Auto is always set.

Next steps

Step	Description
1.	CONT (F1) returns to CONFIGURE Satellite Settings .
2.	CONT (F1) returns to GPS1200 Main Menu .

20.3

Time Zone

Description

The settings on this screen help the receiver to quickly locate and track satellites.

Access

Select **Main Menu: Config...\Instrument Settings...\Time Zone**.

OR

Within the configuration set wizard. Refer to "14.2 Accessing Configuration Set Management".

CONFIGURE

Local Time Zone

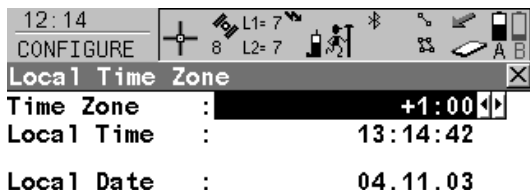

CONT (F1)

To accept changes and to return to **GPS1200 Main Menu**.



Description of fields

Field	Option	Description
<Time Zone:>	From -13:00 to +13:00	The time zone for the current location and local date.

Field	Option	Description
<Local Time:> <Local Date:>	User input	Setting the local time and date supports a very fast satellite acquisition.

Next step

CONT (F1) returns to **GPS1200 Main Menu**.

20.4

Instrument ID

Description

The settings on this screen define the instrument identification number. This number is used for the generation of the file names. Using format files, the instrument ID can be output together with data from the instrument. By doing so, it can be identified which instrument was used for certain measurements.

Access

Select **Main Menu: Config...\Instrument Settings...\Instrument ID**.

CONFIGURE Instrument ID

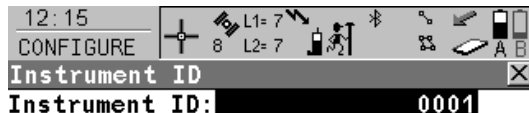

CONT (F1)

To accept changes and to return to **GPS1200 Main Menu**.

DEFLT (F5)

To recall the default instrument ID.



Description of fields

Field	Option	Description
<Instrument ID:>	User input	Sets a four digit number as instrument identification number. By default the last four numbers of the serial number are used.

Next step

CONT (F1) returns to **GPS1200 Main Menu**.

20.5

Set NET Parameters



Description

The **Set NET Parameters** option is available on the GRX1200 Pro and GRX1200 GG Pro.

The settings on the screen allow the network parameters to be defined for the Ethernet device.

Typical uses

The Ethernet connection can be used to remotely

- download data from a reference station.
- access, control and configure a reference station.

The use of the Ethernet connection could be of interest in the following examples:

Example 1: A receiver is set up on a glacier and is connected to the Internet via the Ethernet connection. A computer in a remote location can be used to access the receiver and download data about the position of the receiver as well as perform any controlling or configuring functions that are required.

Example 2: A permanent reference station on a mountain used to measure movement is connected to the Internet via the Ethernet connection and can be accessed, controlled and configured using a computer in the office.

Example 3: A reference station on top of a survey company's building is used to broadcast real-time corrections and is connected to the company's intranet via the Ethernet connection. The reference station can be accessed, controlled and configured by the survey personnel within the company.

Access

Select **Main Menu: Config...\Instrument Settings...\Set NET Parameters.**

OR

Within the configuration set wizard. Refer to "14.2 Accessing Configuration Set Management".

CONFIGURE Set NET Parameters

15:03
CONFIGURE
Set NET Parameters
IP Address : 10.61.12.102
Network Mask : 255.255.253.0
Gateway
IP Address : 10.61.12.1

CONT (F1)

To return to **GPS1200 Main Menu**.

CLEAR (F5)

To reset all fields to their default values.

CONT CLEAR Q1 a ↑

Description of fields

Field	Option	Description
<IP Address:>	User input	The Internet Protocol address of the receiver. It is a 32 bit number which must be obtained from the network administrator or the Internet service provider. The format of the IP address is aaa.bbb.ccc.ddd where aaa is a value ranging from 001 to 254 and bbb, ccc and ddd are values ranging from 000 to 254.

Field	Option	Description
<Network Mask:>	User input	<p>Used together with the IP address to identify the network the receiver is on. It is a 32 bit number which must be obtained from the network administrator or the Internet service provider.</p> <p>The format of the network mask is aaa.bbb.ccc.ddd where aaa is a value ranging from 001 to 255 and bbb, ccc and ddd are values ranging from 000 to 255.</p>
<Gateway IP Address:>	User input	<p>The IP address of a local default IP router on the same network. It is used to forward traffic to destinations beyond the local network.</p> <p>A gateway is the connection or interchange point that connects separate IP networks. For example a Local Area Network may need a gateway to connect it to the Internet.</p>

Next step

CONT (F1) returns to **GPS1200 Main Menu**.

21 Config...\General Settings...

21.1 Wizard Mode

Description

The settings on this screen define the behaviour of the configuration set wizard.

Access

Select **Main Menu: Config...\General Settings...Wizard Mode**.

OR

Within the configuration set wizard. Refer to "14.2 Accessing Configuration Set Management".

CONFIGURE Wizard Mode



CONT (F1)

To accept changes and to return to **GPS1200 Main Menu** or to continue with the subsequent screen within the configuration set wizard.

LIST (F6)

To access **CONFIGURE Quick Access**. Lists all screens within a configuration set. Allows to access these individual screens and change settings.



Description of fields

Field	Option	Description
<Wizard Mode:>	View All Screens	All configuration screens are shown in the configuration set wizard. Application program configuration screens are not included. They can be configured within each application program.
	Reduced	A reduced set of screens are shown in the configuration set wizard.

Next step

CONT (F1) returns to **GPS1200 Main Menu** or continues with the subsequent screen within the configuration set wizard.

21.2

Hot Keys & User Menu

Description

The settings on this screen assign a particular function, screen or application program to each of the first and second level of hot keys and to the **USER** key. Refer to "6 Configurable Keys" for more information on hot keys and the **USER** key.

Access

Select **Main Menu: Config...\General Settings...\Hot Keys & User Menu.**

OR

Press a hot key configured to access the screen **CONFIGURE Hot Keys & User Menu.** Refer to "6.1 Hot Keys" for information on hot keys.

OR

Press **USER.** Refer to "6.2 USER Key" for information on the **USER** key.

OR

Within the configuration set wizard. Refer to "14.2 Accessing Configuration Set Management".

OR

Hold a hot key down for two seconds. This is also possible after pressing **SHIFT.**

**CONFIGURE
Hot Keys & User Menu,
Hot Keys page**

To configure the first level of hot keys.



```

F7 : FUNC Select Free Code
F8 :          MGMT Data
F9 :          STAT Satellite Status

F10:          STAT Current Position
F11:          STAT Battery & Memory
F12:          FUNC Touch Screen On/Off
    
```



CONT (F1)

To accept changes and return to the screen from where this screen was accessed.

PAGE (F6)

To change to another page on this screen.

Description of fields

Field	Option	Description
<F7:> to <F12:>	Choicelist	All functions, screens or application programs which can be assigned to the particular key.

Next step

PAGE (F6) changes to the **Shift Hot Keys** page. Refer to paragraph "CONFIGURE Hot Keys & User Menu, Shift Hot Keys page".

CONFIGURE
Hot Keys & User Menu,
Shift Hot Keys page

To configure the second level of hot keys.
 The functionality on this page is identical to the one on the **Hot Keys** page.

Next step

PAGE (F6) changes to the **User Menu** page. Refer to paragraph "CONFIGURE Hot Keys & User Menu, User Menu page".

CONFIGURE
Hot Keys & User Menu,
User Menu page

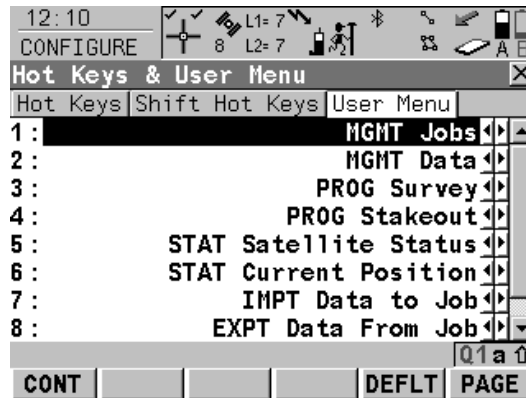

CONT (F1)

To accept changes and return to the screen from where this screen was accessed.

PAGE (F6)

To change to another page on this screen.

Description of fields

Field	Option	Description
<1:> to <9:>	Choicelist	All functions, screens or application programs which can be assigned to the individual lines in the user defined menu.

Next step

PAGE (F6) changes to the first page on this screen.

21.3

Units & Formats

Description

The settings on this screen define

- the units for all types of measurement data displayed.
 - information related to some types of measurement data.
 - the order in which coordinates are displayed.
-

Access

Select **Main Menu: Config...\General Settings...\Units & Formats.**

OR

Press a hot key configured to access the screen **CONFIGURE Units & Formats**. Refer to "6.1 Hot Keys" for information on hot keys.

OR

Press **USER**. Refer to "6.2 USER Key" for information on the **USER** key.

OR

Within the configuration set wizard. Refer to "14.2 Accessing Configuration Set Management".

CONFIGURE
Units & Formats,
Units page

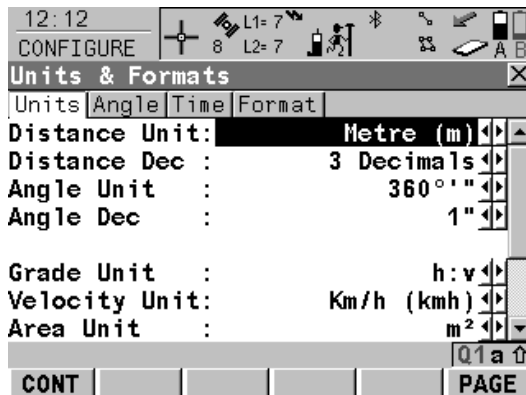

CONT (F1)

To accept changes and return to the screen from where this screen was accessed.

PAGE (F6)

To change to another page on this screen.

Description of fields

Field	Option	Description
<Distance Unit:>	Metre (m)	Metres [m]
	Int Ft (fi)	International feet [fi], storage in US feet
	Int Ft/Inch (fi)	International feet [fi], inches and 1/8 inches (0' 00 0/8 fi), storage in US feet
	US Ft (ft)	US feet [ft]
	US Ft/Inch (ft)	US feet, inches and 1/8 inches (0' 00 0/8 fi) [ft]
	US Miles (mi)	US miles [mi]

Field	Option	Description
	Kilometres (km)	Kilometres [km]
<Distance Dec:>	From 0 Decimals to 4 Decimals	The number of decimal places shown for all distance and coordinate related fields. This is for data display and does not apply to data export or storage. The available options depend on the selected <Distance Unit:> .
<Angle Unit:>	400 gon, 360 ° ' " , 360° dec or 6400 mil	The units shown for all angular and coordinate related fields. More angle settings can be defined on the Angle page.
<Angle Dec:>	From 1 Decimal to 3 Decimals From 2 Decimals to 4 Decimals 1'' , 5'' , 10'' , 60''	The number of decimal places shown for all angular and coordinate related fields. This is for data display and does not apply to data export or storage. Available for <Angle Unit: 6400 mil> . Available for <Angle Unit: 400 gon> and <Angle Unit: 360° dec> . Available for <Angle Unit: 360 ° ' '> .
<Grade Unit:>	h:v v:h % (v/h * 100) Elev Angle	The input and output format for grades. Horizontal by vertical distance. Vertical by horizontal distance. Percentage of vertical by horizontal distance. Elevation angle.

Field	Option	Description
<Velocity Unit:>	Km/h (kmh), Mph (mph) or Knots (kn)	The units shown for all velocity related fields.
<Area Unit:>	m ² , Int Acres (Ai), US Acres (A), Hectares (ha), fi ² or ft ²	The units shown for all area related fields.
<Temp Unit:>	Celsius (°C) or Fahrenheit (°F)	The units shown for all temperature related fields.
<Press Unit:>	mbar, mmHg, Inch Hg (inHg), hPa or psi	The units shown for all pressure related fields. PSI = pounds per square inch.

Next step

PAGE (F6) changes to the **Angle** page. Refer to paragraph "CONFIGURE Units & Formats, Angle page".

CONFIGURE
Units & Formats,
Angle page

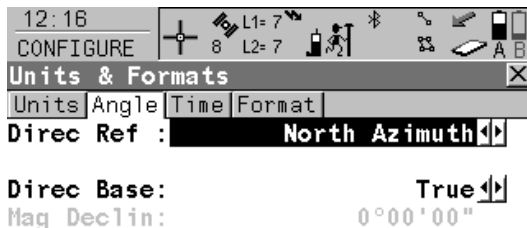

CONT (F1)

To accept changes and return to the screen from where this screen was accessed.



PAGE (F6)

To change to another page on this screen.

Description of fields

Field	Option	Description
<Direc Ref:>	North Azimuth, South Azimuth, North Anticlock or Bearing	Sets the reference direction as well as the direction from where and how azimuths are computed. For <Direc Ref: Bearing>, the azimuth/bearing fields in other screens are called <Bearing:>. NE, SW, SE and NW indicate the quadrant of the bearing.

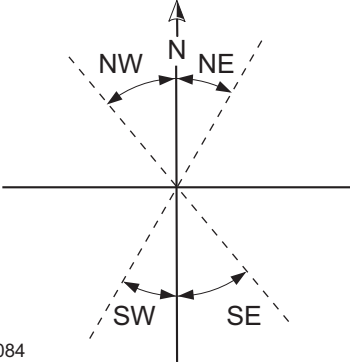
Field	Option	Description
		 <p>GPS12_084</p> <p>For all other options, the azimuth/bearing fields in other screens are called <Azimuth:>.</p>
<Direc Base:>	True or Magnetic	Sets the North direction.
<Mag Declin:>	User input	Available for <Direc Base: Magnetic> . The value for the magnetic declination. It is considered when computing or using any azimuth values.

Next step

PAGE (F6) changes to the **Time** page. Refer to paragraph "CONFIGURE Units & Formats, Time page".

CONFIGURE
Units & Formats,
Time page

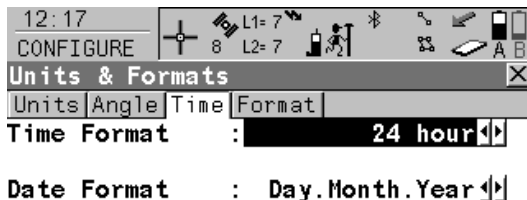

CONT (F1)

To accept changes and return to the screen from where this screen was accessed.



PAGE (F6)

To change to another page on this screen.

Description of fields

Field	Option	Description
<Time Format:>	24 hour or 12 hour (am/pm)	How the time is shown in all time related fields.
<Date Format:>	Day.Month.Year, Month/Day/Year or Year/Month/Day	How the date is shown in all date related fields.

Next step

PAGE (F6) changes to the **Format** page. Refer to paragraph "CONFIGURE Units & Formats, Format page".

CONFIGURE
Units & Formats,
Format page

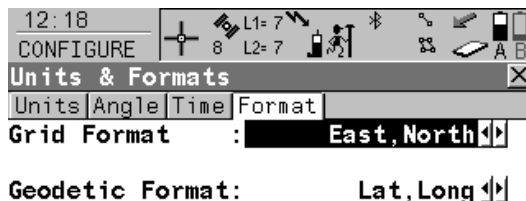

CONT (F1)

To accept changes and return to the screen from where this screen was accessed.



PAGE (F6)

To change to another page on this screen.

Description of fields

Field	Option	Description
<Grid Format:>	East,North or North,East	The order in which grid coordinates are shown in all screens. The order in display masks depends on the user settings.
<Geodetic Format:>	Lat,Long or Long,Lat	The order in which geodetic coordinates are shown in all screens. The order in display masks depends on the user settings.

Next step

PAGE (F6) changes to the first page on this screen.

21.4

Language

Description

The setting on this screen defines the language used on the instrument. Three languages can be stored on the receiver at one time - English and two others. English cannot be deleted. Refer to "27.2 System Languages" for information on uploading languages.

Access

Select **Main Menu: Config...\General Settings...\Language**.

CONFIGURE

Languages on Instrument



CONT (F1)

To accept changes and return to **GPS1200 Main Menu**.

DEL (F1)

To delete the highlighted language.



Description of columns

Field	Description
Language	The languages available on the receiver.

Field	Description
	The selected language is used for the system software. If a language is not available for the system software, the English language is used instead. Application programs run in the language they were loaded.

Next step

CONT (F1) returns to **GPS1200 Main Menu**.

21.5

Display, Beeps, Text

Description

The settings on this screen allow the screen appearance to be configured, turn the notification beeps on and off and define the behaviour of the keys. The settings are stored on the RX1200 itself. If RX1200's are exchanged, the settings stored on the new RX1200 apply.

Access

Select **Main Menu: Config...\General Settings...\Display, Beeps, Text.**

CONFIGURE

Display, Beeps, Text,
Display page

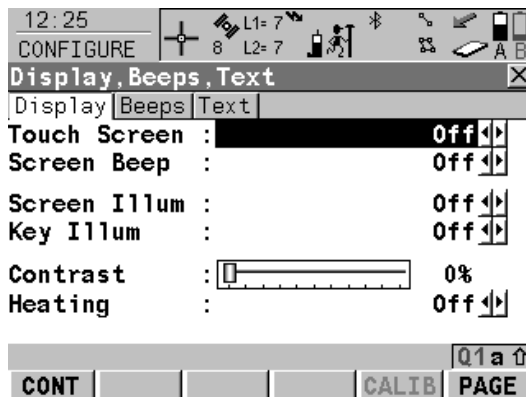

CONT (F1)

To accept changes and return to **GPS1200 Main Menu.**

CALIB (F5)

To calibrate the touch screen.

PAGE (F6)

To change to another page on this screen.

Description of fields

Field	Option	Description
<Touch Screen:>	On or Off	Turns touch screen on and off.

Field	Option	Description
<Screen Beep:>	Off, Soft or Loud	Controls the beep upon touching the touch screen.
<Screen Illum:>	Off, Always On, On for 1 min, On for 2 min or On for 5 min	Controls the screen illumination to be on, off or on for the specified time after the last key was pressed, or touch screen event.
<Key Illum:>	Off, Same as Screen or Always On	Controls the keyboard illumination.
<Contrast:>	From 0% to 100%	Adjust the contrast level for the display with the right and left arrow key when the field is highlighted or using the supplied stylus on the slider.
<Heating:>	Automatic Off	The screen heating comes on automatically at 5°C and shuts off again at 7°C. The screen heating never comes on.

Next step

PAGE (F6) changes to the **Beeps** page. Refer to paragraph "CONFIGURE Display, Beeps, Text, Beeps page".

CONFIGURE
Display, Beeps, Text,
Beeps page

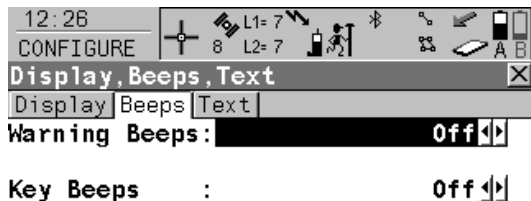

CONT (F1)

To accept changes and return to the screen from where this screen was accessed.



PAGE (F6)

To change to another page on this screen.

Description of fields

Field	Option	Description
<Warning Beeps:>	Off, Soft or Loud	Controls the beep for acoustic warning signals.
<Key Beeps:>	Off, Soft or Loud	Controls the beep upon key presses on the RX1200.

Next step

PAGE (F6) changes to the **Text** page. Refer to paragraph "CONFIGURE Display, Beeps, Text, Text page".

CONFIGURE
Display, Beeps, Text,
Text page

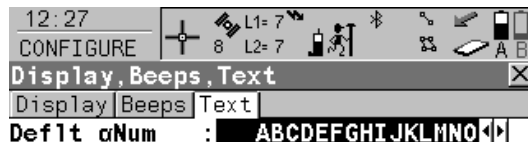

CONT (F1)

To accept changes and return to the screen from where this screen was accessed.



PAGE (F6)

To change to another page on this screen.

Description of fields

Field	Option	Description
<Deflt αNum:>	Choiclist	Sets the set of extra characters available through αNUM or F1-F6 whenever an entry is made. The choices available depend on the character sets loaded on the instrument and the language configured to be used on the instrument.

Next step

PAGE (F6) changes to the first page on this screen.

21.6

Start Up & Power Down



Description

Power Down is unavailable for a RX1250 with SmartAntenna.

The settings on this screen

- define the behaviour of the instrument for a general start up.
- define the behaviour of the instrument when starting up after a power loss.
- define a PIN code which needs to be typed in on starting up the receiver.

Start Up

The screen entered after turning on the instrument can be configured.

Power Down

Once power is restored after a power loss the instrument returns to the screen in which it was operating when the power failed. After restarting, the instrument uses the same job and configuration set as before the power loss. If either the job or configuration set are not available the first in the list is used.

Two types of power loss could be experienced:

- Sudden power loss: Internal or external battery being removed.
- Gradual power loss: Internal or external battery running down naturally.

PIN Code

A Personal Identification Number protection can be activated.

Type	Description
PIN protection active	Receiver prompts for PIN code entry <ul style="list-style-type: none"> • after starting up. • when changing the PIN code in CONFIGURE Start Up & Power Down. The PIN code is not checked if a wake-up session starts.
PIN code generation	By the user.
Attempts for correct PIN code	Five. After five false attempts, a Personal Unblock ing code must be typed in.
PUK code generation	<ul style="list-style-type: none"> • By Leica Geosystems. • For receivers delivered with firmware version 2.10 or higher, the PUK code comes with the receiver. • For receivers delivered with firmware versions lower than v2.10, contact a Leica representative to obtain a PUK code.

Access

Select **Main Menu: Config...\General Settings...\Start Up & Power Down.**

OR

Within the configuration set wizard. Refer to "14.2 Accessing Configuration Set Management".

CONFIGURE

**Start Up & Power Down,
Start Up page**

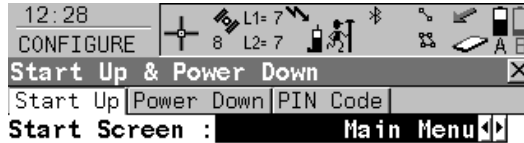

Start on Pulse to Port

Port 1 : No
 Port 2 : No
 Port 3 : No

CONT (F1)

To accept changes and to return to **GPS1200 Main Menu**.



PAGE (F6)

To change to another page on this screen.

Description of fields

Field	Option	Description
<Start Screen:>	Choicelist	Determines the screen entered after turning on the receiver.
<Port 1:> <Port 2:> <Port 3:>	Yes or No	Determines if the receiver powers up when a pulse is received at one of the ports. The fields are unavailable for RX1250 with SmartAntenna.

Next step

PAGE (F6) changes to the **Power Down** page. Refer to paragraph "CONFIGURE Start Up & Power Down, Power Down page".

CONFIGURE
Start Up & Power Down,
Power Down page

This page is not available for RX1250 with SmartAntenna.

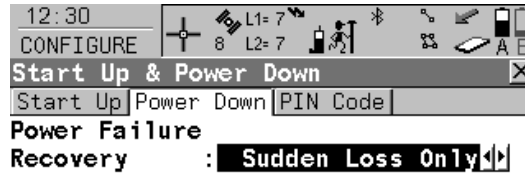

CONT (F1)

To accept changes and to return to **GPS1200 Main Menu**.



PAGE (F6)

To change to another page on this screen.

Description of fields

Field	Option	Description
<Recovery:>	<p>Sudden Loss Only</p> <p>Always</p>	<p>Sets the behaviour of the receiver after power failure when power is restored.</p> <p>The receiver turns itself back on automatically once power is restored after a sudden power loss.</p> <p>The receiver turns itself back on automatically once power is restored after a sudden power loss or after gradual power loss. The receiver returns to the screen in which it was operating when the power failed.</p>

Field	Option	Description
<Set Primary:>	External A, External B or Automatic	Available for the GRX1200 Series where batteries can be attached to port PWR with a Y-cable. Sets the external battery which is always used when sufficient power is available, regardless of the status of the other battery. Primary power sources must provide a minimum voltage of 11.4 V.

Next step

PAGE (F6) changes to the **PIN Code** page. Refer to paragraph "CONFIGURE Start Up & Power Down, PIN Code page".

**CONFIGURE
Start Up & Power Down,
PIN Code page**

The appearance of the screen varies with the setting for **<Use PIN:>** when this screen is accessed.

The softkeys are identical with those on the **Power Down** page. Refer to paragraph "CONFIGURE Start Up & Power Down, Power Down page" for an explanation of softkeys.

<Use PIN: No>

No PIN code has been set before.

- The PIN code protection can be activated.
- Then a PIN code can be typed in.

<Use PIN: Yes>

A PIN code has been set before.

- The PIN code must be typed in order to change settings on this page.
- Then the PIN code protection can be deactivated.
- Or the PIN code can be changed.

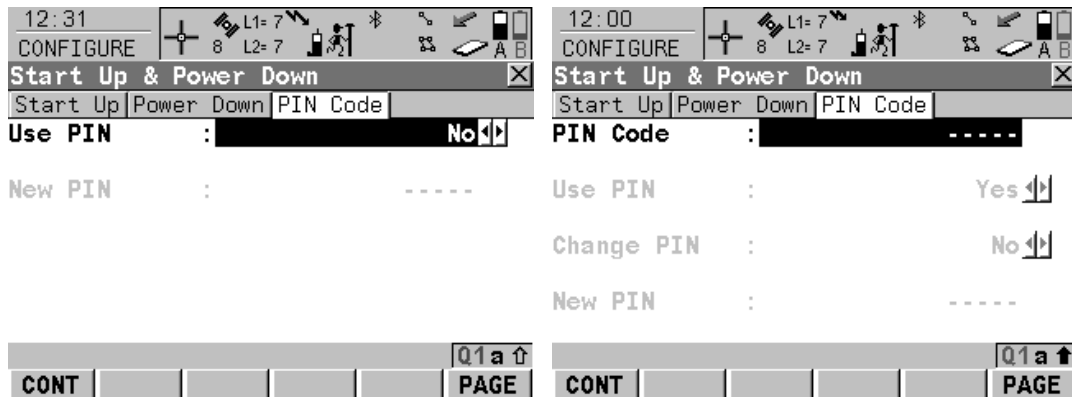

Description of fields

Field	Option	Description
Use PIN	Yes or No	Activates the PIN code protection. This setting is not part of the configuration set.
New PIN	User input	The PIN code must be a number with four to six digits.
PIN Code	User input	The PIN code as previously defined on this page. The correct PIN code must be typed in within five attempts or the PUK code is required. Refer to "5 Receiver Protection with PIN".
Change PIN	Yes or No	Activates <New PIN:> to type in a new PIN code.

Next step

PAGE (F6) changes to the first page on this screen.

22

Config...\Interfaces... - General

22.1

Overview

Description

The receiver has a variety of interfaces which can be configured to be used with different ports and devices. The configuration varies depending on the individual application.

Interface, port and device

Description of the technical terms

Technical term	Description	Example
Interface	An interface should be considered as a function of the receiver.	Real-Time
Port	The physical port on the instrument which will be used for the interface functionality. It is sometimes necessary to use particular ports with certain interfaces.	Port P1
Device	The hardware which is connected to the chosen port.	Radio

22.2

Accessing Configuration Interfaces

Access

Select **Main Menu: Config...Interfaces...**

OR

Press a hot key configured to access the screen **CONFIGURE Interfaces**. Refer to "6.1 Hot Keys" for information on hot keys.

OR

Press **USER**. Refer to "6.2 USER Key" for information on the **USER** key.

CONFIGURE Interfaces

The screen gives an overview of all interfaces with the currently assigned port and device. If a second real-time interface is configured it will also be shown.

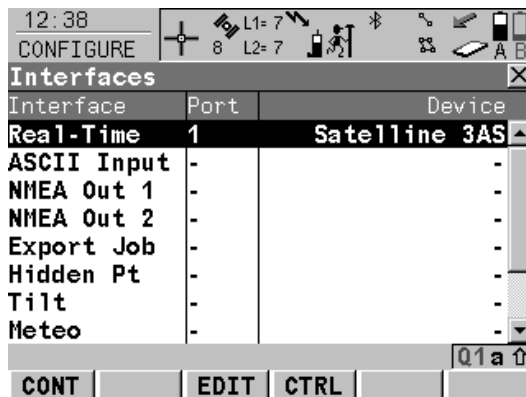

The screenshot shows a handheld device screen with a status bar at the top displaying the time 12:38 and various icons. Below the status bar is a title bar for the 'CONFIGURE Interfaces' screen. The main content is a table with three columns: 'Interface', 'Port', and 'Device'. The 'Real-Time' interface is highlighted in black with white text, showing '1' in the Port column and 'Satellite 3AS' in the Device column. Other interfaces listed include ASCII Input, NMEA Out 1, NMEA Out 2, Export Job, Hidden Pt, Tilt, and Meteo. At the bottom of the screen, there are four buttons labeled 'CONT', 'EDIT', 'CTRL', and 'Q1 a ↑'.

Interface	Port	Device
Real-Time	1	Satellite 3AS
ASCII Input	-	-
NMEA Out 1	-	-
NMEA Out 2	-	-
Export Job	-	-
Hidden Pt	-	-
Tilt	-	-
Meteo	-	-

CONT (F1)

To return to the screen from where this screen was accessed.

EDIT (F3)

To configure the parameters related to the highlighted interface. Refer to the sections on each individual interface below.

CTRL (F4)

Available for certain devices connected to certain interfaces. To configure additional parameters, for example changing channels of radios.

SHIFT CONEC (F4) and SHIFT DISCO (F4)

Available for a real-time interface configured to use a device of type digital cellular phone or modem. To dial the number of another station configured in the active configuration set and to hang up again.

Description of columns

Column	Option	Description
Port	1, 2 or 3	The physical port P1, P2 or P3 on the instrument which will be used for the interface functionality.
	BT x	The Bluetooth port which will be used for the interface functionality. Available for RX1250.
	Clip	Clip-on-contacts on RX1250. It is used for RX1250 with GHT56 when a device is attached to the GHT56.
	NETx	The logical NET port which will be used for the interface functionality. Available for an activated Internet interface.
Device	<Port x>	Default device for the physical ports P1, P2 and P3.
	<Clip-on>	Default device for the physical LEMO port on the GHT56. It is displayed for RX1250 with GHT56 when <Port: Clip-on> is selected.

Next step

IF	THEN
an interface is to be edited	highlight the interface to be configured and EDIT (F3) . Refer to the sections in this chapter on each individual interface.
a device attached to an interface is to be configured	highlight the relevant interface and CTRL (F4) . Refer to "24 Config...\Interfaces... - Controlling Devices" for information on the functionality.

22.3

Real-Time

22.3.1

Overview

Description

The real-time interface allows real-time related parameters to be configured. This includes defining if the receiver should work as a reference or a rover and the real-time messages to be used. Up to two real-time interfaces can be configured on the receiver.

Access

Select **Main Menu: Config...\Interfaces....** Highlight **Real-Time. EDIT (F3)**.

OR

Press a hot key configured to access the screen **CONFIGURE Real-Time Mode**. Refer to "6.1 Hot Keys" for information on hot keys.

OR

Press **USER**. Refer to "6.2 USER Key" for information on the **USER** key.

OR

Within the configuration set wizard. Refer to "14.2 Accessing Configuration Set Management".

Depending on the access, some options are not editable.

Next step

IF the real-time interface is	THEN
not to be used	Refer to "22.3.2 Configuration without Real-Time Interface".
for a reference	Refer to "22.3.3 Configuration of a Reference Real-Time Interface".
for a rover	Refer to "22.3.4 Configuration of a Rover Real-Time Interface".

IF the real-time interface is	THEN
for use with both digital cellular phone and radio	Refer to "22.3.5 Configuration with Digital Cellular Phone and Radio".

22.3.2

Configuration without Real-Time Interface

Access

Refer to "22.3.1 Overview" to access **CONFIGURE Real-Time Mode**.

CONFIGURE Real-Time Mode

<R-Time Mode: None> means the receiver is not to be used as a real-time reference or as a real-time rover.

Next step

IF a Space-Based Augmentation System	THEN
needs to be configured	SHIFT SBAS (F5) to access CONFIGURE SBAS Tracking Mode .
does not need to be configured	CONT (F1) returns to the screen from where CONFIGURE Real-Time Mode was accessed.

22.3.3

Configuration of a Reference Real-Time Interface

Access

Refer to "22.3.1 Overview" to access **CONFIGURE Real-Time Mode**.

CONFIGURE Real-Time Mode

The available fields and keys on this screen depend on the selected settings.

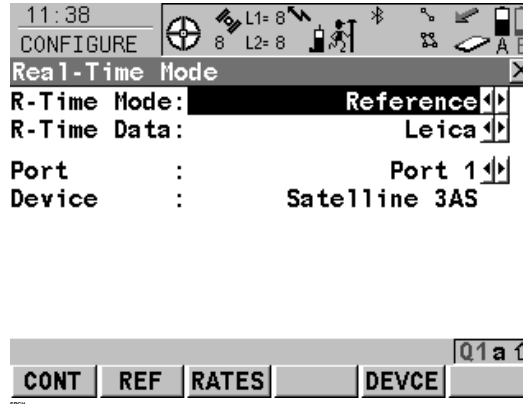

CONT (F1)

To accept changes and return to the screen from where this screen was accessed.

REF (F2)

To configure additional settings relevant to reference, e.g. time slicing. Refer to paragraph "CONFIGURE Additional Reference Options, General page".

RATES (F3)

To configure the data rates for the selected real-time data format. Refer to paragraph "CONFIGURE Real-Time Data Rates".

SRCH (F4)

Available on RX1250 with **<Port: Bluetooth x>** and a Bluetooth device being selected. To search for all available Bluetooth devices. If more than one Bluetooth device is found a list of available devices is provided.

DEVE (F5)

Available unless **<Port: NETx>**. To create, select, edit or delete a device. Refer to "23.2 Accessing CONFIGURE Devices / CONFIGURE GPRS Internet Devices".

SHIFT RT-2 (F2)

To accept the settings and configure a second reference real-time interface. Refer to paragraph "CONFIGURE Real-Time Mode (2)".

SHIFT SBAS (F5)

To configure the **Space-Based Augmentation System** to be used. Refer to "22.3.6 Configuration of SBAS".



Two real-time devices can be attached to two different ports, for example a radio and a digital cellular phone. On the reference, the two devices can operate simultaneously. Press **SHIFT RT-2 (F2)** to configure a second real-time interface.

Description of fields

Field	Option	Description
<R-Time Mode:>	None, Reference or Rover	<R-Time Data: Reference> activates a reference real-time interface.
<R-Time Data:>	Leica CMR CMR+	The proprietary Leica real-time GPS data format. This is recommended when working exclusively with Leica receivers. CMR and CMR+ are compacted formats used to broadcast data for third party receivers.

Field	Option	Description
	RTCM v3	<p>Use RTCM when rover units from a different manufacturer are to be used.</p> <p>Message according to RTCM version 3. A new standard format for transmission of Global Navigation Satellite System correction information. Higher efficiency than RTCM v2.x. Supports real-time services with significantly reduced bandwidth.</p> <p>Message types for real-time GNSS operation:</p> <ul style="list-style-type: none"> • 1001: L1-only GPS real-time observables • 1002: Extended L1-only GPS real-time observables • 1003: L1 & L2 GPS real-time observables • 1004: Extended L1 & L2 GPS real-time observables • 1005: Stationary real-time reference station Antenna Reference Point • 1006: Stationary real-time reference station ARP with antenna height • 1007: Antenna descriptor • 1008: Antenna descriptor and serial number • 1009: L1-only GLONASS real-time observables • 1010: Extended L1-only GLONASS real-time observables

Field	Option	Description
		<ul style="list-style-type: none">• 1011: L1 & L2 GLONASS real-time observables• 1012: Extended L1 & L2 GLONASS real-time observables <p>Network RTK Messages according to Master-Auxiliary Concept:</p> <ul style="list-style-type: none">• 1014: Network Auxiliary Station Data message. This message contains details of the reference stations in the network, for example the master station and its coordinates, and the coordinate differences between the master and its auxiliaries.• 1015: Ionospheric Correction Differences message• 1016: Geometric Correction Differences message <p>Pseudorange and phase range values for L1 and L2. Depending on the type of receiver, the data for L1-only or for L1 and L2 are sent out.</p> <p>Accuracy at the rover:</p> <ul style="list-style-type: none">• For L1-only: 0.25 - 1 m rms.• For L1 and L2: 1 - 5 cm rms after a successful ambiguity resolution.

Field	Option	Description
	RTCM 1,2 v2	Message according to RTCM version 2.x. Differential and delta differential GPS corrections. Message 3 is also generated. Use for DGPS applications. Accuracy at the rover: 0.25 - 1 m rms.
	RTCM 9,2 v2	Message according to RTCM version 2.x. GPS partial correction set and delta differential GPS corrections. Message 3 is also generated. Use for DGPS applications with a slow data link in the presence of interference. Accuracy at the rover: 0.25 - 1 m rms.
	RTCM 18,19 v2	Message according to RTCM version 2.x. Uncorrected carrier phase and pseudorange. Message 3 is also generated. Use for real-time operations where the ambiguities will be resolved at the rover. Accuracy at the rover: 1 - 5 cm rms after a successful ambiguity resolution.
	RTCM 20,21 v2	Message according to RTCM version 2.x. Real-time carrier phase corrections and high-accuracy pseudorange corrections. Message 3 is also generated. Use for real-time operations. Accuracy at the rover: 1 - 5 cm rms after a successful ambiguity resolution.
	RTCM 1,2,18,19 v2	Message according to RTCM version 2.x. Combination of RTCM 1,2 v2 and RTCM 18,19 v2 .
	RTCM 1,2,20,21 v2	Message according to RTCM version 2.x. Combination of RTCM 1,2 v2 and RTCM 20,21 v2 .

Field	Option	Description
<Port:>	Bluetooth x	Available for RX1250. The Bluetooth port which will be used for the interface functionality.
	Clip-on	Available for RX1250. The clip-on-contacts. It is used for RX1250 with GHT56 when a device is attached to the GHT56.
	NETx	Available for an activated Internet interface. If these ports are not assigned to a specific interface, then these ports are additional remote ports.
	Port x	The physical port P1, P2 or P3 on the instrument to which the device is attached.
	Port 1	Available for RX1250. LEMO port on RX1250.

Next step

REF (F2) changes to **CONFIGURE Additional Reference Options, General** page. Refer to paragraph "CONFIGURE Additional Reference Options, General page".

CONFIGURE
Additional Reference
Options,
General page

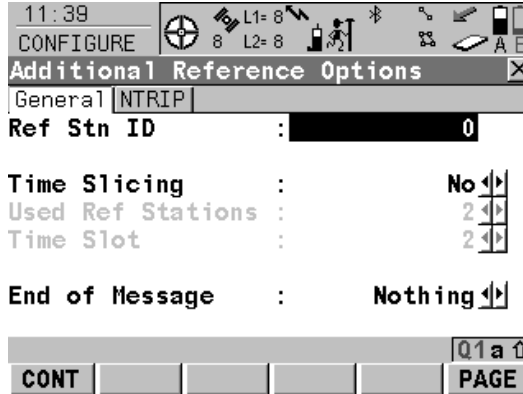

CONT (F1)

To accept changes and return to the screen from where this screen was accessed.

PAGE (F6)

To change to another page on this screen.

Description of fields

Field	Option	Description
<Ref Stn ID:>	User input	<p>An identification for a reference station. It is converted into a compact format and sent out with real-time data in all real-time data formats. It is different from the point ID of the reference station.</p> <p>An ID of the reference station is required if working with several reference stations in time slicing mode on the same frequency. In this case, the ID of the reference station from which data is to be accepted must typed in at the rover.</p> <p>The allowed minimum and maximum values vary.</p>

Field	Option	Description
	From 0 to 31 From 0 to 1023 From 0 to 4095	For <R-Time Data: Leica> and <R-Time Data: CMR/CMR+> in CONFIGURE Real-Time Mode. For <RTCM Version: 1.x> and <RTCM Version: 2.x>. For <R-Time Data: RTCM v3> in CONFIGURE Real-Time Mode.
<Time Slicing:>	Yes or No	The possibility to send real-time messages delayed. This is required when real-time messages from different reference stations are sent on the same radio channel. Time slicing works for all device types.
<Used Ref Stations:>	2, 3 or 4	Available for <Time Slicing: Yes>. The number of reference stations in use from where real-time messages are sent.
<Time Slot:>	2, 3 or 4 The contents of the choicelist depend on the settings for <Used Ref Stations:>.	Available for <Time Slicing: Yes>. The time slot represents the actual time delay. The number of possible time slots is the number of reference stations in use. The time delay equals 1 s divided by the total number of reference stations. If two reference stations are used, the time delay is 0.50 s. Therefore, the time slots are at 0.00 s and at 0.50 s. With three reference stations, the time delay is 0.33 s. The time slots are at 0.00, 0.33 and 0.66 s.
<End of Message:>	Nothing or CR	To add a Carriage Return at the end of the real-time message.

Field	Option	Description
<RTCM Version:>	2.1, 2.2 or 2.3	Available for <R-Time Data: RTCM XX v2> in CONFIGURE Real-Time Mode . The same version must be used at the reference and the rover.

Next step

PAGE (F6) changes to the **NTRIP** page.

CONFIGURE
Additional Reference
Options,
NTRIP page



Password : - - - - -

Mountpnt : WTZJ0

CONT (F1)

To accept changes and return to the screen from where this screen was accessed.



PAGE (F6)

To change to another page on this screen.

Description of fields

Field	Option	Description
<Use NTRIP:>	Yes or No	Activates NTRIP.

Field	Option	Description
<Password:>	User input	A password for authentication is required to send data to the NTRIP Caster. Contact the NTRIP administrator for information.
<Mountpnt:>	User input	Identifies from where data is streamed to the NTRIP Caster.

Next step

Step	Description
1.	CONT (F1) closes the screen and returns to CONFIGURE Real-Time Mode .
2.	RATES (F3) . Refer to paragraph "CONFIGURE Real-Time Data Rates".

CONFIGURE Real-Time Data Rates

Description

For all real-time data formats, parts of the message can be output at different rates. The settings on this screen define the output rates for the various parts of the selected real-time data format. The available fields on this screen depend on the selected setting for **<R-Time Data:>** in **CONFIGURE Real-Time Mode**.

Description of fields

Field	Option	Description
<Data:>	From 0.1s to 60.0s	Rates for the transmission of raw observations. The default settings are suitable for standard applications. They can be changed for special applications. A check is performed for permissible combinations.

Field	Option	Description
<Coords:>	From 10s to 120s	Rate for the transmission of reference coordinates.
<Messages:>	Choicelist	Available for <RTCM Version: 2.3> in CONFIGURE Additional Reference Options, General page. The messages sent within the coordinate message.
<Info:>	From 10s to 120s	Rate for the transmission of reference station information such as point ID.
<Msge Type:>	Choicelist	The message type of <R-Time Data: RTCM v3>. <Msge Type: Compact > is suitable for standard applications.

Next step

Step	Description
1.	CONT (F1) closes the screen and returns to CONFIGURE Real-Time Mode .
2.	SHIFT RT-2 (F2) changes to CONFIGURE Real-Time Mode (2) . Refer to paragraph "CONFIGURE Real-Time Mode (2)".

CONFIGURE Real-Time Mode (2)

Description

The second real-time interface is completely independent from the first one. All settings can be configured differently. The port that is used must be different to the first real-time interface. Refer to paragraph "CONFIGURE Real-Time Mode" above for information on the fields and keys. The difference is, that **SHIFT RT-2 (F2)** is replaced by **SHIFT RT-1 (F2)** and returns to **CONFIGURE Real-Time Mode**.

Next step

IF changes for the first real-time interface	THEN
are not to be made	CONT (F1) accepts the changes, closes the screen and returns to the screen from where CONFIGURE Real-Time Mode was accessed. The second real-time interfaces is added to the list in CONFIGURE Interfaces .
are to be made	SHIFT RT-1 (F2) accepts the settings and returns to CONFIGURE Real-Time Mode .

22.3.4

Configuration of a Rover Real-Time Interface

Access

Refer to "22.3.1 Overview" to access **CONFIGURE Real-Time Mode**.

CONFIGURE Real-Time Mode

The available fields and keys on this screen depend on the selected settings.

11:42
CONFIGURE
Real-Time Mode
R-Time Mode: Rover
R-Time Data: Leica
Port: Port 1
Device: Satellite 3AS
Ref Sensor: GX1230
Ref Antenna: AX1202 Tripod
CONT ROVER DEVCE Q1 a ↑

CONT (F1)

To accept changes and return to the screen from where this screen was accessed.

ROVER (F2)

To configure additional settings relevant to rover operations. Refer to paragraph "CONFIGURE Additional Rover Options, General page". Available unless a SBAS data format has been selected for **<R-Time Data:>**. Refer to "22.3.6 Configuration of SBAS" for information on SBAS.

SRCH (F4)

Available on RX1250 with **<Port: Bluetooth x>** and a Bluetooth device being selected. To search for all available Bluetooth devices. If more than one Bluetooth device is found a list of available devices is provided.

DEVCE (F5)

To create, select, edit or delete a device. Refer to "23.2 Accessing CONFIGURE Devices / CONFIGURE GPRS Internet Devices". Available unless a SBAS data format has been selected for **<R-Time Data:>**. Refer to "22.3.6 Configuration of SBAS" for information on SBAS.

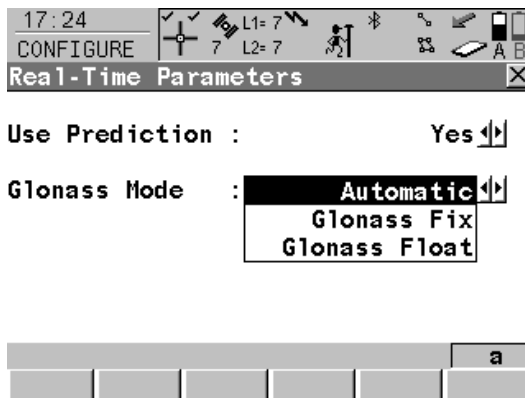
**SHIFT PARA (F3)**

To activate and deactivate the prediction of real-time observations between the data rate of the reference. Refer to paragraph "Prediction" for information on prediction. Available unless **<R-Time Data: RTCM 1,2 v2>** or **<R-Time Data: RTCM 9,2 v2>**.

Define if **GLONASS** observations are fixed or not in an RTK solution or whether the sensor automatically decides (only **GLONASS** receivers).

SHIFT FILT (F4)

To activate and deactivate the height filter for height smoothing. Refer to paragraph "Height smoothing" for information on height smoothing. Available unless a SBAS data format has been selected for **<R-Time Data:>**. Refer to "22.3.6 Configuration of SBAS" for information on SBAS.

SHIFT SBAS (F5)

To configure the **Space-Based Augmentation System** to be used. The configuration of SBAS determines the options available for **<R-Time Data:>** in **CONFIGURE Real-Time Mode**. Refer to "22.3.6 Configuration of SBAS".



Two real-time devices can be attached to two different ports, for example a radio and a digital cellular phone. Due to the nature of a rover, the two devices cannot operate simultaneously. It is recommended to choose two different configuration sets, one for each real-time device. Change the configuration set to change the active device.

Description of fields

Field	Option	Description
<R-Time Mode:>	None, Reference or Rover	<R-Time Data: Rover> activates a rover real-time interface.
<R-Time Data:>	Leica CMR/CMR+ RTCM v3 RTCM 1,2 v2 RTCM 9,2 v2 RTCM 18,19 v2 RTCM 20,21 v2 WAAS/EGNOS/M SAS, EGNOS, WAAS, MSAS, EGNOS (Test) or WAAS (Test)	Refer to "22.3.3 Configuration of a Reference Real-Time Interface" for information about these real-time data formats. The availability of the following options depend on the selection made for <SBAS Tracking:> in CONFIGURE SBAS Tracking Mode . Refer to "22.3.6 Configuration of SBAS". Wide Area Augmentation System European Geostationary Navigation Overlay Service MTSAT Satellite-based Augmentation System where MTSAT stands for Multi-functional Transport SATellite .

Field	Option	Description
<Port:>	Bluetooth x	Available for RX1250. The Bluetooth port which will be used for the interface functionality.
	Clip-on	Available for RX1250. The clip-on-contacts. It is used for RX1250 with GHT56 when a device is attached to the GHT56.
	NETx	Available for an activated Internet interface. If these ports are not assigned to a specific interface, then these ports are additional remote ports.
	Port x	The physical port P1, P2 or P3 on the instrument to which the device is attached.
<ID Address:>	Output	Available on RX1250 with <Port: Bluetooth x > and a Bluetooth device being selected. The ID address of the SmartAntenna to be used.
<Ref Sensor:>	Choicelist	The receiver type used at the reference. If the real-time data format does not contain the information of the receiver type certain corrections based on the information of the receiver type are applied in order to provide correct results. The real-time data formats Leica , CMR and CMR+ contain this information. This is mainly important when a System300 receiver is used as reference.

Field	Option	Description
<Ref Antenna:>	Choicelist	<p>The antenna used at the reference. If the real-time data format does not contain the information of the antenna certain corrections based on the information of the antenna are applied in order to provide correct results. The real-time data formats Leica, RTCM v2.3, CMR and CMR+ contain this information.</p> <p> If the reference data is corrected by absolute antenna calibration values and a Leica standard antenna is being used on the rover, select ADVNULLANTENNA as reference antenna.</p>

Next step

IF additional rover options	THEN
are not to be configured	CONT (F1) closes the screen and returns to the screen from where CONFIGURE Real-Time Mode was accessed.
are to be configured	ROVER (F2) . Refer to paragraph "CONFIGURE Additional Rover Options, General page".

**CONFIGURE
Additional Rover
Options,
General page**

The available fields depend on the selected <R-Time Data:> in **CONFIGURE Real-Time Mode**.

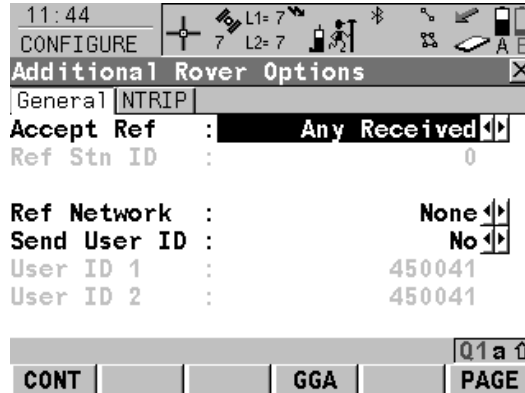

CONT (F1)

To accept changes and return to the screen from where this screen was accessed.

GGA (F4)

To activate the sending of a GGA message for reference network applications. Refer to "22.3.7 Configuration of GGA Message Sending for Reference Network Applications".

GETID (F5)

Available for <Accept Ref: User Defined>. To display and select the station ID of the available reference stations, the latency of the message and the data format. When using radios, the radio channel can be switched and the stations received on the new frequency are displayed.

1st (F6)

Available for <Accept Ref: First Received>. To force the system to try to establish a new connection with a different reference station.

PAGE (F6)

To change to another page on this screen.

Description of fields

Field	Option	Description
<Accept Ref:>	User Defined	The reference station of which real-time data is to be accepted. Incoming real-time data is accepted from the reference station defined in <Ref Stn ID:>.
	First Received	Incoming real-time data from the first recognised reference station is accepted.
	Any Received	Incoming real-time data from any reference station is accepted.
<Ref Stn ID:>	User input	Available for <Accept Ref: User Defined>. The special ID of the reference station from which real-time data is to be received. The allowed minimum and maximum values vary.
	From 0 to 31	For <R-Time Data: Leica> and <R-Time Data: CMR/CMR+>.
	From 0 to 1023	For <RTCM Version: 1.x> and <RTCM Version: 2.x>.
	From 0 to 4095	For <R-Time Data: RTCM v3>.
<Ref Network:>		Defines the type of reference network to be used. Refer to LEICA GPS Spider documentation for more detailed descriptions.
	None	To survey without reference station network.

Field	Option	Description
	Nearest	<p>The rover sends its position via NMEA GGA message to LEICA GPS Spider. From this position, LEICA GPS Spider determines the reference in a reference network that is closest to the rover. The corrections from that reference is sent to the rover. Supported for all real-time data formats.</p> <p>If this option is selected, a NMEA GGA message must be activated using GGA (F4). Refer to "22.3.7 Configuration of GGA Message Sending for Reference Network Applications".</p>
	i-MAX	<p>individualised Master-AuXiliary corrections.</p> <p>The rover sends its position via NMEA GGA message to LEICA GPS Spider where the Master-Auxiliary corrections are calculated. The corrections are also individualised by LEICA GPS Spider, which means it determines the best suitable corrections for that rover.</p> <p>The corrections are sent in Leica, RTCM v2.3 or RTCM v3 with message types 1015/1016.</p> <p>If this option is selected, a NMEA GGA message can be activated using GGA (F4). Refer to "22.3.7 Configuration of GGA Message Sending for Reference Network Applications".</p>

Field	Option	Description
	MAX	<p>Master-AuXiliary corrections The rover typically does not send its position to LEICA GPS Spider. LEICA GPS Spider calculates and sends Master-Auxiliary corrections to the rover. The rover individualises the corrections for its position, which means it determines the best suitable corrections. The corrections are sent in RTCM v3 with message types 1015/1016.</p> <p>If this option is selected, a NMEA GGA message can be activated using GGA (F4). Refer to "22.3.7 Configuration of GGA Message Sending for Reference Network Applications".</p>
	VRS	<p>Virtual Reference Station. If this option is selected, a NMEA GGA message must be activated using GGA (F4). Refer to "22.3.7 Configuration of GGA Message Sending for Reference Network Applications".</p>
	FKP	<p>Area correction parameters. Derived from German: FlächenKorrektur Parameter</p>
<Send User ID:>	Yes or No	Activates the sending of a Leica proprietary NMEA message defining the user.
<User ID 1:> and <User ID 2:>	User input	Available for <Send User ID: Yes> . The specific user ID's to be sent as part of the Leica proprietary NMEA message. By default the serial number of the instrument is displayed.

Field	Option	Description
<RTCM Version:>	1.x, 2.1, 2.2 or 2.3	Available for <R-Time Data: RTCM XX v2> in CONFIGURE Real-Time Mode . The same version must be used at the reference and the rover.
<Bits / Byte:>	6 or 8	Defines the number of bits/byte in the RTCM message being received.

Next step

PAGE (F6) changes to the **NTRIP** page.

**CONFIGURE
Additional Rover
Options,
NTRIP page**

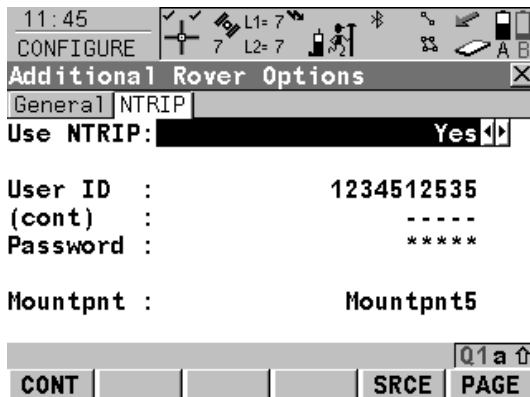

CONT (F1)

To accept changes and return to the screen from where this screen was accessed.

SRCE (F5)

To download the NTRIP source table if <Mountpnt:> is unknown. To do this, the GPRS Internet interface must already be configured. Refer to "34.2.3 Using the NTRIP Service with a Real-Time Rover".

PAGE (F6)

To change to another page on this screen.

Description of fields

Field	Option	Description
<Use NTRIP:>	Yes or No	Activates NTRIP.
<User ID:>	User input	A user ID is required to receive data from the NTRIP Caster. Contact the NTRIP administrator for information.
<(cont):>	User input	Allows the <User ID:> string to continue onto a new line.
<Password:>	User input	A password is required to receive data from the NTRIP Caster. Contact the NTRIP administrator for information.
<Mountpnt:>	User input	The NTRIP Source from where real-time data is required.

Next step

Step	Description
1.	CONT (F1) returns to CONFIGURE Real-Time Mode .
2.	CONT (F1) returns to the screen from where CONFIGURE Real-Time Mode was accessed.

Prediction

The following provides additional information on the prediction of real-time positions between the data rate of the reference. This can be activated for a real-time rover interface unless **<R-Time Data: RTCM 1,2 v2>** or **<R-Time Data: RTCM 9,2 v2>**.

Access

SHIFT PRED (F3) in **CONFIGURE Real-Time Mode**.

Description

Prediction is the interpolation of real-time corrections between those regularly transmitted by a reference at a defined data rate.

Advantages in using prediction

- Computation of real-time positions on the rover is independent from the transmission rate of the data from the reference station.
- Positions computed with prediction have a reduced latency of around 20 ms.

Recommended settings for using prediction

The slower the data rate the more important it is to activate prediction.

Height smoothing

The following provides additional information on the height filter for height smoothing. This can be activated for a real-time rover interface unless **<R-Time Data: WAAS/EGNOS/MSAS>**.

Access

SHIFT FILT (F4) in **CONFIGURE Real-Time Mode**.

Description

Height smoothing is a filter applied to all heights measured in the WGS 1984 or a local coordinate system or output via NMEA. The filter defaults are best suited for high dynamic variations in height up to 1 m/s as carried out by graders.

Height Smoothing with high dynamic GPS operations

All GPS computed positions are almost twice as accurate in plan than in height. For the position determination, satellites can appear in all four quadrants. For the height determination, satellites can appear in two quadrants. This weakens the height position compared to the plan position.

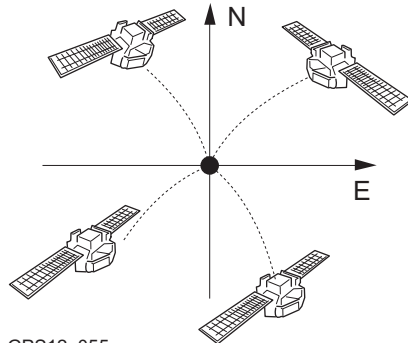

GPS12_055

Position determination with satellites appearing in all four quadrants.

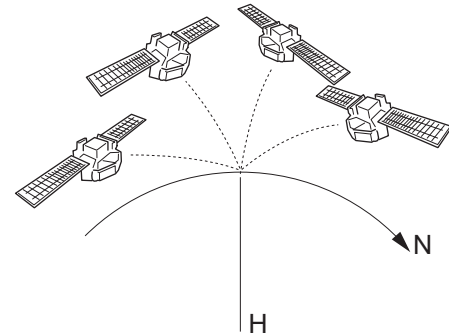

Height determination with satellites appearing in two quadrants.

In high dynamic GPS operations, this fact results in height variations of a few centimetres as shown in the blue curve in the diagram below. Some GPS monitoring applications require a stabilised height. By applying the filter, the height variations are smoothed and most of the noise in the height component is eliminated.

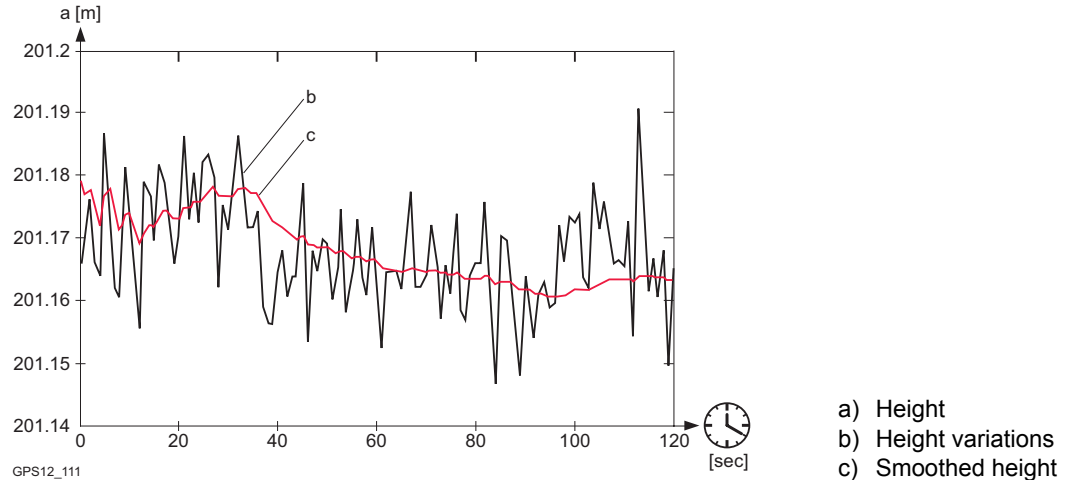

22.3.5

Configuration with Digital Cellular Phone and Radio

Description

An ideal real-time setup is to combine a radio and a digital cellular phone to get the best of both technologies. The radio can be used where the radio signals can be received, the advantage being that the radio data transmission is free. If the radio link is broken when the rover goes out of range or due to an obstruction, change to the digital cellular phone to complete the survey. This allows maximum productivity and minimal costs with real-time GPS.

Field procedure step-by-step

Step	Description
1.	Set up a reference.
2.	On the reference, attach a digital cellular phone to one port and a radio to another port.
3.	Configure both interfaces on the reference.
4.	Start the reference. Real-time data is transmitted on two ports simultaneously - using different devices.
5.	Set up a rover.
6.	On the rover, attach a digital cellular phone to one port and a radio to another port.
7.	Use two configuration sets to configure both interfaces on the rover.
8.	Start the rover using either the digital cellular phone interface or the radio interface.
9.	On the rover, change the configuration set in use in order to change between using digital cellular phone and radio. There is no need to return to the reference.

22.3.6

Configuration of SBAS

Description

Allows a **Space-Based Augmentation System** to be configured to provide additional corrections in conjunction with GPS signals. Also commonly referred to as **Satellite-Based Augmentation System**, SBAS provides corrected time and distance measurements calculated by a network of ground relay stations and geostatic satellites. A SBAS can correct for problems such as atmospheric delays, poor satellite geometry and incorrect satellite positioning.

Access step-by-step

Step	Description
1.	Refer to "22.3.1 Overview" to access CONFIGURE Real-Time Mode .
2.	SHIFT SBAS (F5) to access CONFIGURE SBAS Tracking Mode .

CONFIGURE SBAS Tracking Mode

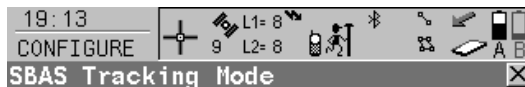

SBAS Tracking: **Automatic SBAS** ⏪ ⏩



CONT (F1)

To accept changes and return to the screen from where this screen was accessed.

Description of fields

Field	Option	Description
<SBAS Tracking:>		The Space-Based Augmentation System to use. The options available for < R-Time Data > in CONFIGURE Real-Time Mode depend on the selection made here.
	Automatic SBAS	SBAS satellites will be tracked and the SBAS service used will be automatically selected, including MSAS.
	WAAS	Wide Area Augmentation System satellites will be tracked.
	EGNOS	European Geostationary Navigation Overlay System satellites will be tracked.
	MSAS	MTSAT Satellite-based Augmentation System where MTSAT stands for Multi-functional Transport SATellite
	EGNOS (Test)	To track European Geostationary Navigation Overlay System satellites while the system is still in test mode.
	WAAS (Test)	To track Wide Area Augmentation System satellites while the system is still in test mode.

Next step

Step	Description
1.	CONT (F1) returns to CONFIGURE Real-Time Mode .

Step	Description
2.	CONT (F1) returns to the screen from where CONFIGURE Real-Time Mode was accessed.

22.3.7

Configuration of GGA Message Sending for Reference Network Applications

Description

Most reference networks require an approximate position of the rover. For reference network applications, a rover dials into the reference network and submits its approximate position in form of a NMEA GGA message.

By default, the receiver sends GGA messages with updated current positions automatically when a reference network is selected.

Surveying regulations in some countries require that one certain position can be selected. This position is then sent to the reference network as GGA message through the real-time interface every five seconds.

Refer to "F.3 GGA - Global Positioning System Fix Data" for information on GGA message format.

Access step-by-step

Step	Description
1.	Refer to "22.3.1 Overview" to access CONFIGURE Real-Time Mode .
2.	ROVER (F2) to access CONFIGURE Additional Rover Options .
3.	GGA (F5) to access CONFIGURE Send GGA NMEA .

OR

Press a hot key configured to access the screen **CONFIGURE Send GGA NMEA**. Refer to "6.1 Hot Keys" for information on hot keys.

OR

Press **USER**. Refer to "6.2 USER Key" for information on the **USER** key.

CONFIGURE

Send GGA NMEA

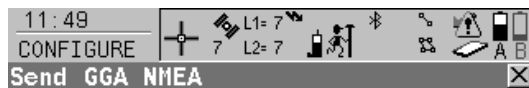

GGA Position : **LAST/HERE Posn**

Easting : 760300.361 m
 Northing : 254925.548 m
 Local Ell Ht : 455.948 m



CONT (F1)

To accept changes and return to the screen from where this screen was accessed.

COORD (F2)

Available for <GGA Position: From Job> and <GGA Position: LAST/HERE Posn>. To view other coordinate types. Local coordinates are available when a local coordinate system is active.

LAST (F3)

Available for <GGA Position: LAST/HERE Posn>. To use the same coordinates in the GGA message as when the receiver was last used in a reference network application. This is possible when position coordinates from a previous reference network application are still stored in the System RAM.

HERE (F4)

Available for <GGA Position: LAST/HERE Posn>. To use the coordinates of the current navigation position in the GGA message.

SHIFT ELL H (F2) and SHIFT ORTH (F2)

To change between the ellipsoidal and the orthometric height. Available for local coordinates.

Description of fields

Field	Option	Description
<GGA Position:>	Automatic	The current rover position is sent to the reference network. The position is updated and sent every five seconds.
	From Job	A point from the active job can be selected in <Point ID:>. The position of this point is sent to the reference network every five seconds.
	LAST/HERE Posn	The position last used in a reference network application or the current navigation position can be selected using LAST (F3) or HERE (F4) . The selected position is sent every five seconds.
	None	No GGA message is sent to the reference network.
<Point ID:>	Choicelist	Available for <GGA Position: From Job>. The coordinates of this point are sent out in the GGA message. Opening the choicelist opens MANAGE Data: Job Name . Refer to "9.2 Accessing Data Management".

Next step

Step	Description
1.	CONT (F1) returns to CONFIGURE Additional Rover Options .
2.	CONT (F1) returns to CONFIGURE Real-Time Mode .

Step	Description
3.	CONT (F1) returns to the screen from where CONFIGURE Real-Time Mode was accessed.

22.4

22.4.1

ASCII Input

Overview

Description

The ASCII Input interface receives ASCII messages from third party devices such as depth sounders, barometers, digital cameras, pipe detectors, Geiger counters, etc. The ASCII messages are stored as point annotations together with the next manually occupied point and/or auto point. After receiving the ASCII message, a reply can be sent back to the device as confirmation.

The settings on this screen define the port and the device to be used and the type of ASCII messages to be written to individual annotations.

Access

Select **Main Menu: Config...Interfaces...**. Highlight **ASCII Input. EDIT (F3)**.

Next step

IF the task is to configure the	THEN
ASCII interface	Refer to "22.4.2 Configuration of an ASCII Input Interface".
annotations	Refer to "22.4.3 Configuration of Annotations".
reply command	Refer to "22.4.4 Configuration of a Command to the Device".

22.4.2

Configuration of an ASCII Input Interface

Access

Refer to "22.4.1 Overview" to access **CONFIGURE ASCII Input**.

CONFIGURE
ASCII Input

11:51
CONFIGURE
ASCII Input
Use Device : Yes
Port : Port 3
Device : RS232
End of Msg : CR
Annotation 1 : Depth sounder
Annotation 2 : -----
Annotation 3 : -----
Annotation 4 : Seismic
CONT ANNOT DEVE Q1 a ↑

CONT (F1)

To accept changes and return to the screen from where this screen was accessed.

ANNOT (F2)

To configure which ASCII messages to record to which annotation. Refer to "22.4.3 Configuration of Annotations".

DEVE (F5)

Available unless **<Device: NETx>**. To create, select, edit or delete a device. Refer to "23.2 Accessing CONFIGURE Devices / CONFIGURE GPRS Internet Devices".

SHIFT CMND (F5)

To configure a message to be sent through the configured port to the device. Refer to "22.4.4 Configuration of a Command to the Device".

Description of fields

Field	Option	Description
<Use Device:>	Yes or No	Activates the ASCII input interface.
<Port:>	Bluetooth x	Available for RX1250. The Bluetooth port which will be used for the interface functionality.

Field	Option	Description
	NETx	Available for an activated Internet interface. If these ports are not assigned to a specific interface, then these ports are additional remote ports.
	Port x	The physical port P1, P2 or P3 on the instrument to which the device is attached.
	Port 1	Available for RX1250. LEMO port on RX1250.
<End of Msg:>	CR, LF or CR/LF	The character to be used to identify the end of the incoming ASCII message.
From <Annotation 1:> to <Annotation 4:>	Output	The description of the ASCII input as configured with ANNOT (F2) . If the seismic record is configured to be used then the default is <Annotation 4: Seismic> .

Next step

CONT (F1) returns to the screen from where **CONFIGURE ASCII Input** was accessed.

22.4.3

Configuration of Annotations

Configuration of annotations step-by-step

Step	Description
1.	Refer to "22.4.1 Overview" to access CONFIGURE ASCII Input .
2.	ANNOT (F2) to access CONFIGURE Annotations to be Used .
3.	<p>CONFIGURE Annotations to be Used</p> <p><Annotation:> The annotation to which the ASCII message is to be stored.</p> <p><Accept ASCII:> Activates the recording of ASCII messages with the selected annotation. <Accept ASCII: No> if the seismic record is configured to be used with <Annotation: Annotation 4>.</p> <p><Message Desc:> The description for the ASCII message being received. This description is then displayed in other screens, e.g. in STATUS ASCII Input - XX.</p> <p><Message ID:> The message ID to identify a particular ASCII message coming from the device. The message is then saved to the annotation. Refer to "22.4.2 Configuration of an ASCII Input Interface". The following characters can be used as filter:</p> <p>^ To accept strings starting with the subsequent characters. For example ^1 accepts 12 but not 21.</p> <p>\$ To accept strings ending with the preceding characters. For example 1\$ accepts 21 but not 12.</p> <p>. To accept any character except newline.</p> <p>[] To accept a set of characters. For example [0-9] accepts all numbers.</p>

Step	Description
	<p>Any characters to accept strings that include the characters at any position. For example 1 accepts 1234, 4321 or 2134 but not 2345.</p> <p><Use Prefix:> Stores the description in <Message Desc:> as prefix to the ASCII message. This helps to more easily identify the annotations registered with a point.</p> <p><Send Reply:> As a reaction of the receiver to an incoming ASCII message, an NMEA message can be sent back to the device. For example, in the case of a camera this allows the position to be integrated into the photograph afterwards.</p> <p>Adapt the settings for a selected annotation according to the requirements.</p>
4.	For the configuration of other annotations repeat step 3. until all annotations are configured.
5.	CONT (F1) stores the changes and returns to CONFIGURE ASCII Input .

22.4.4

Configuration of a Command to the Device

Configuration of command step-by-step

Step	Description
1.	Refer to "22.4.1 Overview" to access CONFIGURE ASCII Input .
2.	SHIFT CMND (F5)
3.	CONFIGURE Send Command to Device <Command:> A message to be sent to the device through the configured port when the survey or stakeout application program is accessed. This, for example, allows the device to be started remotely. The last used command that was entered is remembered as part of the active configuration set. Type in the command to be sent.
4.	SEND (F3) sends the command to the device.
5.	CONT (F1) returns to CONFIGURE ASCII Input .

22.4.5

Working Example 1

Description

Application:	Survey on a small lake. Recording the depth with the survey points.
Working technique:	Using a depth sounder to measure the depth of the lake at certain locations.
Goal:	The depth sounder constantly streams data at a rate of 1 Hz and sends the depth it has measured to the GPS1200 receiver in the format: 27.234<CR> 27.345<CR> 27.232<CR> The ASCII Input interface needs to be configured such that when a position is measured, the depth measurement will be stored as annotation 1 with that point.

Requirements

The port and the device to be used for the depth sounder is configured correctly. The device will most likely be RS232 using the same parameters as the depth sounder. Refer to "23.2 Accessing CONFIGURE Devices / CONFIGURE GPRS Internet Devices".

Configuration of ASCII Input interface step-by-step

Step	Description
1.	Refer to "22.4.1 Overview" to access CONFIGURE ASCII Input .

Step	Description
2.	CONFIGURE ASCII Input <Use Device: Yes> <Port:> Select the port to which the depth sounder is connected. <End of Msg: CR>
3.	ANNOT (F2)
4.	CONFIGURE Annotations to be Used <Annotation: Annotation 1> <Accept ASCII: Yes> <Message Desc: Depth Sounder> <Message ID: -----> <Use Prefix: None> <Send Reply: No>
5.	Still in CONFIGURE Annotations to be Used <Annotation: Annotation 2> <Accept ASCII: No>
6.	Repeat step 5. for <Annotation: Annotation 3> and <Annotation: Annotation 4>.
7.	CONT (F1) closes the screen and returns to CONFIGURE ASCII Input .
8.	CONT (F1) returns to the screen from where CONFIGURE ASCII Input was accessed.

Field procedure step-by-step

Step	Description
1.	The coordinates of points can be measured over the lake with the depth of the lake at that point recorded as an annotation. Refer to "44 Survey - General" for information on how to run a survey.
	Because the depth sounder is streaming data, the depth measurement that is stored with the point is the last measurement received by the receiver before the point is stored. The point can be stored manually or automatically. Refer to "19.6 Point Occupation Settings" for information on how to configure <Auto STORE:> .



The coordinates of the points can be measured as auto points. Refer to "45 Survey - Auto Points" for information on how to automatically log points.



Use **STATUS ASCII Input - XX** to view and check the ASCII data being input to the receiver. Refer to "31.5.1 Real-Time Input".

22.4.6**Working Example 2**

Description

Application:	Survey on contaminated waste land. Recording four different levels of different gasses with the surveyed points.
Working technique:	Using a gas analyser to measure the levels of gasses at various locations.
Goal:	<p>The gas analyser outputs the results as an ASCII message and sends the four different levels it has measured to the GPS1200 receiver in the format:</p> <pre>GS1 2.786<CR/LF> GS2 0.034<CR/LF> GS3 1.395<CR/LF> GS4 0.025<CR/LF></pre> <p>GS1 to GS4 is the message ID for the four different gasses. The numbers are the gas reading in ppm. The ASCII Input interface needs to be configured such that when a position is measured, the ASCII message is split and that each individual gas reading is recorded as a separate annotation. For example, annotation 1 would contain the value 2.786, annotation 2 would contain the value 0.034 etc. The message ID is used to “search” the input for that particular gas reading.</p>

Requirements

The port and the device to be used for the gas analyser is configured correctly. The device will most likely be RS232 using the same parameters as the depth sounder. Refer to "23.2 Accessing CONFIGURE Devices / CONFIGURE GPRS Internet Devices".

Configuration of ASCII Input interface step-by-step

Step	Description
1.	Refer to "22.4.1 Overview" to access CONFIGURE ASCII Input .
2.	CONFIGURE ASCII Input <Use Device: Yes> <Port:> Select the port to which the depth sounder is connected. <End of Msg: CR/LF>
3.	ANNOT (F2)
4.	CONFIGURE Annotations to be Used <Annotation: Annotation 1> <Accept ASCII: Yes> <Message Desc: Gas 1> <Message ID: GS1> <Use Prefix: None> <Send Reply: No>
5.	Still in CONFIGURE Annotations to be Used <Annotation: Annotation 2> <Accept ASCII: Yes> <Message Desc: Gas 2>

Step	Description
	<Message ID: GS2> <Use Prefix: None> <Send Reply: No>
6.	Repeat step 5. accordingly for <Annotation: Annotation 3> and <Annotation: Annotation 4>.
7.	CONT (F1) closes the screen and returns to CONFIGURE ASCII Input .
8.	CONT (F1) returns to the screen from where CONFIGURE ASCII Input was accessed.

Field procedure

The coordinates of the points can be measured. Before storing each point, the gas analyser is activated to take a gas reading at the point. The point can then be stored and the four gas readings are stored as individual annotations along with each point. Refer to "44 Survey - General" for information on how to run a survey.

22.5

NMEA Out

Description

National Marine Electronics Association has developed a message standard related to the marine electronics industry. NMEA messages have been accepted as the standard for sharing specific data information between companies since the late 1970s. Refer to "Appendix F NMEA Message Formats" for a comprehensive description of each NMEA message.

The settings on this screen define the port, the device and the type of NMEA message to be used for the NMEA Out interface.

Up to two NMEA Out interfaces can be configured. Each NMEA Out interface can output different messages at different rates with different talker ID's. The output of NMEA messages on both ports is simultaneous.

The screens for the configuration of both NMEA interfaces are identical except for the title - **NMEA Output 1** and **NMEA Output 2**. For simplicity, the title **NMEA Output** is used in the following.

Access

Select **Main Menu: Config...Interfaces....** Highlight **NMEA Out. EDIT (F3)**.



NMEA Out 2 is not available for RX1250 with SmartAntenna.

**CONFIGURE
NMEA Output**

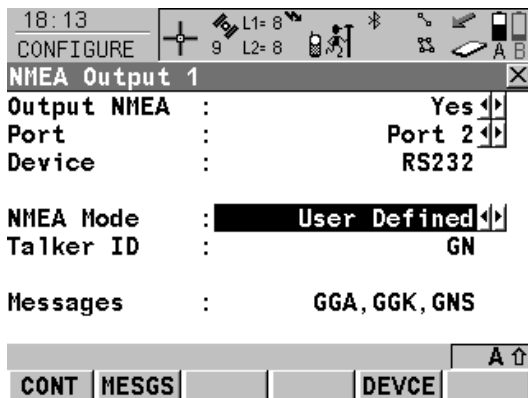

CONT (F1)

To accept changes and return to the screen from where this screen was accessed.

MESGS (F2)

To configure what NMEA messages are output, the rates and the output timing method. Refer to paragraph "CONFIGURE NMEA Messages".

DEVICE (F5)

Available unless **<Port: NETx>**. To create, select, edit or delete a device. Refer to "23.2 Accessing CONFIGURE Devices / CONFIGURE GPRS Internet Devices".

Description of fields

Field	Option	Description
<Output NMEA:>	Yes or No	Activates the output of NMEA.
<Port:>	Bluetooth x	Available for RX1250. The Bluetooth port which will be used for the interface functionality.
	NETx	Available for an activated Internet interface. If these ports are not assigned to a specific interface, then these ports are additional remote ports.
	Port x	The physical port P1, P2 or P3 on the instrument to which the device is attached.
	Port 1	Available for RX1250. LEMO port on RX1250.

Field	Option	Description
<Device:>	Output	Usually, RS232 is used to transfer NMEA messages.
<NMEA Mode:>	Standard or User defined	The NMEA Talker ID based on the NMEA standards v3.0 or user defined input.
<Talker ID:>	User input	Available for <NMEA Mode: User defined> . Appears at the beginning of each NMEA message. Normally, this will remain at the default GP for GPS. Refer to "F.1 Overview" for more information.
<Messages:>	Output	The NMEA messages currently selected for output. Refer to "Appendix F NMEA Message Formats" for more information.

Next step

IF NMEA messages	THEN
are not configured	CONT (F1) closes the screen and returns to the screen from where CONFIGURE NMEA Output was accessed.
are to be configured	MESGS (F2) . Refer to paragraph "CONFIGURE NMEA Messages".

**CONFIGURE
NMEA Messages**

This screen shows the messages that can be output, which messages are currently output, the output rates and the output timing method.

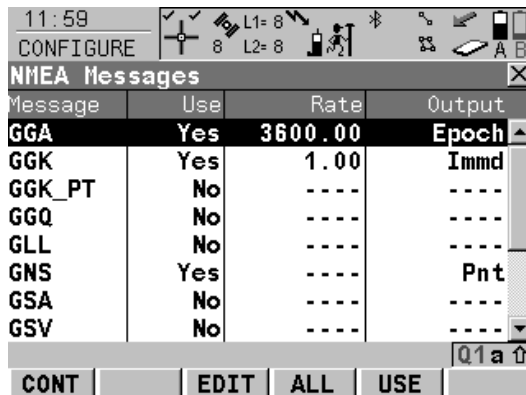

CONT (F1)

To accept changes and return to the screen from where this screen was accessed.

EDIT (F3)

To configure how the currently highlighted message is output. Refer to paragraph "CONFIGURE Message to Send".

ALL (F4) and NONE (F4)

To activate and deactivate the output for all messages.

USE (F5)

To activate and deactivate the output for the highlighted message.

Next step

IF a NMEA message	THEN
is not to be configured	CONT (F1) closes the screen and returns to the screen from where CONFIGURE NMEA Messages was accessed.
is to be configured	highlight the message and EDIT (F3) . Refer to paragraph "CONFIGURE Message to Send".

CONFIGURE Message to Send

12:01

CONFIGURE

NMEA Message to Send

NMEA Message : GGA

Use Message : **Yes**

Output : At Epoch

Output Delay : 0.0 sec

Rate : 3600.0s

CQ Control : None

Maximum CQ : 0.050 m

Q1a ↑

CONT

CONT (F1)

To accept changes and return to the screen from where this screen was accessed.

Description of fields

Field	Option	Description
<Output:>	At Epoch	The NMEA message is created at the exact epoch as defined in <Position and Screen Update:> in CONFIGURE Display Settings . It is sent out in the time interval as defined in <Rate:>. With <Output Delay:>, the output can also be delayed by a time after this epoch. Refer to paragraph "Diagram".
	Immediately	The NMEA message is created as soon as the information is available. It is sent out in the time interval as defined in <Rate:>. Refer to paragraph "Diagram".
	On Point Stored	The NMEA message is sent on point storage.

Field	Option	Description
		 If the time interval as defined in <Rate:> is shorter than the epochs as defined in <Position and Screen Update:> in CONFIGURE Display Settings , then the internal computation of positions is changed to allow the specified rate of NMEA positions. <Position and Screen Update:> remains unchanged.
<Output Delay:>	User input	<p>Available for <Output: At Epoch>. Delays the output of the NMEA message. The delay is applied from the epoch as defined in <Rate:>. The time of delay can be a value up to <Rate:>.</p> <p>This option is required if two or more receivers are being used to monitor the position of an object. The position of each receiver is being output as NMEA message back to a control station. The control station may not be able to cope with all the positional data messages if all receivers were sending their position message back at exactly the same time as would be the case with <Output: Immediately>. In this case the output of the second receiver could be delayed so that the control station receives the message from each receiver at a slightly different time.</p>
<Point Type:>		<p>Available for <Output: On Point Stored>. Defines the type of points for which the NMEA message is send.</p>

Field	Option	Description
	All Points Occupy Pts Only Auto Pts Only	<p>The NMEA message is sent when any type of point is stored.</p> <p>The NMEA message is sent when a manually occupied point is stored.</p> <p>The NMEA message is sent when auto points are stored.</p>
<Rate:>	From 0.05s to 3600.0s	Available unless <Output: On Point Stored>. Defines the time intervals at which the NMEA messages are created. The maximum rate using Bluetooth on RX1250 is 0.2 s.
<CQ Control:>	None, Pos Only, Height Only or Pos & Height	Available unless <Output: On Point Stored>. Activates a control over the coordinate quality. NMEA messages are not output, if the coordinate quality of the position and/or height component exceeds the limit as defined in <Maximum CQ:>.
<Maximum CQ:>	User input	Available unless <CQ Control: None>. The limit for the coordinate quality up to which NMEA messages are output.

Next step

Step	Description
1.	CONT (F1) returns to CONFIGURE NMEA Messages .

Step	Description
2.	CONT (F1) returns to the screen from where CONFIGURE NMEA Messages was accessed.

Diagram

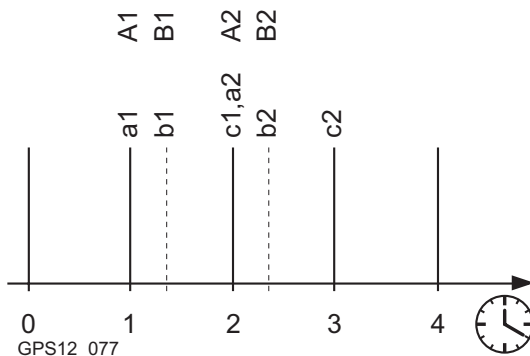

For **<Output: At Epoch>** with **<Rate: 1.0s>** and **<Position and Screen Update: 1.0s>**

- a1 Data 1 available
- b1 NMEA message for data 1 composed
- c1 NMEA message for data 1 sent
- a2 Data 2 available
- b2 NMEA message for data 2 composed
- c2 NMEA message for data 2 sent

For **<Output: Immediately>** with **<Rate: 1.0s>** and **<Position and Screen Update: 1.0s>**

- A1 Data 1 available
- B1 NMEA message for data 1 composed and sent
- A2 Data 2 available
- B2 NMEA message for data 2 composed and sent

22.6

Export Job

Description

The Export Job interface allows data from a job to be exported from the receiver to an instrument such as Leica TPS400/700. Refer to "16.4 Exporting Data from a Job to another Device" for information on how to export data via RS232.

The settings on this screen define the port and the device to which the data should be exported.

Access

Select **Main Menu: Config...\Interfaces....** Highlight **Export Job. EDIT (F3)**.

OR

Select **Main Menu: Convert...\Export Data from Job**. Set **<Export To: RS232>. IFACE (F5)**.

CONFIGURE

Export Job Interface

The availability of the fields depend on the setting for **<Device:>**.

12:02
CONFIGURE
Export Job Interface
Use Device : Yes
Port : Port 1
Device : Leica TPS400/700
Job Number :
Name :
CONT GET DEVICE Q1a

CONT (F1)

To accept changes and return to the screen from where this screen was accessed.

GET (F4)

Available for **<Device: Leica TPS400/700>**. To check which jobs are available on the TPS400/700. The job numbers can then be selected in **<Job Number:>**.

DEVICE (F5)

To create, select, edit or delete a device. Refer to "23.2 Accessing CONFIGURE Devices / CONFIGURE GPRS Internet Devices".

Description of fields

Field	Option	Description
<Use Device:>	Yes or No	Activates the interface.
<Port:>	Bluetooth x	Available for RX1250. The Bluetooth port which will be used for the interface functionality.
	NETx	Available for an activated Internet interface. If these ports are not assigned to a specific interface, then these ports are additional remote ports.
	Port x	The physical port P1, P2 or P3 on the instrument to which the device is attached.
	Port 1	Available for RX1250. LEMO port on RX1250.
<Device:>	Output	The device currently assigned to the selected port within the active configuration set. The device which is selected determines the availability of the next fields.
<Job Number:>	From 1 to 8	The number of the job on the TPS400/700 to which the data will be sent.
<Job Name:>	Output or User input	Displays the name of an existing job assigned to the selected job number. If the selected job number does not yet have a job name assigned to it, enter a new job name. This job is then created on the TPS400/700 instrument.

Next step

CONT (F1) returns to the screen from where **CONFIGURE Export Job Interface** was accessed.

22.7

Hidden Point

Description

Hidden point measurement devices are used for measuring to points which cannot be directly measured with GPS, for example house corners or trees. The measurements made with a hidden point measurement device are directly transferred to the receiver for the calculation of the coordinates of the hidden point. They can also be entered manually.

The settings on this screen define the port, the device and estimated qualities to be used for the hidden point interface.



The configuration of hidden point measurements is possible for **<R-Time Mode: Rover>** and **<R-Time Mode: None>** in **CONFIGURE Real-Time Mode**.

Access

Select **Main Menu: Config...\Interfaces....** Highlight **Hidden Pt. EDIT (F3)**.

OR

Press **SHIFT CONF (F2)** in **HIDDEN PT Hidden Point Measurements**.

OR

Select **Main Menu: Survey**. In **SURVEY Survey Begin** press **CONF (F2)** to access **SURVEY Configuration**. **PAGE (F6)** until the **Hidden Points** page is active.

OR

In **SURVEY Survey: Job Name** press **SHIFT CONF (F2)** to access **SURVEY Configuration**. **PAGE (F6)** until the **Hidden Points** page is active.

CONFIGURE Hidden Point Measure- ments

Depending on the method of access, the name of the screen varies.

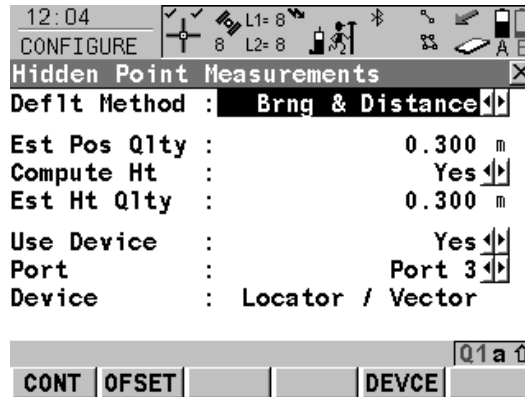

CONT (F1)

To accept changes and return to the screen from where this screen was accessed.

OFFSET (F2)

To configure the heighting and external angle offsets. Refer to paragraph "CONFIGURE Hidden Pt Device Offsets".

SRCH (F4)

Available on RX1250 with <Port: Bluetooth x> and a Bluetooth device being selected. To search for all available Bluetooth devices. If more than one Bluetooth device is found a list of available devices is provided.

DEVCE (F5)

To create, select, edit or delete a device. Refer to "23.2 Accessing CONFIGURE Devices / CONFIGURE GPRS Internet Devices".

Description of fields

Field	Option	Description
<Compute Ht:>	Yes or No	To compute a hidden point with height.
<Est Pos Qlty:>	User input	The estimated value for the position quality assigned to all hidden points. This must be estimated because hidden point measurement devices do not output position qualities.

Field	Option	Description
<Est Ht Qlty:>	User input	Available for <Compute Ht: Yes>. The estimated value for the height quality assigned to all hidden points.
<Use Device:>	Yes or No	Activates the hidden point interface. For <Use Device: No>, the measured values must be entered manually.
<Port:>	Bluetooth x	Available for RX1250. The Bluetooth port which will be used for the interface functionality.
	Port x	The physical port P1, P2 or P3 on the instrument to which the device is attached.
	Port 1	Available for RX1250. LEMO port on RX1250.

Next step

IF heighting and external angle offsets	THEN
are not to be configured	CONT (F1) closes the screen and returns to the screen from where CONFIGURE Hidden Point Measurements was accessed.
are to be configured	OFFSET (F2) . Refer to paragraph "CONFIGURE Hidden Pt Device Offsets".

**CONFIGURE
Hidden Pt Device
Offsets**

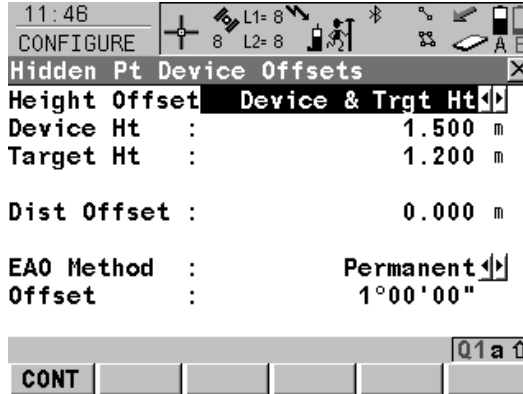

CONT (F1)

To accept changes and to return to
CONFIGURE Hidden Point Measurements.

Description of fields

Field	Option	Description
<Height Offset:>	None	Available for <Compute Ht: Yes> in CONFIGURE Hidden Point Measurements . No height offsets are used. The result is the delta height between the centre of the device and the aimed point. Refer to paragraph "Diagram".
	Device Ht	When measuring hidden points, the height of the hidden point measurement device can be typed in. This option should be used when the hidden point can be directly measured using the hidden point device. Refer to paragraph "Diagram".

Field	Option	Description
	Device & Trgt Ht	When measuring hidden points, the height of the hidden point measurement device as well as the target height can be typed in. This option should be used when the hidden point cannot be directly measured with a hidden point device but a target point can be used to calculate the position of the hidden point. Refer to paragraph "Diagram".
<Device Ht:>	User input	The height of the hidden point measurement device. This is the distance from the ground to the centre of the device. Refer to paragraph "Diagram".
<Target Ht:>	User input	The distance from the hidden point to the aimed point. Refer to paragraph "Diagram".
<Dist Offset:>	User input	The offset is automatically added to the measured distance. Refer to paragraph "Distance offsets at hidden point measurement devices".
<EAO Method:>	None	Sets the default method for entering an External Angle Offset . EAO is an offset angle between the North of the device being used and WGS 1984 geodetic North. EAO's are applied when measuring hidden points using a device capable of measuring azimuths. No EAO value is applied to the azimuth measurement received from the hidden point measurement device.

Field	Option	Description
	Permanent	Applies a default value for the offset angle. The value is changeable.
	New for Each Pt	Offset angle values must be entered for each new hidden point.
<Offset:>	User input	Available for <EAO Method: Permanent> . The default value for the offset angle.

Next step

Step	Description
1.	CONT (F1) returns to CONFIGURE Hidden Point Measurements .
2.	CONT (F1) returns to the screen from where CONFIGURE Hidden Point Measurements was accessed.

Diagram

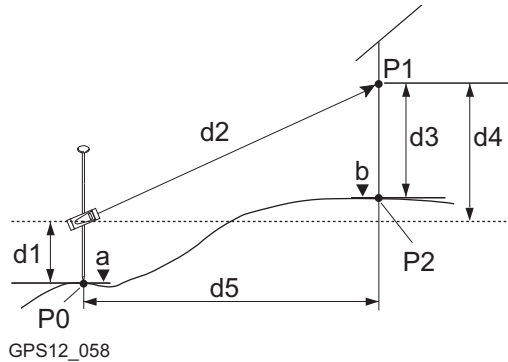

- P0 Known point
- P1 Target point
- P2 Hidden point
- a Height of P0
- b Height of P2 = $a + d1 + d4 - d3$
- d1 Device height: height of hidden point measurement device above P0
- d2 Slope distance
- d3 Device height: height of P1 above P2
- d4 Height difference between hidden point measurement device and P1
- d5 Horizontal distance

Distance offsets at hidden point measurement devices

A Leica Disto is shown as an example.

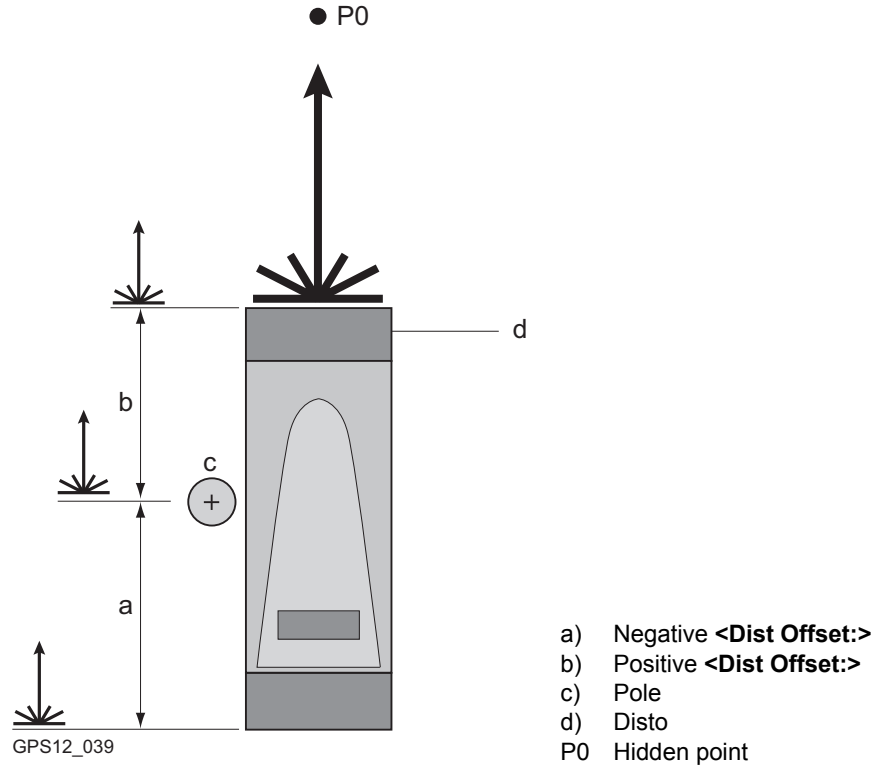

22.8

Tilt

Description

Tilt devices are used for measuring inclinations. The data from the tilt device is logged together with the GPS raw observations. PC based software can convert the tilt data to a readable ASCII format, e.g. RINEX.

In addition, a binary notification message can be output through ports P1, P2, P3, RX or NET to controlling application software. A port configured as a remote port can be used to output the notification message. The message contains the tilt measurements obtained by the receiver from the tilt device.

The settings on this screen define the input port and parameters for incoming tilt measurements.

Access

Select **Main Menu: Config...\Interfaces....** Highlight **Tilt**. **EDIT (F3)**.



This option is not available for RX1250 with SmartAntenna.

CONFIGURE Tilt Measurement

11:48

CONFIGURE

Tilt Measurement

Use Device : Yes

Port : Port 3

Device : Tilt NIVEL200

Data Rate : 1.0s

Log to File : Yes

Notify Msg : Binary

CONT NPORT DEVICE

CONT (F1)

To accept changes and return to the screen from where this screen was accessed.

NPORT (F4)

Available for **<Notify Msg: Binary>**. To configure the port and the device through which the notification message shall be transmitted. Refer to paragraph "CONFIGURE Choose Notification Port".

DEVICE (F5)

Available unless **<Port: NETx>**. To create, select, edit or delete a device. Refer to "23.2 Accessing CONFIGURE Devices / CONFIGURE GPRS Internet Devices".

Description of fields

Field	Option	Description
<Use Device:>	Yes or No	Activates the tilt interface.
<Data Rate:>	From 0.05s to 3600.0s	The rate at which data is requested from the tilt device.
<Log to File:>	Yes or No	To store measurements from the tilt device. Data is logged into the same job and file where the GPS raw observations are logged. No data is logged, unless raw observation logging is active. For an active ring buffer on a GRX1200 Classic, GRX1200 Pro or GRX1200 GG Pro, the measurements are also stored to the ring buffer files.

Field	Option	Description
<Notify Msg:>	None or Binary	Activates the output of a binary notification message. The format is LB2 v2. Documentation for LB2 is available on request from the Leica Geosystems representative.

Next step

IF port and device for a notification message	THEN
are not to be configured	CONT (F1) closes the screen and returns to the screen from where CONFIGURE Tilt Measurement was accessed.
are to be configured	NPORT (F4) to access CONFIGURE Choose Notification Port . Refer to paragraph "CONFIGURE Choose Notification Port".

CONFIGURE Choose Notification Port

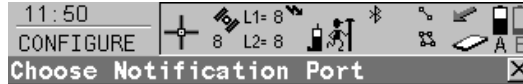

Port : **Port 2**
Device : **RS232**

CONT (F1)

To accept changes and return to the screen from where this screen was accessed.

DEVCE (F5)

Available unless **<Port: NETx>**. To create, select, edit or delete a device. Refer to "23.2 Accessing CONFIGURE Devices / CONFIGURE GPRS Internet Devices".



Description of fields

Field	Option	Description
<Port:>	Choicelist	The port through which the notification message shall be transmitted.
<Device:>	Output	The device that is currently configured to <Port:> . If no device is configured to that port then RS232 is displayed.

Next step

CONT (F1) returns to the screen from where **CONFIGURE Choose Notification Port** was accessed.

22.9

Meteo

Description

Meteo devices are used for measuring air pressure, temperature and relative humidity. The data from the meteo device is logged together with the GPS raw observations. PC based software can convert the meteo data to a readable ASCII format, e.g. RINEX. In addition, a binary notification message can directly be output through ports P1, P2, P3, RX or NET to controlling application software. A port configured as a remote port can be used to output the notification message. The message contains the meteo measurements obtained by the receiver from the meteo device.

The settings on this screen define the input port and parameters for incoming meteo measurements.

Access

Select **Main Menu: Config...\Interfaces....** Highlight **Meteo**. **EDIT (F3)**.



This option is not available for RX1250 with SmartAntenna.

CONFIGURE Meteo Measurement

The content of the screen is identical with for **CONFIGURE Tilt Measurement**. Refer to "22.8 Tilt" for an explanation.

22.10

SmartAntenna

Description

The SmartAntenna interface is used to send the measurement data from the SmartAntenna to the RX1250.

The settings on this screen define the port and the device through which a connection to the SmartAntenna should be established.



Establish connection automatically

The configuration of a SmartAntenna interface is only possible for RX1250.

Automatic connection

Establishing a connection is initiated automatically upon switching on RX1250.

OR

double clicking the icon  on Windows CE desktop to display the Leica software.

Requirements

The SmartAntenna interface is configured such that SmartAntenna is being used via Bluetooth.

AND

An **<ID Address:>** is available.

AND

A SmartAntenna is found that matches **<ID Address:>** configured. This can be the last used **<ID address:>**.

If one of these requirements is not fulfilled, a search for a SmartAntenna is performed.

Access

Select Main Menu: Config...\Interfaces.... Highlight **SmartAntenna**. **EDIT (F3)**.

CONFIGURE**SmartAntenna Interface**

```

11:38
CONFIGURE
SmartAntenna Interface
Use Device : Yes
Port      : Bluetooth 1
Device    : ATX1230
ID Address : 80371d9b13
  
```

CONT (F1)

To accept changes and return to the screen from where this screen was accessed.

To establish a connection to the SmartAntenna.

SRCH (F4)

Available for **<Use Device: Yes>**. To search for all available SmartAntenna's. If more than one SmartAntenna is found a list of available SmartAntenna's is provided.

DEVCE (F5)

Available for **<Use Device: Yes>**. To create, select, edit or delete a device. Refer to "23.2 Accessing CONFIGURE Devices / CONFIGURE GPRS Internet Devices".

```

CONT SRCH DEVCE Q1 a
  
```

Description of fields

Field	Option	Description
<Use Device:>	Yes or No	Activates the SmartAntenna interface.
<Port:>	Bluetooth x	Port to which the SmartAntenna will be connected. The Bluetooth port which will be used for the interface functionality. Enables cablefree communication between the SmartAntenna and the RX1250.
	Port 1	LEMO port on RX1250. To be selected when RX1250 and SmartAntenna are connected via USB cable.

Field	Option	Description
<Device:>	Output <Bluetooth x>	The device that is currently configured to <Port:>. The Bluetooth device inside the RX1250 that is currently configured to <Port:>.
<ID Address:>	Output	The ID address of the SmartAntenna to be used.

Next step

CONT (F1) returns to the screen from where **CONFIGURE SmartAntenna Interface** was accessed. A connection to the SmartAntenna is established.

22.11

Internet

Description

The Internet interface

- allows accessing the Internet using a GPS1200 receiver plus normally a GPRS device.
- can be used together with the Real-Time interface to receive real-time data from a NTRIP Caster via Internet communication.

Refer to "34.1 Overview" for information about NTRIP.

The settings on this screen define the port and parameters required for accessing the Internet.



This screen is not available for the GRX1200 Pro and GRX1200 GG Pro where Ethernet is used for the Internet connection. Refer to "24.8 Internet / Ethernet" for configuring the Ethernet interface.

Access

Select **Main Menu: Config...\Interfaces....** Highlight **Internet. EDIT (F3)**.

CONFIGURE Internet Interface

12:09
CONFIGURE
Internet Interface

Internet : Yes

Port : Port 1
Device : Siemens MC45

IP Address: Dynamic
Set IP Addr: 192.168.1.3
User ID : 123
(cont) : - - - -

Q1 a ↑
CONT DEVCE

CONT (F1)

To accept changes and return to the screen from where this screen was accessed.

DEVCE (F5)

To create, select, edit or delete a device. Refer to "23.2 Accessing CONFIGURE Devices / CONFIGURE GPRS Internet Devices".

Description of fields

Field	Option	Description
<Internet:>	Yes or No	Activates the Internet interface.
<Port:>	Bluetooth x Port x Port 1	Available for RX1250. The Bluetooth port which will be used for the interface functionality. The physical port P1, P2 or P3 on the instrument to which the device is attached. Available for RX1250. LEMO port on RX1250.
<IP Address:>		In order to get access to the Internet, an IP address is required. This IP address identifies the receiver in the Internet.

Field	Option	Description
	<p>Dynamic</p> <p>Static</p>	<p>The IP address to get access to the Internet is provided by the network provider dynamically. Each time a GPS1200 receiver wants to access the Internet via the device a new IP address is assigned to the receiver. When using GPRS to connect to the Internet then the network provider always dynamically assigns the IP address.</p> <p>The IP address to get access to the Internet is provided by the network provider permanently. Each time GPS1200 wants to access the Internet via the device the same IP address identifies the receiver. This is important if GPS1200 is used as a TCP/IP server. This option should only be selected if a static IP address is available for the receiver.</p>
<Set IP Adr:>	User input	Available for <IP Address: Static >. To set the IP address.
<User ID:>	User input	Some providers ask for a user ID to allow connecting to the Internet via GPRS. Contact your provider if a user ID needs to be used.
<(cont):>	User input	Allows the <User ID:> string to continue onto a new line.
<Password:>	User input	Some providers ask for a password to allow connecting to the Internet via GPRS. Contact your provider if a password is required.

Next step

CONT (F1) returns to the screen from where **CONFIGURE Internet Interface** was accessed.

22.12

PPS Output



The PPS output is an optional interface requiring a special port.

Description

PPS stands for **P**ulse **P**er **S**econd. It is a pulse that is output at a specified interval time. This can be used to activate another device. Additionally, a notification message can be output through ports P1, P2, P3 or RX when a PPS output occurs.

For example, in aerial photography, an aerial camera can be configured to take a photo each time it receives a pulse from the receiver.

The settings on this screen define the output port and parameters for the PPS option. This screen is available if the receiver is fitted with a PPS output port.

Access

Select **Main Menu: Config...\Interfaces....** Highlight **PPS Output. EDIT (F3).**



This option is not available for RX1250 with SmartAntenna.

CONFIGURE PPS Output

11:37

CONFIGURE

PPS Output

Output PPS : Yes

PPS Rate : 0.1s

Polarity : Positive Edge

Limit Error : Yes

Limit : 0 ns

Notify Msg : Binary

CONT NPORT

CONT (F1)

To accept changes and return to the screen from where this screen was accessed.

NPORT (F4)

Available unless **<Notify Msg: None>**. To configure the port and the device through which the notification message shall be transmitted. Refer to "22.16 Remote".

Description of fields

Field	Option	Description
<Output PPS:>	Yes or No	Activates the output of PPS.
<PPS Rate:>	From 0.05s to 20.0s	The rate at which pulses will be output.
<Polarity:>	Negative Edge or Positive Edge	Measure the time from the negative edge or the positive edge of the pulse.
<Limit Error:>		The output of PPS can be restricted by the accuracy of time. If the time accuracy is degraded below a defined value, for example, due to a lack of satellites, no PPS output is generated.

Field	Option	Description
	Yes or No	Activates the observation of the time accuracy limit within which pulses shall be generated.
<Limit:>	User input	Available for <Limit Error: Yes>. The time accuracy limit in nanoseconds.
<Notify Msg:>	None, Binary or ASCII	Activates the output of a notification message with each PPS output. Refer to "Appendix I PPS Output Notify Message Format" for information on the message format.

Next step

IF port and device for a notification message	THEN
are not to be configured	CONT (F1) closes the screen and returns to the screen from where CONFIGURE PPS Output was accessed.
are to be configured	NPORT (F4) . Refer to "22.16 Remote".



Description

The event input is an optional interface requiring a special port.

The event input interface allows pulses which are sent from devices connected to the receiver to be recorded. These records can later be superimposed on the processed kinematic data and the positions where the events took place can be interpolated in LGO. Events logged during real-time operations can also be exported to an ASCII file using an appropriate format file. Additionally, a notification message can be output through ports P1, P2, P3, RX or NET providing information about when the event occurred. A port configured as a remote port can be used to output the notification message.

For example, in aerial photography, an aerial camera can be connected via the event input port. When the shutter opens, the position at which the event occurred is recorded.

The settings on this screen define the input port and parameters for the event input option. This screen is available if the instrument is fitted with a event input port.

Technical specifications

Refer to the GPS1200 User Manual for technical specifications of the event input port and the required cable.

Access

Select **Main Menu: Config...Interfaces...** Highlight **Event Input. EDIT (F3)**.



This option is not available for RX1250 with SmartAntenna.

CONFIGURE Event Input

This screen consists of two identical pages, one for each event input port. The explanations given are valid for both pages.

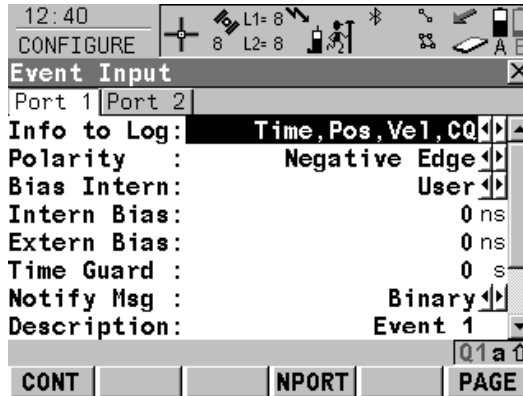

CONT (F1)

To accept changes and return to the screen from where this screen was accessed.

NPORT (F4)

To configure the port and the device through which the notification message shall be transmitted. Refer to "22.16 Remote".

Description of fields

Field	Option	Description
<Info to Log:>	Choicelist	Activates the detection and logging of events being sent to the event ports.
<Polarity:>	Negative Edge or Positive Edge	The polarity according to the device in use.
<Bias Intern:>	User or Factory	Accepts personal or default settings as calibration values for the particular receiver.
<Intern Bias:>	User input	Available for <Bias Intern: User>. Sets the particular calibration value in ns for the receiver.
<Extern Bias:>	User input	Sets a calibration value in ns according to the external event device and cable being used.

Field	Option	Description
<Time Guard:>	User input	If two or more events take place during the time defined in s, the first event will be recorded. Enter 0 to accept all events. The shortest recording time is 0.05 s.
<Notify Msg:>	None, Binary or ASCII	Activates the output of a notification message with each event input. Refer to "Appendix G Event Input Notify Message Format" for information on the message format.
<Description:>	User input	Records up to four lines of data with the event record. This is particularly useful if two event input ports are used at the same time in order to differentiate between the two event records.

Next step

IF port and device for a notification message	THEN
are not to be configured	CONT (F1) closes the screen and returns to the screen from where CONFIGURE Event Input was accessed.
are to be configured	NPORT (F4) . Refer to "22.16 Remote".

22.14

External Oscillator



Description

The external oscillator option is available on the GRX1200 Pro and GRX1200 GG Pro.

An external oscillator can be used to provide a better quality time signal to the GRX1200 Pro/GRX1200 GG Pro than the internal clock, for example, through the use of a rubidium or caesium oscillator. The same external oscillator can also be used with a number of receivers so that each GRX1200 Pro/GRX1200 GG Pro is guaranteed to be tracking satellites using the same time signal. An external oscillator is attached to the GRX1200 Pro/GRX1200 GG Pro via the port OSC.

The settings on this screen define the parameters for incoming external oscillator signals.

Technical specifications

Refer to the GPS1200 User Manual for technical specifications of the external oscillator port and the required cable.

Access

Select **Main Menu: Config...\Interfaces....** Highlight **Ext Osc EDIT (F3)**.

OR

Press a hot key configured to access the screen **CONFIGURE External Oscillator**. Refer to "6.1 Hot Keys" for information on hot keys.

OR

Press **USER**. Refer to "6.2 USER Key" for information on the **USER** key.

CONFIGURE External Oscillator

11:40

CONFIGURE

External Oscillator

Use Device : User

Frequency : 5 MHz

User Process Noise Elements

h0 : 1.000

Exponential e: -21

h1 : 1.000

Exponential e: -20

h2 : 1.000

Exponential e: -20

Q1 a ↑

CONT

CONT (F1)

To accept changes and return to the screen from where this screen was accessed.

Description of fields

Field	Option	Description
<Use Device:>	No	The type of external oscillator to use. An external oscillator is not been used. All other fields become unavailable.
	TCXO	To use a temperature compensated crystal oscillator.
	OCXO	To use an oven controlled crystal oscillator.
	Rubidium	To use a rubidium based external oscillator.
	Caesium	To use a caesium based external oscillator.

Field	Option	Description
	User	Allows noise elements to be defined for a customised external oscillator. The noise elements are used to describe the frequency noise characteristics of the oscillator. The noise elements are a value with a number part and an exponential part, for example, $1.0167e^{-23}$.
<Frequency:>	5 MHz or 10 MHz	The frequency of the external oscillator.
<h0:>	User input	Available for <Use Device: User> . The number part of the process noise element h0. Range: From $1.0e^{-31}$ to $1.0e^{-18}$.
<Exponential e:>	User input	Available for <Use Device: User> . The exponential part of the process noise elements h0, h1 and h2.
<h1:>	User input	Available for <Use Device: User> . The number part of the process noise element h1. Range: From $1.0e^{-31}$ to $1.0e^{-18}$.
<h2:>	User input	Available for <Use Device: User> . The number part of the process noise element h2. Range: From $1.0e^{-31}$ to $1.0e^{-18}$.

Next step

CONT (F1) returns to the screen from where **CONFIGURE Remote Interfaces** was accessed.

22.15

ASCII Remote

Description

The ASCII remote interface is used to

- send a command from a PC through the GX1200 to a third party device, e.g. a barometer.
- receive a message from a third party device through the GX1200 at a PC.

For requesting ASCII Data a **Outside World Interface** or **Leica Binary 2** command is used. Documentation for OWI and LB2 is available on request from the Leica Geosystems representative.

The settings on this screen define the port and parameters for connecting a PC.



- The PC must be connected to a port assigned to the remote interface.
 - The third party device must be connected to the port assigned to the ASCII remote interface.
-

Access

Select **Main Menu: Config...\Interfaces....** Highlight **ASCII Remote. EDIT (F3)**.

CONFIGURE
ASCII Remote

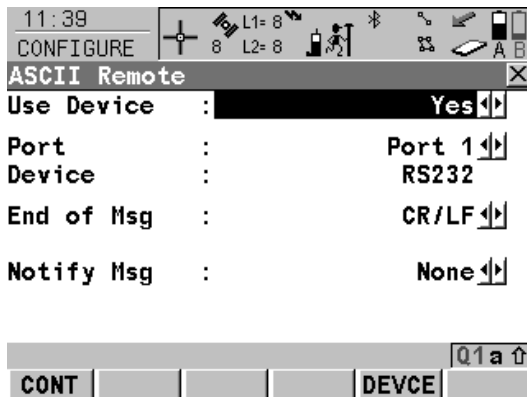

CONT (F1)

To accept changes and return to the screen from where this screen was accessed.

DEVE (F5)

To create, select, edit or delete a device. Refer to "23.2 Accessing CONFIGURE Devices / CONFIGURE GPRS Internet Devices".

Description of fields

Field	Option	Description
<Use Device:>	Yes or No	Activates the interface.
<Port:>	Bluetooth x	Available for RX1250. The Bluetooth port which will be used for the interface functionality.
	NETx	Available for an activated Internet interface. If these ports are not assigned to a specific interface, then these ports are additional remote ports.
	Port x	The physical port P1, P2 or P3 on the instrument to which the device is attached.
	Port 1	Available for RX1250. LEMO port on RX1250.

Field	Option	Description
<Device:>	Output	The device currently assigned to the selected port within the active configuration set.
<End of Msg:>	None, CR, LF or CR/LF	The character to be used to identify the end of the incoming ASCII message.
<Data Rate:>	From 0.1s to 60.0s	Available for <End of Msg: None>. The receiver takes the ASCII data that it received from the third party device over the defined time span and passes them on to the PC.
<Notify Msg:>	None, ASCII or Binary	Activates the output of a notification message. The format is OWI or LB2 v2. Documentation for OWI and LB2 is available on request from the Leica Geosystems representative.

Next step

CONT (F1) returns to the screen from where **CONFIGURE ASCII Remote** was accessed.

22.16

Remote

Description

The remote interface allows:

- the receiver to be controlled using a device other than the RX1200, e.g. a PC. **Outside World Interface** or Leica Binary 2 commands can be used to control the receiver through the remote port. Documentation for OWI and LB2 is available on request from the Leica Geosystems representative.
- a message log to be requested from a remote client via an OWI message. A message log contains a history of warning messages and message lines. It is not possible to view a message log in the RX1200.
- the downloading of data directly from the receiver's memory device to LGO through a serial port on the PC. The RX1200 does not need to be removed from the receiver.

The settings on this screen define the port and the device to be used for the remote control.



A port configured as a remote port can be used to output event input, meteo or tilt notification messages.



Except for the GRX1200 Series the OWI commands listed below are protected by a licence key. Refer to "30 Tools...\Licence Keys" for information on how to type in the licence key. The corresponding LB2 commands are also protected. If these OWI commands have been activated by a licence key is indicated in **STATUS System Information, Instrument** page.

- | | | | | |
|-------|-------|-----------|-------|-------|
| • AHT | • DPM | • LLQ | • RMC | • POQ |
| • ANT | • GGA | • GGK | • RTK | • SCC |
| • CNF | • GLL | • GGK(PT) | • TPV | • USR |
| • DCF | • GNS | • GGQ | • POB | |
| • DCT | • LLK | • POS | • POE | |

Access

CONFIGURE Remote Interfaces

Select **Main Menu: Config...Interfaces...**. Highlight **Remote**. **EDIT (F3)**.

Port	Interface	Device
1	Remote	-
2	Remote	-
3	Remote	-
RX	Remote	-
NET1	Remote	Ethernet
NET2	Remote	Ethernet
NET3	Remote	Ethernet

Q1 a ↑

CONT CTRL

CONT (F1)

To accept changes and return to the screen from where this screen was accessed.

CTRL (F4)

To configure additional parameters. Refer to "24 Config...Interfaces... - Controlling Devices".

DEVCE (F5)

Available unless <Port: NETx>. To create, select, edit or delete a device. Refer to "23.2 Accessing CONFIGURE Devices / CONFIGURE GPRS Internet Devices".

USE (F6)

Available unless the interface of the highlighted port is **NMEA Out** or **Remote**. To use the highlighted interface by **Remote**.

Description of columns

Column	Description
Port	The physical port on the instrument which will be used for the interface functionality.
Interface	The interface configured for the ports. Any port which is not configured is automatically assigned the remote interface.

Column	Description
Device	The hardware connected to the chosen port.

Next step

CONT (F1) returns to the screen from where **CONFIGURE Remote Interfaces** was accessed.

23 Configuration of Devices

23.1 Devices

23.1.1 Overview

Description

A device is the hardware which is connected to a chosen port of GPS1200. Devices are used to transmit and receive real-time data and to communicate with the receiver, for example to download raw observations from a remote location.

Before using any device it is necessary to configure the interface with which it will be used. Refer to "22.2 Accessing Configuration Interfaces" for information on how to configure the interfaces.

Some devices may be used with different interfaces for different applications. For example, a radio can be used to receive real-time reference data but a second radio could also be used to simultaneously output NMEA messages.

Next step

IF more information is required on	THEN
digital cellular phones	Refer to "23.1.2 Digital Cellular Phones".
modems	Refer to "23.1.3 Modems".
radios	Refer to "23.1.4 Radios".
RS232	Refer to "23.1.5 RS232".
SAPOS	Refer to "23.1.6 SMARTgate".
hidden point measurement devices	Refer to "23.1.7 Hidden Point Measurement Devices".
GPRS / Internet devices	Refer to "23.1.8 GPRS / Internet Devices".

23.1.2

Digital Cellular Phones

Description

Digital cellular phones comprise of the technologies CDMA and GSM with its subgroup GPRS.

Typical uses

- To transmit real-time data.
- To download raw observations from a remote location.
- To receive real-time data.
- To steer a receiver.

Example use

Step	Description
1.	Reference and rover must both be equipped with a digital cellular phone.
2.	Ensure that the digital cellular phone at the reference is on.
3.	The rover digital cellular phone contacts the selected reference of which the phone number was pre-defined. Refer to "23.3 Creating a New Device".
4.	One rover can dial in to the reference digital cellular phone at a time.
5.	As soon as the reference digital cellular phone is contacted, real-time data is sent to the rover digital cellular phone that has called.
	Several digital cellular phone numbers can be pre-defined on the rover. Dialing a different number dials that particular reference station.

Requirements for using digital cellular phones

Always required:

- AT command language must be supported by the digital cellular phone. Refer to "23.3 Creating a New Device".
- Working area must be covered by a digital cellular phone network.
- The network operator must support data transmission.

- Sometimes required:
- SIM card. This is the same SIM card as normally used in mobile phones. The SIM card must be enabled to transmit data. Contact the service provider to enable the SIM card.
 - **Personal Identification Number**
 - Registration

Supported digital cellular phones

Default digital cellular phones fitting into a clip-on-housing

- CDMA MultiTech MTMMC-C (US)
- CDMA MultiTech MTMMC-C (CAN)
- Siemens MC75
-

Default digital cellular phones not fitting into a clip-on-housing

These digital cellular phones must be connected with a cable. Refer to "Appendix E Cables" for information on cables.

- Siemens M20
- Siemens S25/S35i
- Siemens TC35
- Wavecom M1200 Series

These digital cellular phones can be connected via bluetooth or cable using the implemented standard device provided for the below mentioned cellular phone manufacturers.

- Motorola RAZR v3
- Motorola E1000
- Nokia 6021
- Nokia 6230(i)
- Nokia 6310(i)
- Nokia 6630
- Nokia 6822a
- Nokia N80
- Siemens S55
- Siemens S65
- Siemens S65v
- SonyEricsson K700i
- SonyEricsson K750i
- SonyEricsson K800i
- SonyEricsson P900
- SonyEricsson S700i

- Siemens M75

- SonyEricssonT610

User defined digital cellular phones

Other digital cellular phones than those listed above can be used. Their settings must be defined by creating a new digital cellular phone configuration. Refer to "23.3 Creating a New Device". These digital cellular phones must be connected with a cable or bluetooth. Refer to "Appendix E Cables" for information on cables. Please contact the local selling unit or dealer for further information.

Advantages

- Unlimited range of the data link between reference and rover.
 - Free of jamming from other users.
 - Cheaper in price in the initial costs of buying.
-

Disadvantages



Fees are charged for the time that the digital cellular phone network is being used.

Reference and rover can both be equipped with a digital cellular phone and a radio. On the reference they operate simultaneously. On the rover, use the radio when within radio range of the reference and the digital cellular phone when radio reception is not possible.

23.1.3

Modems

Typical uses

- To transmit NMEA messages.
- To download raw observations from a remote location.
- To transmit real-time data
-

Example of use

Step	Description
1.	The reference is equipped with a modem.
2.	The rover is equipped with a digital cellular phone.
3.	Ensure that the modem is switched on.
4.	The rover digital cellular phone contacts the selected reference of which the phone number was pre-defined. Refer to "23.3 Creating a New Device".
5.	One rover can dial in to the reference modem at a time.
6.	As soon as the reference modem is contacted, it sends its data to the rover digital cellular phone that has called.
	Several modem numbers can be pre-defined on the rover. Dialing a different number changes the reference station.

Requirements for using modem

AT command language must be supported by the modem. Refer to "23.3 Creating a New Device".

Supported modems

Default modems

- AirLink CDMA
- U.S. Robotics 56K

Modems must be connected with a cable. Refer to "Appendix E Cables" for information on cables.

User defined modems

Other modems than those listed above can be used. Their settings must be defined by creating a new modem configuration. Refer to "23.3 Creating a New Device".

23.1.4**Radios****Typical uses**

- To transmit real-time data.
- To receive real-time data.
- To download raw observations from a remote location.
- To steer a receiver.

Example of use

Step	Description
1.	Reference and rover must both be equipped with radios using the same frequency range and the same data format.
2.	The reference radio continuously sends out real-time data until the receiver is turned off, the configuration is changed or the radio is detached.
3.	The rover radio continuously receives real-time data until the receiver is turned off, the configuration is changed or the radio is detached.
4.	Several rovers can receive data from the same reference at the same time.
	Several reference radios can transmit real-time data simultaneously using different radio channels. Changing to a different radio channel on the rover changes the reference from which real-time data is received.

Supported radios**Default radios fitting into a clip-on-housing**

- Intuicom 1200 Data Link
- Pacific Crest PDL, receive
- Satelline 3AS, transceive

Default radios not fitting into a clip-on-housing

These radios must be connected with a cable. Refer to "Appendix E Cables" for information on cables.

- AT-RXM500, Akasaka Tech
- Pacific Crest RFM96W
- Satelline 2ASx
- Satelline 2ASxE

User defined radios

Other radios than those listed above can be used. Their settings must be defined by creating a new radio configuration. Refer to "23.3 Creating a New Device". These radios must be connected with a cable. Refer to "Appendix E Cables" for information on cables.



Reference and rover can both be equipped with a radio and a digital cellular phone. On the reference they operate simultaneously. On the rover, use the radio when within radio range of the reference and the digital cellular phone when radio reception is not possible.

23.1.5

RS232

Typical uses

To exchange information with a device via an RS232 interface, for example sending NMEA messages to a computer. Port P1, P2, P3 and the RX port of the receiver are standard RS232 interfaces. The device is always connected with a cable. Refer to "Appendix E Cables" for information on cables.

Example of use

Step	Description
1.	A device with an RS232 interface must be connected to the receiver.
2.	Information can be continuously or sporadically exchanged between the receiver and the device. For example NMEA messages are continuously send out from the receiver. Commands to steer the receiver are send sporadically from a device.
3.	A connection is maintained until the receiver is turned off, the configuration is changed or the device is detached.

Standard RS232

Standard RS232 is supported by default. The settings are:

Baud rate:	115200	Stop bits:	1
Parity:	None	Flow control:	None
Data bits:	8		

23.1.6

SMARTgate

Description

SMARTgate is a device with an integrated digital cellular phone, a radio and the functionality of a SAPOS-Box, available in a Leica radio housing. The **SA**tellite **PO**sitioning service is a reference station service available in Germany. Refer to www.navsys.de for more information about the SMARTgate device.

Example of use

Step	Description
1.	The rover is equipped with a SMARTgate device.
 2.	SMARTgate cannot be used with RX1250.
2.	The SMARTgate radio continuously receives real-time data from the SAPOS service until the radio link is broken.
3.	The SMARTgate digital cellular phone then automatically contacts the SAPOS service and real-time data link is resumed via the digital cellular phone network.
4.	Once radio contact is possible again, the digital cellular phone connection is ended and the radio real-time data link is resumed.

User profiles

There is one default user profile initially available with the SMARTgate box. This user profile can be edited using the manufacturer's software provided with the SMARTgate box. New user profiles can also be created using the software. User profiles contain information about the kind of communication, the service employed, the account used, a list of reference stations and an acceptable minimum distance. Refer to the manufacturer's specifications for more information about user profiles.

23.1.7

Hidden Point Measurement Devices

Typical uses

To measure

- distances, using laser technology
- angles
- azimuths

to points which are not directly accessible by means of GPS, for example house corners or trees. The measurements taken with hidden point measurement devices are directly transferred if the device is connected to the receiver. If the device is not connected, measurement can be typed in manually to calculate the coordinates of a hidden point.

Example of use

Step	Description
1.	A receiver must be in <R-Time Mode: None> or <R-Time Mode: Rover> .
2.	A hidden point measurement device is connected to the receiver via cable.
3.	Hidden point measurements are configured and activated.
4.	Distances, angles and azimuths are measured to the hidden point with the hidden point measurement device.
5.	The measurements are directly transferred to the receiver and displayed in the appropriate fields.
	Hidden point measurement devices can be connected in addition to any of the other devices. They can be active at the same time. Changing of ports is not required.

Supported hidden point measurement devices

Default hidden point measurement devices

All devices support reflectorless distance measurements using laser technology.

- Criterion 400
- Criterion Compatible
- Laser Ace 300
- Leica Disto memo
- Leica Disto pro
- Leica DistoTM pro⁴
- Leica DistoTM pro⁴ a
- Leica DistoTM classic⁵
- Leica DistoTM A6
- Leica Laser Locator
- Leica Laser Locator Plus
- Leica Vector

User defined hidden point measurement devices

Other hidden point measurement devices than those listed above can be used. Their settings must be defined by creating a new hidden point measurement device. Refer to "23.3 Creating a New Device".



In order to connect a device to the receiver use the cable delivered with the device. Refer to "Appendix E Cables" for information on cables.

23.1.8**GPRS / Internet Devices****Description**

GPRS is a telecommunication standard for transmitting data packages using the Internet Protocol.

When using GPRS technology charges are made based on the amount of transferred data and not as for normal digital cellular phones where charges are made for the connection time.

Typical uses

To access the Internet with a GPS1200 receiver in order to receive real-time data from the Internet.

Example use

Step	Description
	This is an example use for receiving data from the Internet.
1.	Rover must be equipped with a GPRS / Internet device.
2.	The GPRS / Internet device accesses the Internet where the rover connects for example to NTRIP.
3.	The rover receives real-time corrections from this other computer in the Internet.

Requirements for using GPRS / Internet devices

- AT command language must be supported by the digital cellular phone. Refer to "23.3 Creating a New Device".
- **Access Point Name** of a server from the network provider. The APN can be thought of as the home page of a provider supporting GPRS data transfer.
- SIM card. This is the same SIM card as normally used in mobile phones. The SIM card must be enabled to transmit data. Contact the service provider to enable the SIM card.
- **Personal Identification Number**

- Registration
-

Supported GPRS / Internet devices

Default GPRS / Internet devices fitting into a clip-on-housing

- Siemens MC75

User defined GPRS / Internet devices

Other GPRS capable devices than those listed above can be used as long as they use AT commands. Their settings must be defined by creating a new GPRS / Internet device configuration. Refer to "23.3 Creating a New Device". These GPRS / Internet devices must be connected with a cable. Refer to "Appendix E Cables" for information on cables. Please contact the local selling unit or dealer for further information.

Advantages

- Unlimited range of the data link between reference and rover.
 - Free of jamming from other users.
 - Fees are charged for the amount of data being transferred.
-

23.2

Accessing CONFIGURE Devices / CONFIGURE GPRS Internet Devices

Description

Allows devices to be created, edited, selected and deleted. Refer to "24 Config...\Interfaces... - Controlling Devices" for more information about configuring devices.

Access step-by-step

Step	Description
1.	Main Menu: Config...\Interfaces...
2.	Highlight the appropriate interface based on the type of device that needs to be configured. For example, highlight Real-Time when a radio is to be configured.
3.	EDIT (F3) to access CONFIGURE XX .
4.	DEVCE (F5) to access CONFIGURE Devices / CONFIGURE GPRS Internet Devices . Refer to paragraph "CONFIGURE Devices; CONFIGURE GPRS Internet Devices".

CONFIGURE Devices; CONFIGURE GPRS Internet Devices

This screen may consist of several pages and provides different devices for selection depending on which interface the screen was accessed from. The functionality described below is always the same.

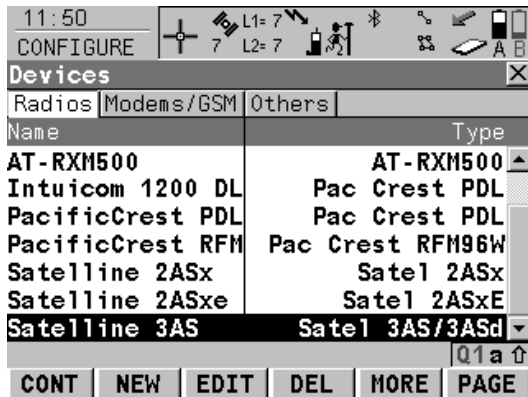

CONT (F1)

To select the highlighted device and return to the screen from where this screen was accessed.

NEW (F2)

To create a new device. Refer to "23.3 Creating a New Device".

EDIT (F3)

To edit the highlighted device. Refer to "23.4 Editing a Device".

DEL (F4)

To delete the highlighted device.

MORE (F5)

To display information about the type of device and the creator of the device.

PAGE (F6)

To change to another page on this screen.

SHIFT ALL (F4) or SHIFT FILT (F4)

Available for Internet and bluetooth devices. To list all devices or to hide devices which are not Internet or bluetooth capable.

SHIFT DEFLT (F5)

To recall previously deleted default devices and to reset default devices to the default settings.

Description of columns

Column	Description
Name	Names of available devices.
Type	Type of device defined when creating the device.
Creator	<p>The creator of the device. The creator can either be Default if the device is a default, or User if the device has been created.</p> <p> If a Default device is edited by using EDIT (F3) then its creator is still displayed as Default.</p>

Next step

IF the desired device is	THEN
present in the list	<p>highlight the desired device.</p> <p>CONT (F1) to close the screen and to return to the screen from where CONFIGURE Devices / CONFIGURE GPRS Internet Devices was accessed.</p>
is not present in the list	NEW (F2) . Refer to "23.3 Creating a New Device".
is present in the list but needs to be edited	<p>highlight the desired device.</p> <p>EDIT (F3). Refer to "23.4 Editing a Device".</p>

23.3

Creating a New Device

Description

Allows a new device to be configured.

Access step-by-step

Step	Description
1.	Refer to "23.2 Accessing CONFIGURE Devices / CONFIGURE GPRS Internet Devices" to access CONFIGURE Devices / CONFIGURE GPRS Internet Devices .
2.	Highlight a device of the same type as the device to be created, from the list.
3.	NEW (F2) to access CONFIGURE New Device .

CONFIGURE New Device

11:53
CONFIGURE
New Device

Name : **New Radio**
Type : **Satel 3AS/3ASd**

Baud Rate : **9600**
Parity : **None**
Data Bits : **8**
Stop Bit : **1**
Flow Control : **RTS/CTS**

Q1 a ↑
STORE

STORE (F1)

To store the new device and to return to the screen from where this screen was accessed.

ATCMD (F4)

Available for digital cellular phones and modems. To configure communication commands. Refer to paragraph "CONFIGURE GSM/Modem AT Command Lines".

Description of fields

Field	Option	Description
<Name:>	User input	Name of new device.
<Type:>	Output	Same device type as was highlighted when NEW (F2) was used.
<GPRS/ Internet:>	Yes or No	Available for digital cellular phones and modems. Defines the device as an Internet capable device and adds it to the list in CONFIGURE GPRS Internet Devices .
<Baud Rate:>	From 2400 to 115200	Frequency of data transfer from receiver to device in bits per second.
<Parity:>	None, Even or Odd	Error checksum at the end of a block of digital data.
<Terminator:>	CR/LF CR	Available if required by the interface. The terminator is a carriage return followed by a line feed. Not available for RS232 device. The terminator is a carriage return.
<Data Bits:>	6, 7 or 8	Number of bits in a block of digital data.
<Stop Bits:>	1 or 2	Number of bits at the end of a block of digital data.

Field	Option	Description
<Flow Control:>	None or RTS/CTS	Activates hardware handshake. When the receiver/device is ready for data, it asserts the Ready To Send line indicating it is ready to receive data. This is read by the sender at the Clear To Send input, indicating it is clear to send the data.

Next step

IF the device is a	THEN
radio or device other than digital cellular phone or modem	STORE (F1) to close the screen and to return to the screen from where CONFIGURE New Device was accessed.
digital cellular phone or modem	ATCMD (F4) . Refer to paragraph "CONFIGURE GSM/Modem AT Command Lines".

CONFIGURE GSM/Modem AT Command Lines

For <GPRS/Internet: Yes> in **CONFIGURE New Device**, this screen consists of two pages:

- GSM/CSD** page: The AT commands configure the devices for normal digital cellular phone/modem mode.
- GPRS/Internet** page: The AT commands configure the devices for GPRS/Internet mode. Please refer to the manual of the GPRS / Internet device for information about which AT commands need to be entered or contact the supplier.

The following table lists the fields of both pages.

Description of fields

Field	Option	Description
<Init 1:>	User input	Initialisation sequence to initialise digital cellular phone/modem.
<(cont):>	User input	Allows the <Init X:> or the <Connect:> string to continue onto a new line.
<Init 2:>	User input	Initialisation sequence to initialise digital cellular phone/modem.
<Dial:>	User input	Dialing string used to dial the phone number of the real-time reference.
<Hangup:>	User input	Hangup sequence used to end the network connection.
<Escape:>	User input	Escape sequence used to switch to the command mode before using the hangup sequence.
<Connect:>	User input	Dialing string used to dial into the Internet.

When the device is used, between <Init 1:> and <Init 2:>, a check for the PIN is performed. Refer to "Appendix J AT Commands" for more information about AT commands.

Next step

STORE (F1) returns to **CONFIGURE Devices / CONFIGURE GPRS Internet Devices**.

23.4

Editing a Device

Access step-by-step

Step	Description
1.	Refer to "23.2 Accessing CONFIGURE Devices / CONFIGURE GPRS Internet Devices" to access CONFIGURE Devices / CONFIGURE GPRS Internet Device .
2.	Highlight the device to be edited from the list.
3.	EDIT (F3) to access CONFIGURE Edit Device .

CONFIGURE Edit Device

The availability of options may change depending on the selected device. Most fields are identical with the creation of a new device. Refer to "23.3 Creating a New Device" for information on the fields.

Next step

STORE (F1) to close the screen and to return to the screen from where **CONFIGURE Edit Device** was accessed.

24**Config...\Interfaces... - Controlling Devices**

24.1 Digital Cellular Phones**24.1.1 Overview**

Description

For digital cellular phones, information such as

- the reference stations that can be contacted
- the phone numbers of the reference stations and
- the type of protocol to be used

can be defined.

Changing the reference station to be dialled is of interest in two cases.

Case 1: Two real-time reference stations, each equipped with a digital cellular phone, are set up at two locations belonging to different network providers. When leaving the area of one reference, the station can be changed and the other reference can be called.

Case 2: Set up as in case 1. Two separate fixes from each reference for each point can be obtained, providing redundancy for future least squares adjustment operations.

Technologies

CDMA **C**ode **D**ivision **M**ultiple **A**ccess is a high speed data transmission for very effective and flexible use of available resources such as band width. Users of a cellular phone network occupy the same frequency band. The signal is especially coded for each user.

GSM

Global **S**ystem for **M**obile Communications is a more efficient version of CDMA technology that uses smaller time slots but faster data transfer rates. It is the world's most commonly used digital network.

Next step

IF using a digital cellular phone of technology	THEN
GSM	Refer to "24.1.2 Configuring a GSM Connection".
CDMA	Refer to "24.1.3 Configuring a CDMA Connection".



24.1.2

Configuring a GSM Connection

Configure GSM connection step-by-step

The following table explains the most common settings. Refer to the stated chapter for more information on screens.

Step	Description	Refer to chapter
1.	Refer to "22.2 Accessing Configuration Interfaces" to access CONFIGURE Interfaces .	
2.	In CONFIGURE Interfaces highlight an interface which has a digital cellular phone of GSM technology attached.	23
3.	CTRL (F4) to access CONFIGURE GSM Connection .	
4.	<p>CONFIGURE GSM Connection</p> <p><GSM Type:> The type of digital cellular phone highlighted when CONFIGURE GSM Connection was accessed.</p> <p><Bluetooth:> GPS1200 receivers detect automatically if the attached devices is bluetooth capable. Some GSM's ask for the identification number of the Bluetooth. The identification number of Leica's Bluetooth is 0000. The field is unavailable for RX1250 with SmartAntenna.</p> <p><ID Address:> Available for <Bluetooth: Yes>. The ID address of the Bluetooth device to be used. Refer to the device's user manual for information about the ID address.</p>	

Step	Description	Refer to chapter
	NEAR (F2) finds the nearest reference station with a digital cellular phone of GSM technology. Available when reference stations to dial are already created in CONFIGURE Stations to Dial . Coordinates of these stations must be known.	24.10
5.	CODES (F3) accesses CONFIGURE GSM Codes to enter the Personal Identification Number of the SIM card. If the PIN is locked for any reason, for example the wrong PIN was entered, input the Personal Unblock ing code for access to the PIN.	
	SRCH (F4) available for <Bluetooth: Yes> , to search for all available Bluetooth devices. If more than one Bluetooth device is found a list of available devices is provided.	
	SHIFT CMND (F4) allows AT commands to be sent to the digital cellular phone.	Appendix J
6.	CONT (F1) returns to CONFIGURE Interfaces .	



24.1.3

Configure CDMA connection step-by-step

Configuring a CDMA Connection

The following table explains the most common settings. Refer to the stated chapter for more information on screens.

Step	Description	Refer to chapter
1.	Refer to "22.2 Accessing Configuration Interfaces" to access CONFIGURE Interfaces .	
2.	In CONFIGURE Interfaces highlight an interface which has a digital cellular phone of CDMA technology attached.	23
3.	CTRL (F4) to access CONFIGURE CDMA Connection .	
4.	CONFIGURE CDMA Connection <CDMA Type:> The type of digital cellular phone highlighted when CONFIGURE CDMA Connection was accessed. <Station:> The digital cellular phone reference station to be dialled. Accesses CONFIGURE Stations to Dial where new reference stations can be created and existing reference stations can be selected or edited. <Number:> The number of the digital cellular phone at the selected <Station:> as configured in CONFIGURE Stations to Dial . <Auto CONEC:> Allows for automatic connection between the rover and the reference when a point is occupied during a survey. Select the digital cellular phone reference station to be dialled.	24.10 44.3.2, 44.3.3

Step	Description	Refer to chapter
	NEAR (F2) finds the nearest reference station with a digital cellular phone of CDMA technology. Available when reference stations to dial are already created in CONFIGURE Stations to Dial . Coordinates of these stations must be known.	24.10
5.	CONT (F1) returns to CONFIGURE CDMA Connection .	
	SHIFT CMND (F4) allows AT commands to be sent to the digital cellular phone.	Appendix J
	<p>SHIFT INFO (F2) provides information about the CDMA device being used, such as the manufacturer, the model and the electronic serial number.</p> <p>For registration purposes, send the electronic serial number to the network provider in order to receive the service programming code and the mobile directory number. These numbers must be typed in in CONFIGURE CDMA Registration. All information can be printed to a file CDMA Info.log in the \DATA directory on the CompactFlash card.</p>	
6.	SHIFT REG (F3) to access CONFIGURE CDMA Registration .	
7.	<p>CONFIGURE CDMA Registration</p> <p>The settings allow the CDMA digital cellular phone to be registered over the air.</p> <p><Prog Code:> Type in the service program code provided by the network provider.</p>	

Step	Description	Refer to chapter
	< My Phone No: > Type in the mobile directory number provided by the network provider.	
	CLEAR (F5) deletes the input of the highlighted field.	
8.	CONT (F1) returns to CONFIGURE Interfaces .	

24.2

Modems

Description

For modems, information such as

- the reference stations that can be contacted and
 - the phone numbers of the reference stations
- can be controlled.

Changing the reference station to be dialed is of interest in two cases.

Case 1: Two real-time reference stations, each equipped with a digital cellular phone, are set up at two locations belonging to different network providers. When leaving the area of one reference, the station can be changed and the other reference can be called.

Case 2: Set up as in case 1. Two separate fixes from each reference for each point can be obtained, providing redundancy for future least squares adjustment operations.

Configure modem connection step-by-step

The following table explains the most common settings. Refer to the stated chapter for more information on screens.

Step	Description	Refer to chapter
1.	Refer to "22.2 Accessing Configuration Interfaces" to access CONFIGURE Interfaces .	
2.	In CONFIGURE Interfaces highlight an interface which has a modem attached.	23
3.	CTRL (F4) to access CONFIGURE Modem Connection .	

Step	Description	Refer to chapter
4.	<p>CONFIGURE Modem Connection</p> <p><Modem Type:> The type of modem highlighted when CONFIGURE Modem Connection was accessed.</p> <p><Station:> The modem reference station to be dialled. Accesses CONFIGURE Stations to Dial where new reference stations can be created and existing reference stations can be selected or edited.</p> <p><Number:> The number of the modem at the selected <Station:> as configured in CONFIGURE Stations to Dial.</p> <p><Auto CONEC:> Allows for automatic connection between the rover and the reference when a point is occupied during a survey.</p> <p>Select the modem reference station to be dialled.</p>	24.10 44.3.2, 44.3.3
	<p>NEAR (F2) finds the nearest reference station with a modem. Available when reference stations to dial are already created in CONFIGURE Stations to Dial. Coordinates of these stations must be known.</p>	24.10
5.	<p>CONT (F1) returns to CONFIGURE Interfaces.</p>	

24.3

Radios

Description

For radios the channels on which the radio broadcasts can be changed. Changing channels changes the frequency at which the radio operates. The following radios support channel changing:

- AT-RXM500
- Pacific Crest PDL
- Pacific Crest RFM96W
- Satelline 2Asx
- Satelline 2AsxE
- Satelline 3AS

Changing radio channels is of interest in three cases.

Case 1: Two real-time reference stations are set up at two locations, each broadcasting on a different channel.

If the signal from one reference station is jammed, the channel can be changed and the other reference can be used.

Case 2: Set up as in case 1.

Two separate fixes for each point can be obtained, providing redundancy for future least squares adjustment operations.

Case 3: One real-time reference and one real-time rover are being used.

If the signal is blocked due to radio interference, the channel at the reference and the rover can be changed in order to work on a different frequency.

Requirements for channel changing

- Pacific Crest radios:
- Channel changing must be activated by a Pacific Crest dealer.
 - A special licence might be required.
- Satelline radios:
- The radio must be in programming mode. This can be set by a Satelline dealer.
-



Channel changing may contravene radio broadcasting regulations in certain countries. Before operating with radios, check the regulations in force in the working area.



The number of channels available and the frequency spacing between channels depends on the radio used.



If channel changing is to be used, when configuring the reference real-time interface, set **<Ref Stn ID:>** in **CONFIGURE Additional Reference Options, General** page to a different ID for each reference site. By doing so, the rover can recognise if the incoming real-time data after channel changing is being received from a different reference station or if the original reference station is using a new frequency. In the first case, the ambiguities are recomputed.

Configure radio channel step-by-step

The following table explains the most common settings. Refer to the stated chapter for more information on screens.

Step	Description	Refer to chapter
1.	Refer to "22.2 Accessing Configuration Interfaces" to access CONFIGURE Interfaces .	
2.	In CONFIGURE Interfaces highlight an interface which has a radio attached.	23
3.	CTRL (F4) to access CONFIGURE Radio Channel .	
4.	CONFIGURE Radio Channel <Radio Type:> The type of radio highlighted when CONFIGURE Radio Channel was accessed.	

Step	Description	Refer to chapter
	<p><Channel:> The radio channel. The channel used must be within minimum and maximum allowed input values. The minimum and maximum allowed input values for a radio depend on the number of channels supported by the radio and the spacing between the channels.</p> <p><Actual Freq:> Available for <Radio Type: Satellite 3AS>. Displays the actual frequency of the radio.</p> <p>Type in the radio channel.</p>	
	<p>SCAN (F5) Provides information such as the station ID, latency and the data format of incoming signals from reference stations broadcasting on the same radio channel. This information can be used to select appropriate reference stations to dial.</p>	24.9
5.	CONT (F1) returns to CONFIGURE Interfaces screen.	

24.4

RS232



Description

RS232 is a standard serial communication method that is able to transfer data without the need for predefined time slots. RS232 can be used, with a Bluetooth housing, to provide a wireless connection to another Bluetooth enabled device, for example, a computer.

Configure RS232 connection step-by-step

The following table explains the most common settings. Refer to the stated chapter for more information on screens.

Step	Description	Refer to chapter
1.	Refer to "22.2 Accessing Configuration Interfaces" to access CONFIGURE Interfaces .	
2.	In CONFIGURE Interfaces highlight an interface which has an RS232 device attached.	23
3.	CTRL (F4) to access CONFIGURE RS232 Connection .	
4.	CONFIGURE RS232 Connection <Type:> The type of device highlighted when CONFIGURE RS232 Connection was accessed. <Bluetooth:> GPS1200 receivers detect automatically if the attached devices is bluetooth capable. Some devices ask for the identification number of the Bluetooth. The identification number of Leica's Bluetooth is 0000. The field is unavailable for RX1250 with SmartAntenna.	

Step	Description	Refer to chapter
	<ID Address:> Available for <Bluetooth: Yes> . The ID address of the Bluetooth device to be used. Refer to the device's user manual for information about the ID address.	
	SRCH (F4) available for <Bluetooth: Yes> , to search for all available Bluetooth devices. If more than one Bluetooth device is found a list of available devices is provided.	
	SCAN (F5) provides information such as the station ID, latency and the data format of incoming signals from reference stations. This information can be used to select appropriate reference stations to dial.	24.9
5.	CONT (F1) returns to CONFIGURE Interfaces .	

Description

SMARTgate boxes contain GSM and radio devices with the integrated functionality of a SAPOS box. For SMARTgate boxes, one channel corresponds to one out of several particular frequencies configured on the radio. Changing channels changes the frequency at which the radio operates.

Changing channels on a SMARTgate box is of interest in three cases:

- Case 1: Two real-time reference stations are set up at two locations, each broadcasting on a different channel.
If the signal from one reference station is jammed, the channel can be changed and the other reference can be used.
- Case 2: Set up as in case 1.
Two separate fixes for each point can be obtained, providing redundancy for future least squares adjustment operations.
- Case 3: One real-time reference and one real-time rover are being used.
If the signal is blocked due to radio interference, the channel at the reference and the rover can be changed in order to work on a slightly different frequency.



This option is not available for RX1250 with SmartAntenna.

Configure SMARTgate connection step-by-step

The following table explains the most common settings. Refer to the stated chapter for more information on screens.

Step	Description	Refer to chapter
1.	Refer to "22.2 Accessing Configuration Interfaces" to access CONFIGURE Interfaces .	
2.	In CONFIGURE Interfaces highlight an interface which has a SMARTgate box attached.	23
3.	CTRL (F4) to access CONFIGURE SMARTgate Connection .	
4.	<p>CONFIGURE SMARTgate Connection</p> <p><Profile:> List of user profiles that can be used.</p> <p><Profile No.:> Number of the profile selected in <Profile:>.</p> <p><Ref Select:> The way in which the reference station is selected.</p> <p><Ref Select: Profile> selects a reference station according to a given profile. <Ref Select: Frequency> to input a frequency different to that specified by the user profile. <Ref Select: Phone No> to input a phone number different to that specified by the user profile. <Ref Select: Station No> to input a station number different to that specified by the user profile.</p> <p><XX:> Available for <Ref Select: Frequency>, <Ref Select: Phone No> and <Ref Select: Station No> to input the values different to those present in the user profile.</p>	
5.	CONT (F1) returns to CONFIGURE Interfaces screen.	

24.6

Hidden Point Measurement Devices

Description

Hidden point measurement devices can be used to measure distances, angles and azimuths to points which are not accessible by means of GPS. A Bluetooth housing can be used to provide a wireless connection between the receiver and a Bluetooth enabled hidden point measurement device.

Configure hidden point connection step-by-step

The following table explains the most common settings. Refer to the stated chapter for more information on screens.

Step	Description	Refer to chapter
1.	Refer to "22.2 Accessing Configuration Interfaces" to access CONFIGURE Interfaces .	
2.	In CONFIGURE Interfaces highlight an interface which has a hidden point measurement device attached.	23
3.	CTRL (F4) to access CONFIGURE RS232 Connection .	
4.	CONFIGURE RS232 Connection <Type:> The type of hidden point measurement device highlighted when CONFIGURE RS232 Connection was accessed. <Bluetooth:> GPS1200 receivers detect automatically if the attached devices is bluetooth capable. Some devices ask for the identification number of the Bluetooth. The identification number of Leica's Bluetooth is 0000. The field is unavailable for RX1250 with SmartAntenna.	

Step	Description	Refer to chapter
	<ID Address:> Available for <Bluetooth: Yes> . The ID address of the Bluetooth device to be used. Refer to the device's user manual for information about the ID address.	
	SRCH (F4) available for <Bluetooth: Yes> , to search for all available Bluetooth devices. If more than one Bluetooth device is found a list of available devices is provided.	
5.	CONT (F1) returns to CONFIGURE Interfaces .	

24.7

GPRS / Internet Devices



Description

GPRS / Internet devices can be used to access the Internet from a GPS1200 receiver.

Configure Internet connection step-by-step

The following table explains the most common settings. Refer to the stated chapter for more information on screens.

Step	Description	Refer to chapter
1.	Refer to "22.2 Accessing Configuration Interfaces" to access CONFIGURE Interfaces .	
2.	In CONFIGURE Interfaces highlight the Internet interface which has a GPRS / Internet device attached.	22.11
3.	CTRL (F4) to access CONFIGURE GPRS/Internet Connection .	
4.	CONFIGURE GPRS/Internet Connection <Device:> The type of GPRS / Internet device highlighted when CONFIGURE GPRS/Internet Connection was accessed. <Bluetooth:> GPS1200 receivers detect automatically if the attached devices is bluetooth capable. Some devices ask for the identification number of the Bluetooth. The field is unavailable for RX1250 with SmartAntenna. <ID Address:> Available for <Bluetooth: Yes> . The ID address of the Bluetooth device to be used. Refer to the device's user manual for information about the ID address.	

Step	Description	Refer to chapter
	<APN:> Available for some GPRS / Internet devices. The Access Point Name of a server from the network provider, which allows access to data services. Contact your provider to get the correct APN. Mandatory for using GPRS.	
	CODES (F3) Available for digital cellular phones of GSM technology. Accesses CONFIGURE GSM Codes to enter the Personal Identification Number of the SIM card. If the PIN is locked for any reason, for example the wrong PIN was entered, input the Personal UnblockKing code for access to the PIN.	
	SRCH (F4) Available for <Bluetooth: Yes> , to search for all available Bluetooth devices. If more than one Bluetooth device is found a list of available devices is provided.	
	SHIFT CMND (F4) allows AT commands to be sent to the GPRS / Internet device.	Appendix J
5.	CONT (F1) returns to CONFIGURE Interfaces .	

24.8

Internet / Ethernet



The Internet connection is available on every GRX1200 Classic receiver.
The Ethernet connection is available on the GRX1200 Pro and GRX1200 GG Pro.

Description

Internet

The Internet connection allows for the GPS1200 receivers except GRX1200 Pro/GRX1200 GG Pro to be connected to the Internet to receive real-time data. A GPRS / Internet device must be attached to the receiver.

Ethernet

The Ethernet connection allows for the GRX1200 Pro/GRX1200 GG Pro to be connected to the Internet/intranet for remote access. The Ethernet device resides inside the GRX1200 Pro/GRX1200 GG Pro and is connected to the intranet/Internet via the port NET on the receiver. The physical port NET is divided into three logical NET ports NET1, NET2 and NET3 which can each be configured separately. IP address ranges can be defined to prevent users with an IP address outside these ranges from accessing the receiver.

Requirements

For Internet

- **<Internet:>** in **CONFIGURE Internet Interface.**
 - **<Port: NETx>** in **CONFIGURE Real-Time Mode**
-

**Configure port NET
step-by-step**

The following table explains the most common settings. Refer to the stated chapter for more information on screens.

Step	Description	Refer to chapter
1.	Refer to "22.2 Accessing Configuration Interfaces" to access CONFIGURE Interfaces .	
2.	CONFIGURE Interfaces Highlight an interface which has an Internet / Ethernet device attached.	23
3.	CTRL (F4) to access CONFIGURE Set NET Port .	
4.	CONFIGURE Set NET Port, General page <Name:> The name of the port NET that was attached to the interface that was highlighted when this page was accessed. <User:> How the GPS1200 receiver will operate in the Internet. <User: Client> must be selected when using NTRIP as Internet application. Inside the Internet NTRIP Clients and NTRIP Servers are considered as clients. <Server:> The server to be accessed in the Internet. Opening the choicelist accesses CONFIGURE Server to Connect where new servers can be created and existing servers can be selected or edited.	34.1 24.11

Step	Description	Refer to chapter
	<p><IP Address:> The IP address of the selected <Server:> as configured in CONFIGURE Server to Connect. For <User: Server>: Output of the IP address associated with the NET port as configured in CONFIGURE Set NET Parameter</p> <p><TCP/IP Port:> The TCP/IP port number of the selected <Server:> as configured in CONFIGURE Server to Connect.</p> <p><Auto CONEC:> Available for <User: Client>. For <R-Time Mode: Rover> in CONFIGURE Real-Time Mode Allows for automatic connection between the rover and the Internet when a point is occupied during a survey. Ending the point occupation also ends the Internet connection.</p> <p>For <R-Time Mode: Reference> in CONFIGURE Real-Time Mode Automatically tries to establish a connection to the Internet for data streaming. After the streaming was interrupted for some reason, SHIFT CONEC (F4) in the Survey screen.</p>	20.5
5.	PAGE (F6) to access CONFIGURE Set NET Port, Ranges page	
6.	<p>CONFIGURE Set NET Port, Ranges page</p> <p>For <User: Server> in CONFIGURE Set NET Port, General page, the fields are input fields. The fields <Range X From:> and <Range X To:> can be used to prevent a user with an IP address outside the defined ranges from accessing the receiver.</p> <p>Enter the IP address ranges.</p>	
	CLEAR (F5) returns the fields back to their default values.	

Step	Description	Refer to chapter
7.	CONT (F1) returns to the screen from where CONFIGURE Set NET Port was accessed.	

24.9

Scanning Reference Stations

Description

CONFIGURE Scan Reference Station provides information about the reference stations, with specific types of devices attached, for example a radio, from which real-time corrections are being received. This can also be useful for finding out if anyone else in the area is using a particular radio channel.

Access step-by-step

Step	Description	Refer to chapter
1.	Refer to "22.2 Accessing Configuration Interfaces" to access CONFIGURE Interfaces .	
2.	In CONFIGURE Interfaces highlight an interface which has an appropriate device attached.	23
3.	CTRL (F4) to access CONFIGURE RS232 Connection or CONFIGURE Radio Channel .	
4.	SCAN (F5) to access CONFIGURE Scan Reference Station .	

CONFIGURE**Scan Reference Station**

Stn Id	Latency (s)	Data Format
05	0.25	Leica

CONT Q1 a ↑

CONT (F1)

To select the highlighted reference station and to continue with the subsequent screen.

CH- (F2) and CH+ (F3)

Available for scanning reference stations with radios attached. To switch the radio to one channel lower/higher than the current channel. The reference stations displayed change to those broadcasting on the new channel.

Description of columns

Column	Description
Stn ID	Station ID of available reference stations from which a signal is being received. For radios, the reference station radios transmitting on the same channel will be listed.
Latency (s)	Time delay, in seconds and configured on the reference, from when the reference collects the data to when the data is transmitted.
Data Format	Format of the data from the reference station. Refer to "22.3.3 Configuration of a Reference Real-Time Interface" for more information about data formats.

24.10

24.10.1

Configuring the Stations to Dial

Overview

Description

CONFIGURE Stations to Dial allows new stations to be created, provides a list of reference stations that can be dialled and allows existing stations to be edited.

For digital cellular phones of any technology and for modems, the phone numbers of the device at the reference station must be known. For a reference station to be dialled, a name, the phone number and, if available, the coordinates can be configured.

The configuration is possible for rover and reference digital cellular phones and modems.

24.10.2

Accessing CONFIGURE Stations to Dial

Access step-by-step

Step	Description	Refer to chapter
1.	Refer to "22.2 Accessing Configuration Interfaces" to access CONFIGURE Interfaces .	
2.	In CONFIGURE Interfaces highlight an interface which has a digital cellular phone of any technology or modem attached.	23
3.	CTRL (F4) to access CONFIGURE XX Connection .	
4.	Open the choicelist for <Station:> to access CONFIGURE Stations to Dial .	

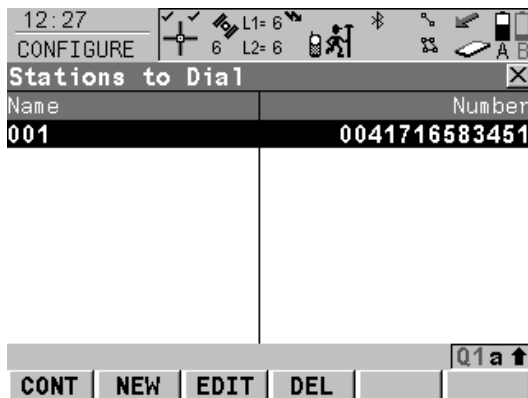
CONFIGURE
Stations to Dial**CONT (F1)**

To select the highlighted station and to return to the screen from where this screen was accessed.

NEW (F2)

To create a new station. Refer to "24.10.3 Creating a New Station to Dial".

EDIT (F3)

To edit a station. Refer to "24.10.4 Editing a Station to Dial".

DEL (F4)

To delete the highlighted station.

Description of columns

Column	Description
Name	Name of all available reference stations.
Number	Phone number of the station to dial.

24.10.3

Creating a New Station to Dial

Create new station to dial step-by-step

Step	Description
1.	Refer to "24.10.2 Accessing CONFIGURE Stations to Dial" to access CONFIGURE Stations to Dial .
2.	NEW (F2) to access CONFIGURE New Station to Dial .
3.	<p>CONFIGURE New Station to Dial</p> <p><Name:> A unique name for the new reference station to be dialled. The name may be up to 16 characters long and may include spaces. Input optional.</p> <p><Number:> The number of the reference station to dial. If the survey is to be undertaken across country borders it is necessary to input the phone number using standard international dialing codes. For example, +41123456789. Otherwise it can be input as a standard digital cellular phone number.</p> <p><Protocol:> Available for digital cellular phones of GSM technology. The configured protocol of the digital cellular phone of GSM technology. <Protocol: Analog> For conventional phone networks. <Protocol: ISDN v.110> For GSM networks. Type in the number to be dialled.</p>
4.	<p>Are the approximate coordinates of the reference station to be typed in?</p> <ul style="list-style-type: none"> • If yes, continue with step 5. • If no, continue with step 6.
5.	<p>CONFIGURE New Stations to Dial</p> <p><Enter Coords: Yes> Type in the coordinates of the reference station.</p>
	COORD (F2) views other coordinate types.

Step	Description
	SHIFT ELL H or SHIFT ORTH (F2) Available for local coordinates. Changes between the ellipsoidal and the orthometric height.
6.	STORE (F1) returns to the screen from where CONFIGURE New Points to Dial was accessed.

24.10.4

Editing a Station to Dial

Access step-by-step

Step	Description
1.	Refer to "24.10 Configuring the Stations to Dial" to access CONFIGURE Stations to Dial .
2.	EDIT (F3) to access CONFIGURE Edit Station to Dial .
3.	All following steps are identical with the creation of a new station to dial. Refer to "24.10.3 Creating a New Station to Dial". Follow the instructions from step 3. onwards.

24.11

24.11.1

Configuring the Server to Connect

Overview

Description

CONFIGURE Server to Connect allows new servers to be created, provides a list of servers that can be accessed in the Internet and allows existing servers to be edited. For servers to be accessed in the Internet, the IP address and the TCP/IP port must be known. For a server to be accessed, a name can be configured.

24.11.2

Accessing CONFIGURE Server to Connect

Access step-by-step

Step	Description	Refer to chapter
1.	Refer to "22.2 Accessing Configuration Interfaces" to access CONFIGURE Interfaces .	
2.	In CONFIGURE Interfaces highlight an interface which has an Internet/Ethernet interface attached.	23
3.	CTRL (F4) to access CONFIGURE XX Connection .	
4.	Open the choicelist for <Server:> to access CONFIGURE Server to Connect .	

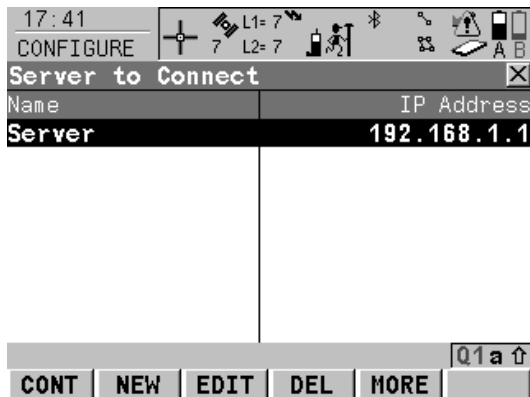
CONFIGURE
Server to Connect**CONT (F1)**

To select the highlighted server and to return to the screen from where this screen was accessed.

NEW (F2)

To create a new server. Refer to "24.11.3 Creating a New Server".

EDIT (F3)

To edit a server. Refer to "24.11.4 Editing a Server to Connect".

DEL (F4)

To delete the highlighted server.

MORE (F5)

To change between the IP Address and the TCP/IP Port of the server.

Description of columns

Column	Description
Name	Name of all available servers.
IP Address	IP addresses of all available servers.
TCP/IP Port	TCP/IP Port numbers of all available servers.

24.11.3

Creating a New Server

Create new server to be accessed step-by-step

Step	Description
1.	Refer to "24.11.2 Accessing CONFIGURE Server to Connect" to access CONFIGURE Server to Connect .
2.	NEW (F2) to access CONFIGURE New Server .
3.	CONFIGURE New Server <Name:> A unique name for the new server to be accessed. The name may be up to 16 characters long and may include spaces. <IP Address:> Type in the IP address of the server to be accessed in the Internet. <TCP/IP Port:> The port of the Internet server through which the data is provided. Each server has several ports for various services..
4.	STORE (F1) returns to the screen from where CONFIGURE New Points to Dial was accessed.

24.11.4

Editing a Server to Connect

Access step-by-step

Step	Description
1.	Refer to "24.11 Configuring the Server to Connect" to access CONFIGURE Server to Connect .
2.	EDIT (F3) to access CONFIGURE Edit Server .
3.	All following steps are identical with the creation of a new server. Refer to "24.11.3 Creating a New Server". Follow the instructions from step 3. onwards.

25 Tools...\Format Memory Device

Description

Allows the CompactFlash card, the internal memory, if fitted, and the System RAM to be formatted. All data will be erased. Refer to "Appendix B Memory Types" for more information on the types of memory devices available.

Access

Select **Main Menu: Tools...\Format Memory Device**.

TOOLS

Format Memory Device

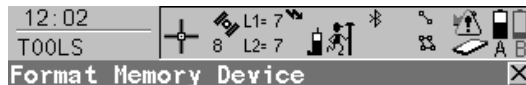

Memory Device: **CF Card** ⏪ ⏩

Format Method: **Format Quick** ⏪ ⏩



CONT (F1)

To format a memory device and return to the screen from where this screen was accessed.

PROGS (F4)

To format the application programs memory.

SYSTEM (F5)

To format System RAM memory.

Description of fields

Field	Option	Description
<Memory Device:>		The type of memory to be formatted.

Field	Option	Description
	Output	For receivers without internal memory.
	CF Card or Internal Memory	For receivers with CompactFlash card and internal memory.
<Format Method:>	Format Quick	After formatting, data is not visible any more but still exists on the memory device and is overwritten as and when required.
	Format Complete	Data is fully deleted.

Next step

IF	THEN
the CompactFlash card or internal memory is to be formatted	CONT (F1) to format the selected memory device and return to GPS1200 Main Menu .
the application programs memory is to be formatted	PROGS (F4) to format the application programs memory. All load-able application programs are deleted.
the System RAM is to be formatted	SYSTEM (F5) to format the System RAM.



If the System RAM is formatted all system data such as almanac, user defined configuration sets, user defined antennas, codelists, geoid field files and CSCS field files will be lost.

26 Tools...\Transfer Objects...

Description

This chapter describes the basic procedure for transferring objects between the CompactFlash card, and the internal memory, if fitted, and the System RAM. Refer to "Appendix C Directory Structure of the Memory Device" for information about file types and locations of files on the CompactFlash card.

Access

Select **Main Menu: Tools...\Transfer Objects...XX**.

TOOLS Transfer XX

The available fields on the screen depend on the option selected in **Main Menu: Tools...\Transfer Objects...**

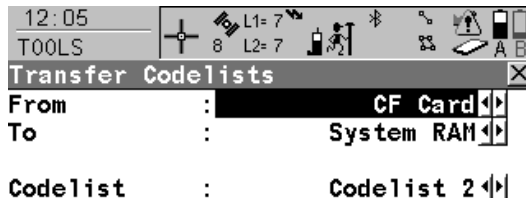

CONT (F1)

To transfer an object and return to the screen from where this screen was accessed.

ALL (F3)

Available for some transfer object options. To transfer all objects.



Description of fields

Field	Option	Description
<From:>	CF Card System RAM Internal Memory	Memory device to transfer object from. Transfer from CompactFlash card. Transfer from System RAM. Available unless object to transfer is a job. Transfer from internal memory, if fitted. Available if the object to transfer is a job.
<To:>	Output	Memory device to transfer object to. Memory device not selected in <From:>.
<Codelist:>	Choicelist	To select the codelist to be transferred.
<Config Set:>	Choicelist	To select the configuration set to be transferred.
<Coord Sys:>	Choicelist	To select the coordinate system to be transferred.
<File:>	Choicelist	To select the geoid field file, the CSCS field file, the entire contents of the System RAM or the PZ-90 transformation (only for GLONASS sensors) to be transferred, depending on the transfer option chosen.

Field	Option	Description
	 Output	<p>Each new System1200 firmware will include the latest PZ-90 transformation, so that is normally not necessary to transfer a PZ-90 transformation to or from a sensor.</p> <p>PZ90 is the GLONASS reference frame. For a combined processing (GPS & GLONASS) a 7-parameter Helmert transformation is necessary to transform PZ90 into WGS84. The values for this transformation are hard-coded, but can be changed by importing the file "PZ90trafo.dat" that is provided by LGO.</p> <p>The select the modem or GSM station or the server to be transferred as a binary file. CDMA stations are also transferred.</p>
<Format File:>	Choicelist	To select the format files to be transferred.
<Job:>	Choicelist	Available for receivers with internal memory. To select the job to be transferred between CF card and internal memory.
<Antenna:>	Choicelist	To select the antenna records to be transferred.

Next step

IF all XX	THEN
are to be transferred	ALL (F3) transfers all objects in list.

IF all XX	THEN
are not to be transferred	CONT (F1) transfers selected object.

27

Tools...\Upload System Files...

27.1

Application Programs

Description

Application program uploads are possible from the CompactFlash card to the application programs memory. These files are stored in the \SYSTEM directory of the memory device and use the extension *.a*.

Access

Select **Main Menu: Tools...\Upload System Files...\Application Programs.**

TOOLS

Upload Application Programs

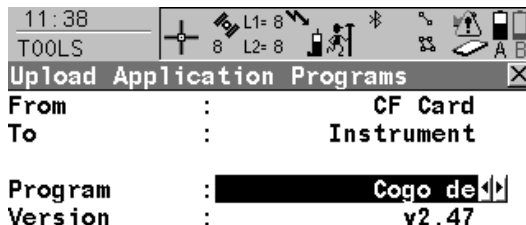

11:38
TOOLS
Upload Application Programs

From : CF Card
To : Instrument

Program : Cogo de
Version : v2.47

CONT (F1)

To upload an application program and return to the screen from where this screen was accessed.

DEL (F4)

To delete an application program.



CONT [] DEL [] Q1 a ↑

Description of fields

Field	Option	Description
<From:>	Output	Upload from CompactFlash card.
<To:>	Output	Upload to application programs memory.
<Program:>	Choicelist	List of program files stored on the CompactFlash card.
<Version:>	Output	Version of the program file chosen.

Next step

CONT (F1) uploads the selected application program.

27.2

System Languages

Description

System language uploads are possible from the CompactFlash card to the instrument. These files are stored in the \SYSTEM directory of the active memory device and use an extension that is individual to each language.

Access

Select **Main Menu: Tools...\Upload System Files...\System Languages.**

TOOLS

Upload System Languages

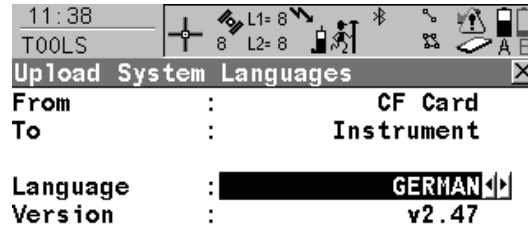

CONT (F1)

To upload a system language and return to the screen from where this screen was accessed.

DEL (F4)

To delete a language from the System RAM.



Description of fields

Field	Option	Description
<From:>	Output	Upload from CompactFlash card.
<To:>	Output	Upload to the instrument.

Field	Option	Description
<Language:>	Choicelist	List of language files stored on the CompactFlash card.
<Version:>	Output	Version of the language file.

Next step

CONT (F1) uploads the selected language.



It is not possible to have more than three language files stored on the instrument. English is always available as the default language and cannot be deleted.

27.3

Instrument Firmware

Description

Firmware uploads are possible from the CompactFlash card to the instrument, SmartAntenna or RX1200. These files are stored in the \SYSTEM directory of the active memory device and use the extension *.fw.



SmartAntenna must always be connected to RX1250 when uploading the firmware. Connect SmartAntenna and RX1250 via cable.

Uploading the firmware takes some time.

Access

Select **Main Menu: Tools...\Upload System Files...\Instrument Firmware.**

TOOLS

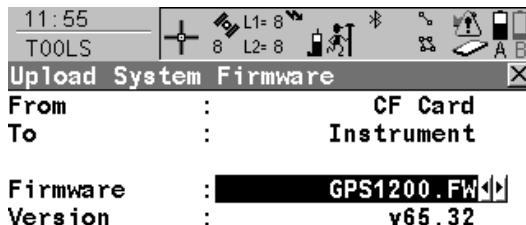
Upload System
Firmware

CONT (F1)

To upload firmware and return to the screen from where this screen was accessed.

Description of fields

Field	Option	Description
<From:>	Output	Upload from CompactFlash card.
<To:>	Output	Upload to the instrument or RX1200.
<Firmware:>	Choicelist	List of firmware files stored on the CompactFlash card. The RX1200 firmware is for RX1210 and RX1210T. This software covers display, sound and communication settings of the RX1210 and RX1210T. The available languages for the RX1200 are included in the firmware.
<Version:>	Output	Version of the firmware file.

Next step

CONT (F1) to upload firmware.

28**Tools...\Calculator****28.1****Overview****Description**

The calculator can be used to perform the following arithmetic operations such as

- addition, subtraction, multiplication and division
- statistics
- trigonometry, hyperbolic trigonometry and calculations with Pi
- polar, rectangular and angle conversions
- powers, logs, roots and exponential functions.

Operating modes

The calculator has two operating modes - RPN mode and Standard mode.

The arithmetic operations available are identical, the difference lies in the way information is entered, stored and displayed on the screen.

Type	Description
RPN	Reverse Polish Notation This operating mode was developed as a way of writing mathematical expressions without using parenthesis and brackets. Many scientific calculators, for example Hewlett Packard calculators, are implemented with this operating mode. Values are entered and kept in a working stack.
Standard	This operating mode is based on the principles of conventional pocket calculators. There is no stacking of values.

28.2

Accessing the Calculator

Access

Select **Main Menu: Tools...\Calculator**.

OR

Press a hot key configured to access the screen **TOOLS XX Calculator**. Refer to "6.1 Hot Keys" for information on hot keys.

OR

Press **USER**. Refer to "6.2 USER Key" for information on the **USER** key.

OR

Press **CALC** in any screen when editing an input field for numeric characters, such as **<Azimuth:>** in **COGO Traverse Input**. Refer to "28.4.4 Calling and Closing the Calculator from an Input Field for Numeric Characters".

28.3

Configuring the Calculator

Access step-by-step

Step	Description
1.	Refer to "28.2 Accessing the Calculator" to access TOOLS XX Calculator .
2.	SHIFT CONF (F2) to access TOOLS Calculator Configuration .

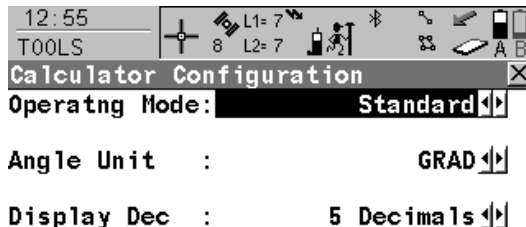
TOOLS
Calculator Configura-
tion
**CONT (F1)**

To accept changes and return to the screen from where this screen was accessed.



Description of fields

Field	Option	Description
<Operatng Mode:>	RPN	The principle of, for example, Hewlett Packard calculators. Refer to "28.1 Overview" for more information. Refer to "28.4.1 RPN Mode" for a working example.

Field	Option	Description
	Standard	The principle of conventional pocket calculators. Refer to "28.1 Overview" for more information. Refer to "28.4.2 Standard Mode" for a working example.
<Angle Unit:>	DEG RAD GRAD	The unit used for trigonometric functions in the calculator. The selection here is independent from the angle setting in CONFIGURE Units & Formats . Degrees Radians Gon
<Display Dec:>	From 0 Decimals to 10 Decimals	The number of decimal places shown in TOOLS Calculator .

Next step

CONT (F1) confirms the selections made and returns to the screen from where **TOOLS Calculator Configuration** was accessed.

28.4 Using the Calculator

28.4.1 RPN Mode

Requirements

<Operatng Mode: RPN> in **TOOLS Calculator Configuration**.

Access

Refer to "28.2 Accessing the Calculator" to access **TOOLS RPN Calculator**.

TOOLS RPN Calculator

Refer to paragraph "Working example" for information about the operating principle.

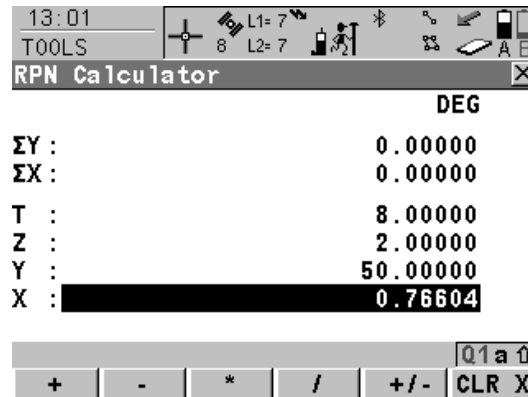

The function keys **F1-F6** are allocated seven times. Using ▲ or ▼ the various allocations can be accessed. Refer to "28.4.3 Description of Softkeys" for information about the function keys.







Description of fields

Field	Option	Description
First field on the screen	Output DEG RAD GRAD	The unit used for trigonometric functions in the calculator as configured in TOOLS Calculator Configuration . Degrees Radians Gon
< Σ Y:>	Output	The result of the sum or difference of values in <Y:> using $\Sigma+$ (F1) and $\Sigma-$ (F2).
< Σ X:>	Output	The result of the sum or difference of values in <X:> using $\Sigma+$ (F1) and $\Sigma-$ (F2).
<T:>	Output	Third stack. After an operation, the value from <Z:> is written here.
<Z:>	Output	Second stack. After an operation, the value from <Y:> is written here.
<Y:>	Output	First stack. After an operation, the value from <X:> is written here.
<X:>	User input	The value for the next operation.

Next step

SHIFT DONE (F4) returns to **GPS1200 Main Menu**.

Working exampleTask: Calculate $(3 + 5) / (7 + 6)$.

Step	Description
1.	Type in 3.
2.	ENTER
3.	Type in 5.
4.	ENTER
	<Y: 3>, <X: 5>
5.	+ (F1)
	<X: 8>
6.	Type in 7.
7.	ENTER
	<Y: 8>, <X: 7>
8.	Type in 6.
9.	ENTER
	<Z: 8>, <Y: 7>, <X: 6>
10.	+ (F1)
	<Y: 8>, <X: 13>
11.	/ (F4)
	<X: 0.61538>

28.4.2

Standard Mode

Requirements

<Operatng Mode: Standard> in **TOOLS Calculator Configuration**.



Access

Refer to "28.2 Accessing the Calculator" to access **TOOLS Standard Calculator**.

TOOLS Standard Calculator

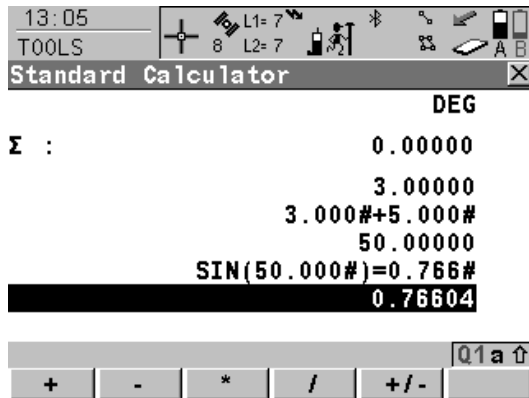
Refer to paragraph "Working example" for information about the operating principle.



The function keys **F1-F6** are allocated seven times. Using  or  the various allocations can be accessed. Refer to "28.4.3 Description of Softkeys" for information about the function keys.

Description of fields

Field	Option	Description
First field on the screen	Output	The unit used for trigonometric functions in the calculator as configured in TOOLS Calculator Configuration .
	DEG	Degrees

Field	Option	Description
	RAD GRAD	Radians Gon
< Σ >	Output	The result of the sum or difference of values in the last field on the screen using $\Sigma+$ (F1) and $\Sigma-$ (F2).
Third to sixth field on the screen	Output	Previously entered value OR Latest operation including result # indicates that the value is cut after the third decimal.
Last field on the screen	User input	The value for next operation or result from latest operation.







Next step

SHIFT DONE (F4) returns to **GPS1200 Main Menu**.

Working example

Task: Calculate $(3 + 5) / (7 + 6)$.

Step	Description
1.	Type in 3.
2.	ENTER
3.	+ (F1)
4.	Type in 5.
5.	ENTER
	Last field on the screen displays 8.00000 .

Step	Description
6.	 such that STO (F1) is visible.
7.	STO (F1)
8.	 such that + (F1) is visible.
9.	Type in 7.
10.	ENTER
11.	+ (F1)
12.	Type in 6.
13.	ENTER
	Last field on the screen displays 13.00000 .
	Remember 13.00000 .
14.	 such that REC (F2) is visible.
15.	REC (F2) to recall 8.00000.
16.	ENTER
17.	 such that / (F4) is visible.
18.	/ (F4)
19.	Type in 13.
20.	ENTER
	Last field on the screen displays 0.61538 .

28.4.3

Description of Softkeys

Overview of softkeys

The softkeys shown and described are those of **<Operatng Mode: RPN>**. Most of the softkeys are identical and their functionality is similar to that for **<Operatng Mode: Standard>**.

The function keys **F1-F6** are allocated seven times with softkeys. Using \blacktriangle or \blacktriangledown the various allocations can be accessed.

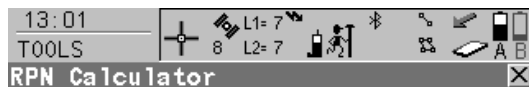

DEG

ΣY : 0.00000
 ΣX : 0.00000
T : 8.00000
Z : 2.00000
Y : 50.00000
X : 0.76604

					Q1 a \uparrow
+	-	*	/	+/-	CLR X
$\Sigma+$	$\Sigma-$	MEAN	SDEV		CLR \bar{y}
SIN	COS	TAN	ASIN	ACOS	ATAN
$^{\circ}$ DMS	$^{\circ}$ DEC	PI		D->R	R->D
POLAR	RECT	SQRT	X ²	1/X	Y ^X
LOG	10 ^X	LN	e ^X		Y ^X
STO	RCL	X \leftrightarrow Y	LASTX		CLEAR
HELP	CONF		DONE		QUIT

Description of softkeys

First level



+ (F1)

To add $\langle X \rangle$ and $\langle Y \rangle$.

- (F2)

To subtract $\langle X \rangle$ from $\langle Y \rangle$.

*** (F3)**

To multiply $\langle X \rangle$ by $\langle Y \rangle$.

/ (F4)

To divide $\langle Y \rangle$ by $\langle X \rangle$.

+/- (F5)

To change between positive and negative algebraic sign for $\langle X \rangle$.

CLR X (F6)

To clear $\langle X \rangle$.

▼ to access the **Second level**



Σ+ (F1)

To add $\langle X \rangle$ to $\langle \Sigma X \rangle$ and $\langle Y \rangle$ to $\langle \Sigma Y \rangle$.

Σ- (F2)

To subtract $\langle X \rangle$ from $\langle \Sigma X \rangle$ and $\langle Y \rangle$ from $\langle \Sigma Y \rangle$.

MEAN (F3)

To calculate the mean $\langle \Sigma X \rangle$.

SDEV (F4)

To calculate the standard deviation for $\langle \Sigma X \rangle$.

CLRΣ (F6)

To clear $\langle \Sigma X \rangle$ and $\langle \Sigma Z \rangle$.

▼ to access the **Third level**

SIN	COS	TAN	ASIN	ACOS	ATAN
-----	-----	-----	------	------	------

SIN (F1)To calculate sine of $\langle X \rangle$.**COS(F2)**To calculate cosine of $\langle X \rangle$.**TAN (F3)**To calculate tangent of $\langle X \rangle$.**ASIN (F4)**To calculate arcsine of $\langle X \rangle$.**ACOS (F5)**To calculate arccosine of $\langle X \rangle$.**ATAN (F6)**To calculate arctangent of $\langle X \rangle$.▼ to access the **Fourth level**

°DMS	°DEC	PI		D->R	R->D
------	------	----	--	------	------

°DMS (F1)

To convert decimal degrees into dd.mm.ss.

°DEC(F2)

To convert dd.mm.ss into decimal degrees.

PI (F3)To insert $\langle X: 3.1415926536 \rangle$. The number of decimals depends on the selection for **<Display Dec:>** in **TOOLS Calculator Configuration**.**D -> R (F5)**

To convert degrees into radians.

R -> D (F6)

To convert radians into degrees.

▼ to access the **Fifth level**

POLAR **RECT** **SQRT** **X^2** **1/X** **Y^X**

POLAR (F1)

Conversion of rectangular coordinates into polar coordinates. The y coordinate must be visible in <Y:> and the x coordinate in <X:> when pressing this key. The angle is displayed in <Y:> and the distance in <X:>.

RECT(F2)

Conversion of polar coordinates into rectangular coordinates. The angle must be visible in <Y:> and the distance in <X:> when pressing this key. The y coordinate is displayed in <Y:>, the x coordinate in <X:>.

SQRT (F3)

To calculate $\sqrt{\text{<X:>}}$.

X^2 (F4)

To calculate <X:>^2 .

1/X (F5)

To inverse <X:>.

Y^X (F6)

To calculate $\text{<Y:>}^{\text{<X:>}}$.

▼ to access the **Sixth level**

LOG **10^X** **LN** **e^X** **Y^X**

LOG (F1)

To calculate the $\log_{10} \text{<X:>}$.

10^X(F2)

To calculate $10^{\text{<X:>}}$.

LN (F3)

To calculate the $\log_e \text{<X:>}$.

e^X (F4)

To calculate $e^{<X>}$.

Y^X (F6)

To calculate $<Y>^{<X>}$.

▼ to access the **Seventh level**

**STO (F1)**

To store $<X>$ to the memory. Up to ten values can be stored.

RCL (F2)

To recall a value for $<X>$ from the memory. Up to ten values can be recalled.

X<>Y (F3)

To swap the values for $<X>$ and $<Y>$.

LASTX (F4)

To recall the last $<X>$ before recent calculation.

CLEAR (F6)

To delete everything.

SHIFT to access the second level of function keys

**SHIFT CONF (F2)**

To configure the calculator.

SHIFT DONE (F4)

To return to **GPS1200 Main Menu**.

28.4.4

Calling and Closing the Calculator from an Input Field for Numeric Characters



Call and close calculator step-by-step

COGO traverse calculation is used as example.

Step	Description	Refer to chapter
1.	Select Main Menu: Programs...\COGO to access the screen COGO COGO Begin .	
2.	COGO COGO Begin Check the settings.	
3.	CONT (F1) to access COGO COGO Menu .	
4.	COGO COGO Menu Highlight Traverse .	
5.	CONT (F1) to access COGO Traverse Input .	
6.	COGO Traverse Input Highlight <Azimuth:> .	
7.	ENTER	
8.	CALC (F5) to access TOOLS XX Calculator .	
	If a value had already been typed in for <Azimuth:> , this value is taken over into the input field in TOOLS XX Calculator .	
9.	TOOLS XX Calculator	

Step	Description	Refer to chapter
	Perform the calculations.	28.4.1, 28.4.2
10.	SHIFT DONE (F4) to return to COGO Traverse Input .	
	The calculated value is taken over for <Azimuth:> .	

29

Tools...\File Viewer

Description

Allows ASCII files on the memory device to be viewed. The ASCII file can have up to 500 KB. Refer to "Appendix C Directory Structure of the Memory Device" for more information on the contents of folders on the memory device.



The \DBX directory cannot be accessed to view files.

Access

Select **Main Menu: Tools...\File Viewer**.

TOOLS

Device\Directory

Directory	Date	Time
\Code	19.10.05	08:18
\Config	19.10.05	08:05
\Convert	19.10.05	08:18
\Data	19.10.05	08:18
\dbg	19.10.05	14:35
\DBX	20.10.05	09:58
\Gps	19.10.05	08:05
\Gsi	19.10.05	08:05

CONT (F1)

To access the highlighted directory or to view the highlighted file.

DIR (F2)

Available for a directory or .. being highlighted. To access the highlighted directory or to move up one directory.

VIEW (F3)

Available for a file being highlighted. To view the highlighted file. Accesses **TOOLS View File: File Name**. Refer to "TOOLS View File: File Name".

DEL (F4)

Available for a file being highlighted. To delete the highlighted file.

MORE (F5)

To display information about the size of a directory or file.

CFCRD (F6) or INTL (F6)

Available for receivers with internal memory. To change between viewing jobs stored on the CompactFlash card or internal memory.

Description of columns

Column	Description
First	Directories and files are displayed if available. The file extension is shown for files. \ at the beginning of a line indicates a directory. .. is displayed at the top of the list if a directory has been accessed.
Second	Date of the directory or file.
Third	Time of the directory or file.

Next step

IF	THEN
the screen is to be quit	ESC to return to GPS1200 Main Menu .

IF	THEN
a directory is to accessed	highlight the directory and DIR (F2) .
a file is to be viewed	highlight the file and VIEW (F3) . Refer to "TOOLS View File: File Name".

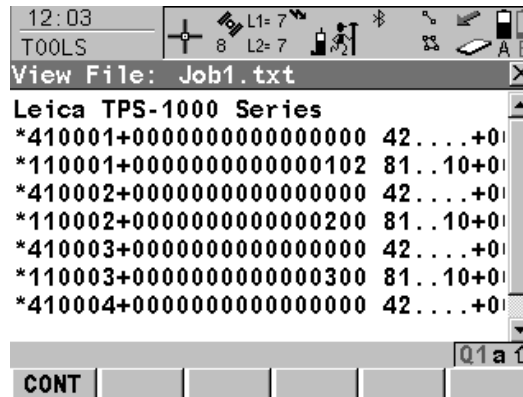
TOOLS**View File: File Name****CONT (F1)**

To return to the screen from where this screen was accessed.

Keys

Keys	Function
▲	Moves up.
▼	Moves down.
▶	Moves right.

Keys	Function
	Moves left.

Next step

CONT (F1) returns to the screen from where **TOOLS View File: File Name** was accessed.

30

Tools...\Licence Keys

Description

A licence key can be used to activate application programs and protected options and can be used to define the expiry date of the software maintenance. Refer to "31.4 STATUS: System Information" to find out how to check the expiry date of the software maintenance.

A licence key is required for:

Application programs	Protected options
<ul style="list-style-type: none">• COGO Area Division• DTM Stakeout• DXF Export• Reference Plane• Reference Line• RoadRunner• Survey Cross Section• Volume Calculations	<ul style="list-style-type: none">• GPS Survey functionality on RX1250• Some OWI messages

A licence key file can be uploaded to the receiver/RX1250. To upload a licence key file the file should be located on the \SYSTEM directory of the CompactFlash card. Licence key files use the naming convention L_123456.key, where 123456 is the instrument serial number. Licence keys can also be typed in manually in **Main Menu: Tools...\Licence Keys** or the first time the application program is started.

Access

Select **Main Menu: Tools...Licence Keys**.

OR

Select an application program not yet activated.

TOOLS

Enter Licence Key

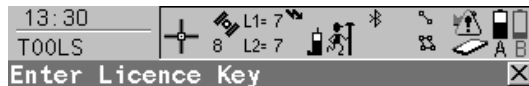

Method : **Manual Entry of Key**
Key : **4H16F9PHWE0WRB**

CONT (F1)

To accept changes and return to **GPS1200 Main Menu** or continue with application program.

SHIFT DEL (F4)

To delete all licence keys on the receiver/RX1250.



Description of fields

Field	Option	Description
<Method:>		The method used to input the licence key to activate the application program or the protected options or the software maintenance.
	Upload Key File	The licence key file is uploaded from the Compact-Flash card. The licence key file must be stored in the \SYSTEM directory on the CompactFlash card.

Field	Option	Description
	Manual Entry of Key	Allows the licence key to be typed in manually.
<Key:>	User input	Available for <Method: Manual Entry of Key >. The licence key required to activate an application program. Entry is not case sensitive.

Next step

CONT (F1) returns to **GPS1200 Main Menu** or continues with selected application program.

31 STATUS

31.1 STATUS Functions

Description

The STATUS functions help using the receiver by showing the state of many receiver functions. All fields are output fields. Unavailable information is indicated by ----.

Access

Press **USER** and then **STAT (F3)**. Refer to "6.2 USER Key" for information on the **USER** key.

**STATUS
Status Menu**

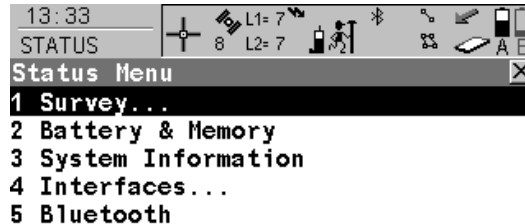

CONT (F1)

To select the highlighted option and to continue with the subsequent screen.



**Description of the
STATUS functions**

STATUS function	Description	Refer to chapter
Survey...	Information related to an active survey.	31.2

STATUS function	Description	Refer to chapter
Battery & Memory	Information related to usage and status of battery and memory.	31.3
System Information	Information related to the instrument hardware and firmware.	31.4
Interfaces...	<ul style="list-style-type: none"> Information related to the configuration and use of interfaces, ports and devices. 	31.5
	<ul style="list-style-type: none"> Information related to the incoming data from active devices. 	
Bluetooth	Information related to the configuration and use of Bluetooth interfaces.	31.6

31.2

STATUS: Survey...

31.2.1

Satellite Status

Description

This screen shows information related to the satellites ordered by the elevation angle.

Access

Select **STATUS: Survey...Satellite Status**. Refer to "31.1 STATUS Functions" on how to access the STATUS menu.

OR

Press a hot key configured to access the screen **STATUS Satellites**. Refer to "6.1 Hot Keys" for information on hot keys.

OR

Press **USER**. Refer to "6.2 USER Key" for information on the **USER** key.

OR

Tap the number of visible satellites icon. Refer to the GPS1200 System Field Manual for information on icons.

OR

Tap the contributing satellites icon. Refer to the GPS1200 System Field Manual for information on icons.

STATUS Satellites, Satellites page; STATUS Satellites, Rover page

As shown below, the name of the page changes depending on the active receiver configuration.

Name of page	Description
Satellites page	<ul style="list-style-type: none"> • Receiver is configured for static operations. • Receiver is configured for post-processed kinematic operations. • Receiver is configured for real-time reference operations.

Name of page	Description
Rover page	<ul style="list-style-type: none"> Receiver is configured for real-time rover operations.

Sat	Elev	Azimuth	S/N 1	S/N 2
G13	↑ 80	260	50	42
R1	↓ 71	47	48	36
G23	↓ 60	56	50	41
G4	↑ 56	280	50	40
G24	↓ 55	193	50	40
R2	↑ 39	310	45	34
G20	↓ 30	105	47	33

CONT (F1)

To exit **STATUS Satellites**.

GPS X / GPS ✓ (F2)

To hide or show the GPS satellites (shown by the prefix G).

Available for GX1230 GG,ATX1230 GG when <Sat System: GPS & Glonass> is configured in **CONFIGURE Satellite Settings**.

GLO X / GLO ✓ (F3)

To hide or show the GLONASS satellites (shown by the prefix R).

Available for GX1230 GG,ATX1230 GG when <Sat System: GPS & Glonass> is configured in **CONFIGURE Satellite Settings**.

HEALTH (F4)

To view the numbers of satellites categorised in good, bad and unavailable.

MORE (F5)

To open and close a window showing the date of the used almanac, the number of satellites tracked as shown on the skyplot and the number of all satellites available above the cut off elevation mask as shown on the skyplot.

PAGE (F6)

To change to another page on this screen.

Description of columns

Column	Description
Sat	The Pseudo Random Noise number (GPS) or the Slot number (GLONASS) of the satellites.
Elev	The elevation angle in degrees. The arrows indicate if the satellite is rising or falling.
Azmth	The azimuth of the satellite.
S/N 1 and S/N 2	The signal to noise ratio on L1 and L2. The number is shown in brackets if the signal is currently not being used in the position calculations.

Next step

PAGE (F6) changes to the **Skyplot** page. Refer to paragraph "STATUS Satellites, Skyplot page".

**STATUS
Satellites,
Skyplot page**

The skyplot shows satellite information in a graphical way. Satellites below the **<Cut Off Angle:>** configured in **CONFIGURE Satellite Settings** are marked grey.

The part of the skyplot between the 0° elevation and the cut-off angle is marked grey.

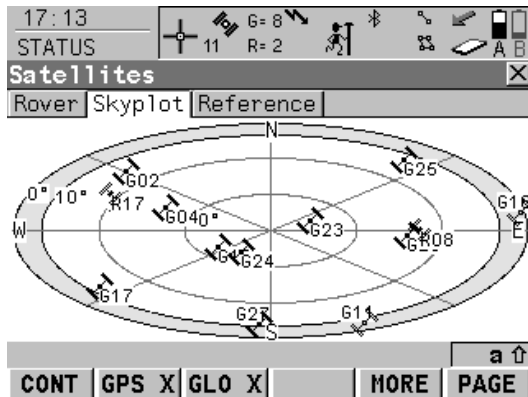

CONT (F1)

To exit **STATUS Satellites**.

GPS X / GPS ✓ (F2)

To hide or show the GPS satellites (shown by the prefix G).

Available for GX1230 GG,ATX1230 GG when **<Sat System: GPS & Glonass>** is configured in **CONFIGURE Satellite Settings**.

GLO X / GLO ✓ (F3)

To hide or show the GLONASS satellites (shown by the prefix R).

Available for GX1230 GG,ATX1230 GG when **<Sat System: GPS & Glonass>** is configured in **CONFIGURE Satellite Settings**.

MORE (F5)

To open and close a window showing the date of the used almanac, the number of satellites tracked as shown on the skyplot and the number of all satellites available above the cut off elevation mask as shown on the skyplot.

PAGE (F6)

To change to another page on this screen.

Description of symbols

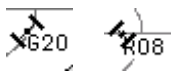
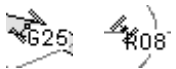
Symbol	Description
	Satellites above the <Cut Off Angle:> configured in CONFIGURE Satellite Settings .
	Satellites below the <Cut Off Angle:> configured in CONFIGURE Satellite Settings .

Next step

IF	THEN
the receiver is a real-time rover	PAGE (F6) changes to the Reference page. Refer to paragraph "STATUS Satellites, Reference page".
the receiver is not a real-time rover	CONT (F1) exits STATUS Satellites .

STATUS Satellites, Reference page

The information about the satellites at the reference shown on this page is identical with the information shown on **STATUS Satellites, Rover** page. Refer to paragraph "STATUS Satellites, Satellites page; STATUS Satellites, Rover page".

Next step

CONT (F1) exits **STATUS Satellites**.

31.2.2

Real-Time Status

Description

This screen shows information related to real-time data, for example the data link and the device used to transfer real-time data.

The name of the screen changes depending on the configuration:

Real-time rover configuration:	STATUS Real-Time Input
Real-time reference configuration with one real-time device:	STATUS Real-Time Output
Real-time reference configuration with two real-time devices:	STATUS Real-Time Output 1 and STATUS Real-Time Output 2

For simplicity, the screen is named here as **STATUS Real-Time**. Differences depending on the configurations are outlined.

Access

This screen is accessible for **<R-Time Mode: Rover>** and **<R-Time Mode: Reference>** in **CONFIGURE Real-Time Mode**.

Select **STATUS: Survey...\Real-Time Status**.

OR

Press a hot key configured to access the screen **STATUS Real-Time**. Refer to "6.1 Hot Keys" for information on hot keys.

OR

Press **USER**. Refer to "6.2 USER Key" for information on the **USER** key.

OR

Tap the real-time device and real-time status icon. Refer to the GPS1200 System Field Manual for information on icons.

STATUS
Real-Time,
General page

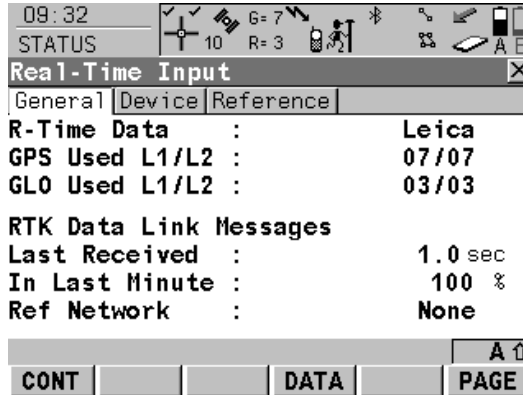

CONT (F1)

To exit **STATUS Real-Time**.

DATA (F4)

To view the data being received. Depending on **<R-Time Data:>**, the shown data differ. Refer to paragraph "STATUS Real-Time Input Data".

REF2 (F5) and REF1 (F5)

Available for **<R-Time Mode: Reference>** with two real-time devices configured.

To change between the status information for both real-time devices.

PAGE (F6)

To change to another page on this screen.

Description of fields

Field	Description
R-Time Data	The received real-time data format message type.
<GPS used L1/L2:>	The number of satellites on L1 and L2 being used in the current position solution.
<GLO used L1/L2:>	Available for GX1230 GG/ATX1230 GG/GRX1200 GG Pro when <Sat System: GPS & GLONASS> is configured in CONFIGURE Satellite settings . The number of satellites on L1 and L2 being used in the current position solution.

Field	Description
<Last Sent:>	Available for <R-Time Mode: Reference>. Seconds since the last message from the reference was sent.
<Last Received:>	Available for <R-Time Mode: Rover>. Seconds since the last message from the reference was received.
In Last Minute	Available for <R-Time Mode: Rover>. The percentage of real-time data received from the reference compared with the data received from the GPS antenna within the last minute. This indicates how well the datalink is working.
<Ref Network:>	Available for <R-Time Mode: Rover>. The type of reference network in use. Refer to "22.3.4 Configuration of a Rover Real-Time Interface" for information about the various reference network options.
<Output NMEA:>	Available for <R-Time Mode: Rover> unless <Ref Network: None>. NMEA positions must be send to a network. The type of NMEA message send to the reference network. If more than one message is send at a time, then all types are shown separated by comma.

Next step

PAGE (F6) changes to the Device page. Refer to paragraph "STATUS Real-Time, Device page".

STATUS

**Real-Time,
Device page**

The content of this page differs for each type of device in use.

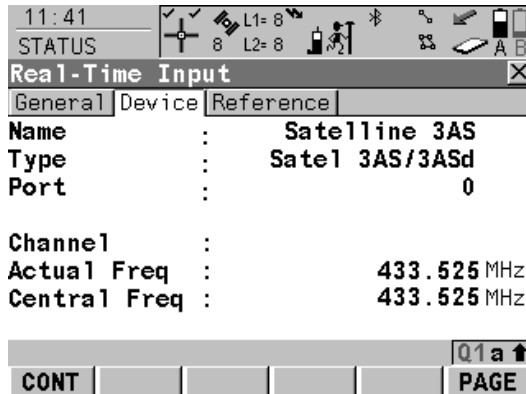

CONT (F1)

To exit STATUS Real-Time.

ACCNT (F3)

Available for SMARTgate device. To view SMARTgate account information. Accesses **STATUS SMARTgate Account Information.**

VERS (F4)

Available for SMARTgate device. To view SMARTgate version information. Accesses **STATUS SMARTgate Account Information.**

PAGE (F6)

To change to another page on this screen.

For all devices available

Description of fields

Field	Description
<Name:>	The name of the device.

For RS232

Description of fields

Field	Description
<Type:>	The type of device.

Field	Description
<Port:>	The port to which the device is connected.
<Bluetooth:>	Available if device is connected via bluetooth. Indicates the state of the connection.

For digital cellular phones and modems

Description of fields

Field	Description
<Type:>	The type of device.
<Port:>	The port to which the device is connected.
<Firmware:>	The software version of the attached digital cellular phone.
<Operator:>	The name of the network operator in which the digital cellular phone is operating.
<Status:>	The actual mode of the digital cellular phone. The options are Unknown , Detection and Registered .
<Bluetooth:>	Available if device is connected via bluetooth. Indicates the state of the connection.
<Signal:>	Indication of received signal strength of the digital cellular phone network.

For radios

Description of fields

The available fields depends on the radio type.

Field	Description
<Port:>	The port to which the device is connected.
<Type:>	The type of device.
<Channel:>	The radio channel.
<Actual Freq:>	The actual set frequency of the radio.
<Central Freq:>	The defined central frequency of the radio.
<Firmware:>	The software version of the attached radio.
<Signal:>	Indication of strength of received radio signal.

For SMARTgate boxes

Description of fields

Field	Description
<Port:>	The port to which the device is connected.
<Profile:>	The user profile being used.
<Profile No.:>	Number of the profile being used.
<Medium:>	The SMARTgate medium currently being used as configured in <Profile:>.
<Error Rate:>	The current error rate of the active medium.

For Ethernet, available for GRX1200 Pro and GRX1200 GG Pro
Description of fields

Field	Description
<IP Port:>	The logical NET port being used.
<Connected To:>	IP address of device connected to the receiver.
<Duration:>	Time since connection was established, displayed as hh:mm:ss.
<Kbytes Recvd:>	Kilobytes of data received since the connection was established.
<Kbytes Sent:>	Kilobytes of data sent since the connection was established.

Next step

PAGE (F6) changes to the **Reference** page. Refer to paragraph "STATUS Real-Time, Reference page".

STATUS
Real-Time,
Reference page

As shown below, the name of the page changes depending on the type of reference being used.

Name of page	Description
Reference page	Reference is a real reference station.
Ref (Nearest) page	Reference is the closest to the rover determined by for example LEICA GPS Spider.
Ref (i-MAX) page	Reference information are individualised Master-Auxiliary corrections determined and sent by for example LEICA GPS Spider.
Ref (MAX) page	Reference information are Master-Auxiliary corrections determined and sent by for example LEICA GPS Spider.

Name of page	Description
Ref (VRS) page	Reference is a virtual reference station.
Ref (FKP) page	Reference information are area correction parameters.

Description of fields

Field	Description
<Ref Stn ID:>	An identification for a reference station. The ID can be converted into a compact format to be send out with real-time data in all real-time data formats. It is different from the point ID of the reference station.
<Antenna Ht:>	<ul style="list-style-type: none"> For <R-Time Data: Leica>, <R-Time Data: RTCM v3.0> or <R-Time Data: RTCM X v2> with <RTCM Version: 2.3>: The antenna height at the reference from the marker to the MRP. For <R-Time Data: CMR/CMR+> and <R-Time Data: RTCM 18, 19 v2> or <R-Time Data: RTCM 18, 19 v2> with <RTCM Version: 2.2> The antenna height at the reference from the marker to the phase center. For all other <R-Time Data:>: ---- is displayed because the data format does not include information about the antenna height.
<Coords of:>	<p>The coordinates for the reference station which are transferred depend on the active real-time data format.</p> <ul style="list-style-type: none"> For real-time messages which include antenna height and antenna type: Marker.

Field	Description
	<ul style="list-style-type: none"> For real-time messages which do not include antenna Information: Phase Centre of L1.
<No.of Aux Ref:>	The number of active auxiliary reference stations from which data is received.

Next step

IF	THEN
other coordinate types are to be viewed	COORD (F2) . Local coordinates are available when a local coordinate system is active.
this screen is to be quit	CONT (F1) exits STATUS Real-Time .

STATUS Real-Time Input Data

The following provides additional information on the satellite data received via real-time message. Information of those satellites is displayed, which are used on both reference and rover.

Access

DATA (F4) on **STATUS Real-Time, General** page.

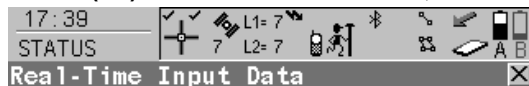

Sat PRN	:	002
Sat Time	:	17:39:27
Phase L1	:	119500413.527 cyc
Phase L2	:	93117226.102 cyc
Code L1	:	22740172.205 m
Code L2	:	22740171.625 m

CONT (F1)

To return to **STATUS Real-Time**.

SAT- (F2)

To display information about the satellite with the next smaller PRN.

SAT+ (F3)

To display information about the satellite with the next larger PRN.



Description of fields

The data being received from the satellites and the layout of the screen depend on the active real-time data format.

Field	Description
<Sat PRN:>	The PRN number (GPS) or the slot number (GLONASS) of the satellites shown with the prefix G (GPS) or R (GLONASS).
<Sat Time:>	The GPS time of the satellite.
<Phase L1:>, <Phase L2:>	The number of phase cycles from the antenna to the satellite on L1 and L2.
<Msg 18 L1:>, <Msg 18 L2:>	The uncorrected carrier phases for L1 and L2.
<Msg 20 L1:>, <Msg 20 L2:>	The carrier phase corrections for L1 and L2.
<Code L1:>, <Code L2:>	The pseudorange between the antenna to the satellite for L1 and L2.
<Msg 19 L1:>, <Msg 19 L2:>	The uncorrected pseudoranges for L1 and L2.
<Msg 21 L1:>, <Msg 21 L2:>	The pseudorange corrections for L1 and L2.
<PRC:>	Pseudorange corrections.
<RRC:>	Rate of change of the corrections.
<IODE:>	Issue Of Data Ephemeris. The identification number of the ephemeris for a satellite.

Next step

CONT (F1) returns to the screen from where **STATUS Real-Time Input Data** was accessed.

31.2.3**Current Position**

Description

This screen shows information related to the current antenna position and the speed of the antenna. For real-time rover configurations the baseline vector is also shown. MapView shows the current position in a graphical format.

Access

Select **STATUS: Survey... \Current Position**. Refer to "31.1 STATUS Functions" on how to access the STATUS menu.

OR

Press a hot key configured to access the screen **STATUS Position**. Refer to "6.1 Hot Keys" for information on hot keys.

OR

Press **USER**. Refer to "6.2 USER Key" for information on the **USER** key.

OR

Tap the position status icon. Refer to the GPS1200 System Field Manual for information on icons.

**STATUS
Position,
Position page**

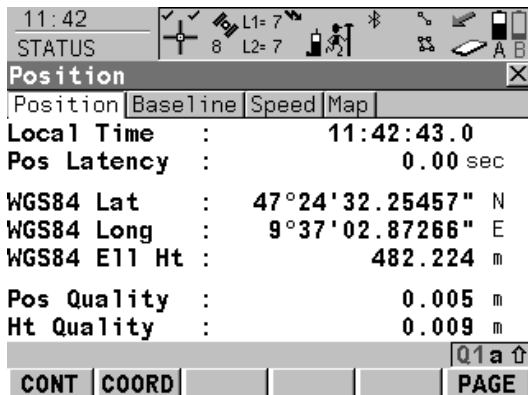

CONT (F1)

To exit **STATUS Position**.

COORD (F2)

To see other coordinate types. Local coordinates are available when a local coordinate system is active.

PAGE (F6)

To change to another page on this screen.

SHIFT ELL H (F2) and SHIFT ORTH (F2)

Available for local coordinates. To change between the ellipsoidal and the orthometric height.

Description of fields

Field	Description
<Pos Latency:>	The latency of the computed position. Latency is mainly due to time required for data transfer and computation of position. Depends on the use of the prediction mode.
Pos Quality and Ht Quality	Available for phase fixed and code only solutions. The 2D coordinate and height quality of the computed position. Refer to "9.3.1 Terminology" for information on coordinate quality.
HDOP and VDOP	Available for navigated solutions.

Next step

IF	THEN
the receiver is a real-time rover	PAGE (F6) changes to the Baseline page. Refer to paragraph "STATUS Position, Baseline page".
the receiver is not configured for real-time	PAGE (F6) changes to the Speed page. Refer to paragraph "STATUS Position, Speed page".
the receiver is a real-time reference	CONT (F1) exits STATUS Position .

**STATUS
Position,
Baseline page**

Information on the baseline vector is displayed.

Next step

PAGE (F6) changes to the **Speed** page. Refer to paragraph "STATUS Position, Speed page".

**STATUS
Position,
Speed page****Description of fields**

Field	Description
< Horizontal >	The speed over ground in the horizontal direction.
< On Bearing >	Available for local coordinate systems. The bearing for the horizontal direction related to the North direction of the active coordinate system.
< Vertical >	The vertical component of the actual velocity.

Next step
CONT (F1) exits STATUS Position.

31.2.4

Logging Status

Description

This screen shows information related to logging of raw observations, including ring buffer.

Access

Select **STATUS: Survey...Logging Status**. Refer to "31.1 STATUS Functions" on how to access the STATUS menu.

OR

Press a hot key configured to access the screen **STATUS Logging**. Refer to "6.1 Hot Keys" for information on hot keys.

OR

Press **USER**. Refer to "6.2 USER Key" for information on the **USER** key.

OR

Tap the logging information icon. Refer to the GPS1200 System Field Manual for information on icons.

STATUS
Logging,
General page

11:57			
STATUS			
Logging [X]			
General		Reference	
Logging Raw Obs	:		YES
Interval Type	:		Static
Obs in Interval	:		32
All Static Obs	:		32
All Moving Obs	:		0
Recorded DB-X Pts:			3
		Q1 a ↑	
CONT			PAGE

CONT (F1)

To exit **STATUS Logging**.

PAGE (F6)

To change to another page on this screen.

Description of fields

Field	Description
<All Static Obs:>	The number of static epochs recorded in the current job.
<All Moving Obs:>	The number of moving epochs recorded in the current job.
<Recorded DB-X Pts:>	The number of manually occupied points and auto points stored in the job.

Next step

IF	AND	THEN
at least one ring buffer is activated	-	PAGE (F6) changes to the Ring Buffer page. Refer to paragraph "STATUS Logging, Ring Buffer page".
no ring buffer is activated	the receiver is a real-time rover	PAGE (F6) changes to the Reference or Ref (VRS) page. Refer to paragraph "STATUS Logging, Reference page".
no ring buffer is activated	the receiver is not a real-time rover	CONT (F1) exits STATUS Logging .

STATUS
Logging,
Ring Buffer page

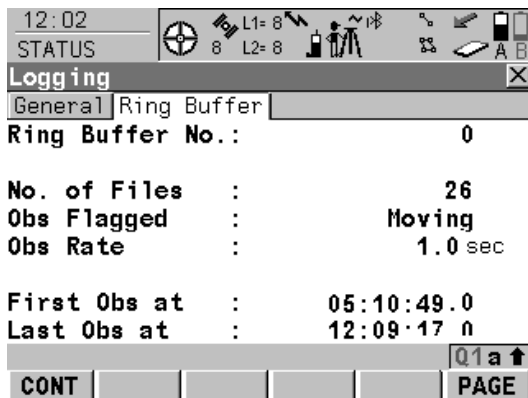

CONT (F1)
 To exit **STATUS Logging**.
PAGE (F6)
 To change to another page on this screen.

Description of fields

Field	Description
<Ring Buffer No.:>	The number of the active ring buffer.
<No. of Files:>	The number of files stored in the ring buffer.
<Obs Flagged:>	The flag assigned to the stored observations.
<Obs Rate:>	The configured observation rate by which data is logged.
<First Obs at:>	The local time when the first observation available in the ring buffer is stored.
<Last Obs at:>	The local time when the last observation available in the ring buffer is stored.

**STATUS
Logging,
Reference page**

Next step

PAGE (F6) changes to the **STATUS Reference** page or **Ref (VRS)** page.

As shown below, the name of the page changes depending on the type of reference used.

Name of page	Description
Reference page	Reference is a real reference station.
Ref (Nearest) page	Reference is the closest to the rover determined by for example LEICA GPS Spider.
Ref (i-MAX) page	Reference information are individualised Master-Auxiliary corrections determined and sent by for example LEICA GPS Spider.
Ref (MAX) page	Reference information are Master-Auxiliary corrections determined and sent by for example LEICA GPS Spider.
Ref (VRS) page	Reference is a virtual reference station.
Ref (FKP) page	Reference information are area correction parameters.

Description of fields

Field	Option	Description
<Log Static Obs:>	A time in sec	The logging rate at the reference. This information is shown if the real-time message format supports this information and raw observations are being logged at the reference.
	Not known	The real-time message format does not support this information or the information is not yet received by the rover.

Field	Option	Description
	None	Raw observations are not being logged at the reference.

Next step**CONT (F1) exits STATUS Logging.**

31.2.5

Occupation Information Status

Description

This screen shows information related to the amount of time required at a point and the amount of time spent on a point.

Access

Select **STATUS: Survey...\Occupation Information Status**. Refer to "31.1 STATUS Functions" on how to access the STATUS menu.

OR

Press a hot key configured to access the screen **STATUS Occupation Information (Static)** or **STATUS Occupation Information (Moving)**. Refer to "6.1 Hot Keys" for information on hot keys.

OR

Press **USER**. Refer to "6.2 USER Key" for information on the **USER** key.

**STATUS
Occupation Information
(Static);
STATUS
Occupation Information
(Moving)**

Available for logging of raw observations.

The name of the screen changes with the static or moving mode of the receiver. The values are reset with each new static interval.

Information on this screen is available for **<R-Time Mode: None>** and **<R-Time Mode: Rover>**.

For static mode

Description of fields

Field	Description
<Obs Completed:>	The percentage of collected data required for successful processing. It is a conservative estimate based on a 10 - 15 km baseline. The criteria used to display this value depend on the settings for <Auto STOP:>, <STOP Criteria:> and <% Indicator:> in Main Menu: Config...\Point Occupation Settings .
<Time to Go:>	The estimated time in hours, minutes and seconds until the configured criteria for <STOP Criteria:> or <% Indicator:> is reached. The criteria used to display this value depend on the settings for <Auto STOP:>, <STOP Criteria:> and <% Indicator:> in Main Menu: Config...\Point Occupation Settings .
<Time at Point:>	The time passed since OCUPY (F1) was pressed in the SURVEY screen.
<Cycle Slips L1/L2:>	The number of cycle slips on L1 and L2 that have occurred since recording started on the current point.
<Obs Rec Rate:>	Rate at which raw observations are being recorded.
<Static Obs>	The number of logged static raw observations. Reset as soon as a new static interval starts.

For moving mode

Description of fields

Field	Description
<>5 Sats Since:>	The time for how long five or more satellites are tracked on L1 and L2 without interruption. The counter is reset if less than five satellites were tracked. The counter is not reset after OCUPY (F1) , STOP (F1) or STORE (F1) .
<GDOP:>	Current GDOP.
<Obs Rec Rate:>	Rate at which raw observations are being recorded.
<Moving Obs:>	The number of logged moving raw observations. Reset as soon a new moving interval starts.

Next step

CONT (F1) exits **STATUS Occupation Information (Static)** or **STATUS Occupation Information (Moving)**.

31.3

STATUS: Battery & Memory

Access

Select **STATUS: Battery & Memory**. Refer to "31.1 STATUS Functions" on how to access the STATUS menu.

OR

Press a hot key configured to access the screen **STATUS Battery & Memory**. Refer to "6.1 Hot Keys" for information on hot keys.

OR

Press **USER**. Refer to "6.2 USER Key" for information on the **USER** key.

OR

Tap the battery icon. Refer to the GPS1200 System Field Manual for information on icons.

OR

Tap the CompactFlash card/internal memory icon. Refer to the GPS1200 System Field Manual for information on icons.

STATUS Battery & Memory (Rover), Battery page



Battery A : 36%
Battery B : 100%

Battery Ext A: not attached
Backup Bat : OK



CONT (F1)

To exit **STATUS Battery & Memory (Rover)**.

REF (F5)

Available when the receiver is configured as real-time rover. To view battery and memory information for the reference.

PAGE (F6)

To change to another page on this screen.

Description of fields

Field	Description
Any field	The percentage of remaining power capacity for all batteries are displayed numerically. Batteries not in use are shown in grey.

Next step

PAGE (F6) changes to the **Memory** page. Refer to paragraph "STATUS Battery & Memory (Rover), Memory page".

STATUS Battery & Memory (Rover), Memory page

If no information for a field is available, for example no CompactFlash card is inserted, then ----- is displayed.

Device Used	CF Card
Size/Free (KB)	31954/15280
Mem CF Card	31954/15280
Mem Instrmnt	-----
Mem Programs	7624/7616
Mem System	908/831

CONT (F1)

To exit **STATUS Battery & Memory (Rover)**.

REF (F5)

Available when the receiver is configured as real-time rover. To view battery and memory information for the reference.

PAGE (F6)

To change to another page on this screen.

Description of fields

Field	Description
<Device Used:>	The memory device in use.
<Mem CF Card:>	The total/free memory for data storage on the CompactFlash card.
<Mem Instrmnt:>	The total/free memory for data storage on the internal memory. A grey field and grey dashes indicate an unavailable internal memory.
<Mem Programs:>	The total/free system memory used for application programs.
<Mem System:>	The total/free system memory. The system memory stores <ul style="list-style-type: none"> • receiver related files such as system settings. • survey related files such as codelists and configuration sets.

Next step

IF	THEN
the receiver is a real-time rover	REF (F5) shows battery and memory information for the real-time reference in use.
the receiver is not a real-time rover	CONT (F1) exits STATUS Battery & Memory (Rover) .

**STATUS
Battery & Memory
(Reference)**

This screen consists of the **Battery** and the **Memory** page. Both pages are similar to those of the rover screen. The information that is displayed depends on the real-time message.

Leica: Transfers precise values for all fields.
 RTCM: Transfer of any of the information not part of the message.
 CMR/CMR+: Transfers general status information such as O.K. and Low.

Next step

CONT (F1) returns to **STATUS Battery & Memory (Rover)**.

31.4

STATUS: System Information**Access**

Select **STATUS: System Information**. Refer to "31.1 STATUS Functions" on how to access the STATUS menu.

OR

Press a hot key configured to access the screen **STATUS System Information**. Refer to "6.1 Hot Keys" for information on hot keys.

OR

Press **USER**. Refer to "6.2 USER Key" for information on the **USER** key.

**STATUS
System Information,
Instrument page**

Shows the type of receiver, the serial number, the currently active system language, the serial number of the measurement engine, the availability of additional instrument hardware options such as event input and if the protected OWI commands have been activated by a licence key.

Next step

PAGE (F6) changes to the **Firmware** page. Refer to paragraph "STATUS System Information, Firmware page".

**STATUS
System Information,
Firmware page**

Shows the versions of all system firmware.

Description of fields

Field	Description
<Maintenance End:>	The expiry date of the software maintenance is shown.
<Meas Engine:>	The firmware version for the measurement engine.

Field	Description
<Meas Eng Boot:>	The firmware version of the boot software for the measurement engine.
<Boot:>	The firmware version boot software.
<LB2/OWI:>	The version of the LB2/OWI commands.
<Navigation:>	The navigation firmware version with the algorithms for the signal processing.
<API:>	The firmware version for the application program interface.
<EF Interface:>	The firmware version for the electric front interface.

Next step

PAGE (F6) changes to the **Application** page. Refer to paragraph "STATUS System Information, Application page".

Shows the versions of all uploaded application programs.

Next step

CONT (F1) exits **STATUS System Information**.

STATUS
System Information,
Application page

31.5

STATUS: Interfaces...

31.5.1

Real-Time Input

Description

This screen shows the incoming data from the real-time device. Refer to "31.2.2 Real-Time Status" paragraph "STATUS Real-Time, Device page" for information on the fields available, depending on the configured real-time device.

Access

This screen is accessible for a configured and activated real-time interface.

Select **STATUS: Interfaces...** Highlight **Real-Time. IFACE (F5)**. Refer to "31.1 STATUS Functions" on how to access the STATUS menu.

OR

Press a hot key configured to access the screen **STATUS Real-Time Input**. Refer to "6.1 Hot Keys" for information on hot keys.

OR

Press **USER**. Refer to "6.2 USER Key" for information on the **USER** key.

31.5.2

ASCII Input

Description

This screen shows the

- incoming ASCII data which is stored as a point annotation.
- description of the incoming ASCII data for each point annotation field.

Not used is shown for annotation fields which are not configured to receive incoming ASCII data.

Access

This screen is accessible for a configured and activated ASCII Input interface.

Select **STATUS: Interfaces....** Highlight **ASCII Input. IFACE (F5)**. Refer to "31.1 STATUS Functions" on how to access the STATUS menu.

OR

Press a hot key configured to access the screen **STATUS ASCII Input - XX**. Refer to "6.1 Hot Keys" for information on hot keys.

OR

Press **USER**. Refer to "6.2 USER Key" for information on the **USER** key.

STATUS

ASCII Input - XX

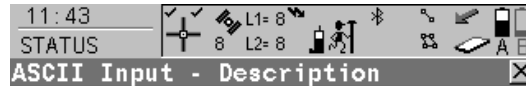

Next step

CONT (F1) exits **STATUS ASCII Input - XX**.

CONT (F1)

To exit **STATUS ASCII Input - XX**.

DATA (F3) and DESCR (F3)

To change between the given description for the incoming ASCII data or the last received ASCII data.

31.5.3

Tilt

Description

This screen shows the incoming data from the tilt device.

Access

This screen is accessible for a configured and activated tilt interface.

Select **STATUS: Interfaces....** Highlight **Tilt. IFACE (F5)**. Refer to "31.1 STATUS Functions" on how to access the STATUS menu.

OR

Press a hot key configured to access the screen **STATUS Tilt Measurement**. Refer to "6.1 Hot Keys" for information on hot keys.

OR

Press **USER**. Refer to "6.2 USER Key" for information on the **USER** key.



STATUS Tilt Measurement

This option is not available for RX1250 with SmartAntenna.

The units are independent from the settings in **CONFIGURE Units & Formats**. Displays the inclination in °.

Description of fields

Field	Description
<Data Time:>	The UTC or local time by when the last data was received.
<Temperature:>	The temperature as received from the tilt device.
<Incl-x:>	The x component, right/left, of the inclination as read from the tilt device.
<Incl-y:>	The y component, forwards/backwards, of the inclination as read from the tilt device.

Next step

CONT (F1) exits STATUS Tilt Measurement.

31.5.4

Meteo

Description

This screen shows the incoming data from the meteo device.

Access

This screen is accessible for a configured and activated meteo interface.

Select **STATUS: Interfaces....** Highlight **Meteo. IFACE (F5)**. Refer to "31.1 STATUS Functions" on how to access the STATUS menu.

OR

Press a hot key configured to access the screen **STATUS Meteo Measurement**. Refer to "6.1 Hot Keys" for information on hot keys.

OR

Press **USER**. Refer to "6.2 USER Key" for information on the **USER** key.



This option is not available for RX1250 with SmartAntenna.

STATUS Meteo Measurement

The units are independent from the settings in **CONFIGURE Units & Formats**. Displays the UTC or local time when the data was last received, the temperature in °C, the air pressure in hPa, the temperature in °C and the relative humidity in percentage.

Next step

CONT (F1) exits **STATUS Meteo Measurement**.

31.5.5**SmartAntenna****Description**

This screen shows

- the SmartAntenna connected.
- the seconds since the last data from the SmartAntenna was received.
- if the SmartAntenna is connected via Bluetooth or USB cable. This information is included in the name of the screen.

Access

This screen is accessible for a configured SmartAntenna interface.

Select **STATUS: Interfaces....** Highlight **SmartAntenna. IFACE (F5)**. Refer to "31.1 STATUS Functions" on how to access the STATUS menu.

**STATUS
SmartAntenna Interface
(XX)**

The way information is displayed indicates the configuration and connection status of the SmartAntenna.

Information displayed	SmartAntenna configured	SmartAntenna connected
in black	x	x
in grey	x	-
as -----	-	-

Next step

CONT (F1) exits **STATUS SmartAntenna Interface (XX)**.

31.5.6

Internet



This screen is not available for the GRX1200 Pro and GRX1200 GG Pro where Ethernet is used for the Internet connection.

Description

This screen shows

- if the receiver is online on the Internet.
 - for how long the receiver is online.
 - the technology of data transfer.
 - the amount of data received or sent since the receiver is online.
-

Access

This screen is accessible for a configured and activated Internet interface.

Select **STATUS: Interfaces...** Highlight **Internet. IFACE (F5)**. Refer to "31.1 STATUS Functions" on how to access the STATUS menu.

31.5.7**Event Input****Description**

This screen shows the incoming data from the event input interface.

Access

This screen is accessible for a configured and activated event input interface.

Select **STATUS: Interfaces....** Highlight **Event Input. IFACE (F5)**. Refer to "31.1 STATUS Functions" on how to access the STATUS menu.

OR

Press a hot key configured to access the screen **STATUS Event Input**. Refer to "6.1 Hot Keys" for information on hot keys.

OR

Press **USER**. Refer to "6.2 USER Key" for information on the **USER** key.

**STATUS
Event Input****Description of fields**

Field	Description
<Time:>	The local time of when the last event was available.
<Event Count:>	The incrementing number of detected events. Counting starts as soon as the event input is configured and activated. To reset the counter to 0, RESET (F5) .

Field	Description
<Event Pulse Count:>	<p>The incrementing number of detected pulses in the event input. Events which do not fulfil the requirements configured in CONFIGURE Event Input are counted as an event pulse but not as an event. This is, for example, the case when the time between two events is shorter than defined in <Time Guard:>.</p> <p>Counting starts as soon as the event input is configured and activated. To reset the counter to 0, RESET (F5).</p>

Next step
CONT (F1) exits **STATUS Event Input**.

Diagram

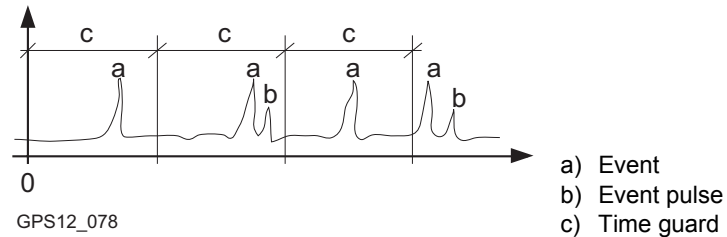

31.5.8

Remote Interfaces

Description

This screen shows all available ports and the interfaces and devices configured to these ports.

Access

This screen is accessible for a configured and activated remote interface.

Select **STATUS: Interfaces....** Highlight **Remote. IFACE (F5)**. Refer to "31.1 STATUS Functions" on how to access the STATUS menu.

OR

Press a hot key configured to access the screen **STATUS Remote Interfaces**. Refer to "6.1 Hot Keys" for information on hot keys.

OR

Press **USER**. Refer to "6.2 USER Key" for information on the **USER** key.

STATUS

Remote Interfaces

Port	Interface	Device
1	Real-Time	Satellite 3AS
2	Remote	-
3	Remote	-
RX	Remote	-
NET1	Remote	Ethernet
NET2	Remote	Ethernet
NET3	Remote	Ethernet

CONT (F1)

To exit **STATUS Remote Interfaces**.

DEVCE (F5)

Available for some devices. To view status information about the devices.

Description of fields

Column	Description
Port	The physical port on the instrument which is being used for the interface functionality.
Interface	The interface configured for the ports.
Device	The hardware connected to the chosen port.

Next step

CONT (F1) exits STATUS Remote Interfaces.

31.6

Bluetooth

Description

This screen shows

- Bluetooth ports available and configured.
- the device attached and connected to each Bluetooth port.
- the ID address of each device.

Access

Select **STATUS: Bluetooth**. Refer to "31.1 STATUS Functions" on how to access the STATUS menu.

OR

Tap the Bluetooth icon. Refer to the GPS1200 System Field Manual for information on icons.

STATUS Bluetooth

The way information is displayed indicates the configuration status of the Bluetooth port and the connection status of the device.

Information displayed	Bluetooth port configured	Device connected
in black	x	x
in grey	x	-
as -----	-	-

Next step

CONT (F1) exits **STATUS Bluetooth**.

32

MapView Interactive Display Feature

32.1

Overview

Description

MapView is an interactive display feature embedded in the firmware but used by all application programs as well as data management. MapView provides a graphical display of the survey elements which allows for a better overall understanding of how the data being used and measured relates to each other.

Depending on the application program and where in the application program MapView is accessed from, different modes, and their associated functionality, are available.

The displayed data in all modes of MapView can be shifted by using both the arrow keys and the touchscreen.

MapView modes

MapView is available in three modes:

Map mode:

- Part of data management.
- Is also available within some application programs, for example, the Reference Line application program.
- Can be used to view, select and edit points, lines and areas.
- Available as the **Map** page in data management and some application programs.

Plot mode:

- Is available to view results in various application programs. For example, COGO application program.
- Available as the **Plot** page in some application programs.

Survey mode:

- Part of the Survey application program.
- Is available within some application programs, for example, Stakeout application program.

- Can be used to select lines and areas.
- Same as Map mode but also shows the positions of the reference stations and the rover.
- Provides special functionality when staking out points.
- Available as the **Map** page in Survey and some application programs.

Modes within application programs

It is possible to access different MapView modes from the same application program. For example, **REFLINE Choose Task & Reference Line, Map** page accesses MapView in map mode, whereas, **REFLINE XX Stakeout, Map** page accesses MapView in survey mode.

Displayable data

The data displayed in MapView is defined by the application program through which it was accessed, filters set in **MANAGE Sorts & Filters**, and the selections made in **XX MapView Configuration**.

32.2

Accessing MapView

Description

The MapView interactive display feature is provided as a page within all application programs and data management. It is accessed through the application program itself. Depending on the application program and from where in the application program MapView is accessed, different MapView modes are available.

Access step-by-step

Example access for map mode:

Step	Description
1.	Select Main Menu: Manage...Data . OR Press a hot key configured to access the screen MANAGE Data: Job Name . Refer to "6.1 Hot Keys" for information on hot keys. OR Press USER . Refer to "6.2 USER Key" for information on the USER key. OR From a choicelist in some screens for example in application programs.
2.	PAGE (F6) until MANAGE Data: Job Name, Map page is active.

Example access for plot mode:

Step	Description
1.	Press PROG . Highlight COGO. CONT (F1) . Refer to "36.2 Accessing the Application Programs Menu" for information on the PROG key.

Step	Description
	<p>OR</p> <p>Press a hot key configured to access the screen COGO COGO Begin. Refer to "6.1 Hot Keys" for information on hot keys.</p> <p>OR</p> <p>Press USER. Refer to "6.2 USER Key" for information on the USER key.</p>
2.	CONT (F1) to access COGO COGO Menu .
3.	COGO COGO Menu Highlight Intersections .
4.	CONT (F1) to access COGO Intersection Input .
5.	COGO Intersection Input Choose a method and enter appropriate data.
6.	CALC (F1) to access COGO XX Results .
7.	PAGE (F6) until COGO XX Results, Plot page is active.

Example access for survey mode:

Step	Description
1.	<p>Select Main Menu: Survey.</p> <p>OR</p> <p>Press a hot key configured to access the screen SURVEY Survey Begin. Refer to "6.1 Hot Keys" for information on hot keys.</p>

Step	Description
	OR Press USER . Refer to "6.2 USER Key" for information on the USER key. OR Press PROG . Highlight Survey. CONT (F1) . Refer to "36.2 Accessing the Application Programs Menu" for information on the PROG key.
2.	CONT (F1) to access SURVEY Survey: Job Name .
3.	PAGE (F6) until SURVEY Survey: Job Name, Map page is active.



MapView can be open multiple times, for example as **SURVEY Survey: Job Name, Map** page accessed from **GPS1200 Main Menu** and as **MANAGE Data: Job Name, Map** page accessed using the **USER** key.

32.3

Configuring MapView

Description

Allows options to be set which are used as default options within MapView. These settings are stored within the configuration set and apply to all **Map** and **Plot** pages, regardless of how MapView is accessed.



Any changes made in **XX MapView Configuration** affect the appearance of MapView in all application programs, not just the active application program.

Access step-by-step

Step	Description
1.	Refer to "32.2 Accessing MapView" to access MapView in map, plot or survey mode.
2.	SHIFT CONF (F2) to access XX MapView Configuration .

XX MapView Configuration, Points page

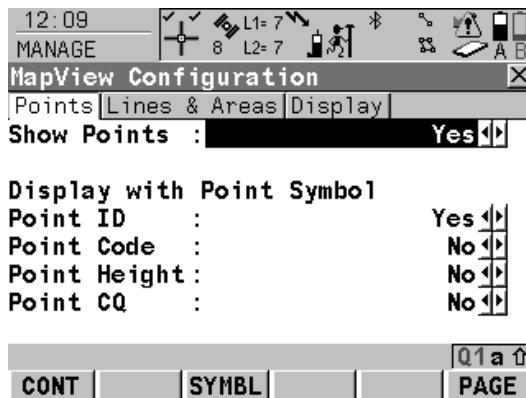

CONT (F1)

To confirm the selections and to return to the screen from where this screen was accessed.

SYMBL (F3)

To view all point symbols and their descriptions.

PAGE (F6)

To change to another page on this screen.

Description of fields

Field	Option	Description
<Show Points:>	Yes or No	Determines if points are displayed in MapView.
<Point ID:>	Yes or No	Available for <Show Points: Yes>. Determines if the ID of a point is displayed.
<Point Code:>	Yes or No	Available for <Show Points: Yes>. Determines if the code of a point is displayed.
<Point Height:>	Yes or No	Available for <Show Points: Yes>. Determines if the height of a point is displayed.
<Point CQ:>	Yes or No	Available for <Show Points: Yes>. Determines if the coordinate quality of a point is displayed.

Displayable point information

200
 ▲ Tree
 435.000
 0.000

- a) <Point ID:>
- b) <Point Code:>
- c) <Point Height:>
- d) <Point CQ:>

Next step

PAGE (F6) changes to the **Lines&Areas** page. Refer to paragraph "XX MapView Configuration, Lines&Areas page".

XX
MapView Configuration,
Lines&Areas page

Description of fields

Field	Option	Description
<Show Lines:>	Yes or No	Determines if lines are displayed in MapView.
<Show Line ID:>	Yes or No	Available for <Show Lines: Yes>. Determines if the ID of a line is displayed.
<Show Line Code:>	Yes or No	Available for <Show Lines: Yes>. Determines if the code of a line is displayed.
<Show Areas:>	Yes or No	Determines if areas are displayed in MapView.
<Show Area ID:>	Yes or No	Available for <Show Areas: Yes>. Determines if the ID of an area is displayed.
<Show Area Code:>	Yes or No	Available for <Show Areas: Yes>. Determines if the code of an area is displayed.

Displayable line/area information

A line is shown as example.

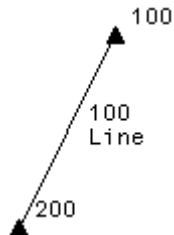

- a) <Show Line ID:>
- b) <Show Line Code:>

Next step

PAGE (F6) changes to the **Display** page. Refer to paragraph "XX MapView Configuration, Display page".

**XX
MapView Configuration,
Display page**

Description of fields

Field	Option	Description
<Show Pt Info:>	When <200 Pts or As Configured	Determines if point information is shown or not. For <Show Pt Info: When <200 Pts> point information is not shown when more than 200 points are displayed. For <Show Pt Info: As Configured> the point information, as configured in XX MapView Configuration, Points page, is shown regardless of the number of points being displayed.
<Datum View:>	WGS 1984 or Local	Determines the datum in which the points are viewed.  When both GPS and TPS data is being used, it is possible that some data will not be displayed.
<Rotate 180°:>	Yes or No	Available for <Datum View: Local>. To rotate the map by 180°. The north arrow is not rotated and still orientated towards the top of the screen.
<Toolbar:>	Yes or No	Determines if the toolbar of touch icons are displayed. Refer to "32.4.3 Toolbar".
<Curr Pos Info:>	<None>	Determines if a certain information related to the current position is displayed in the lower left corner of the map (only visible in survey mode). No information is displayed in the map.

Field	Option	Description
	Point ID	Point ID of the current position.
	Code	Code of the current position.
	Attrib 01	User defined attribute.
	Attrib 02	User defined attribute.
	Attrib 03	User defined attribute.
	Attrib 04	User defined attribute.
	Attrib 05	User defined attribute.
	Quality 3D	Current 3D coordinate quality of the computed position.
<Show Path:>	Yes or No	Displays the path of the rover as a dashed line.

Next step

CONT (F1) confirms the selections and returns to where **XX MapView Configuration** was accessed.

32.4 MapView Components



32.4.1 Softkeys

Description

Standard functionality is provided by a number of softkeys within MapView. These softkeys are available regardless of the mode in which MapView was accessed and always perform the same functions.

Standard softkeys

The softkeys described below are standard on all MapView screens. For descriptions of mode specific softkeys see appropriate chapters.

Softkey	Description
ZOOM+ (F4)	To zoom into the map.  Pressing ESC stops the zooming process. All keys become active again.
ZOOM- (F5)	To zoom out of the map.  Pressing ESC stops the zooming process. All keys become active again.
PAGE (F6)	To change to another page on this screen.
SHIFT CONF (F2)	To configure MapView. Accesses XX MapView Configuration . Refer to "32.3 Configuring MapView".
SHIFT FIT (F3)	To fit all displayable data into the screen area. Refer to "32.4.3 Toolbar" for more information.

Touch screen functions

Some softkey functionality can be replaced by touch screen functions.

Softkey	Touch equivalent
PAGE (F6)	Tap on a page tab.
SHIFT FIT (F3)	Tap on fit touch icon. Refer to "32.4.3 Toolbar"

32.4.2

Screen Area

Description

The MapView screen area is very similar in all cases. The positions of the scale bar, the North arrow and the toolbar, if visible, do not change.

Standard screen

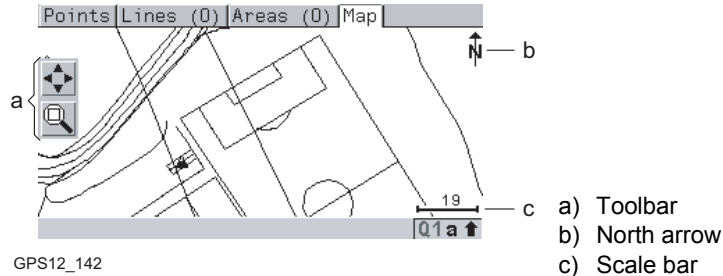

Scale bar

Symbol	Description
	Scale of the current screen. The minimum is 0.5 m. There is no maximum for the zoom but the scale cannot display values greater than 99000 m. In this case the value displayed will be >99000 m.

North arrow

Symbol	Description
	North arrow. North is always orientated towards the top of the screen.



Toolbar

Symbol	Description
	Touch icon toolbar. Refer to "32.4.3 Toolbar" for more information about the functionality of the touch icons in the toolbar.

Point with focus

Symbol	Description
	The point that has the focus.

Rover

Symbol	Description
	Available in survey mode. Position of the rover.  The rover path is shown as dashed line.



32.4.3

Toolbar

Description

Touch icons are available in a toolbar, if **<Toolbar: Yes>** in **XX MapView Configuration, Display** page. The toolbar is always located on the left hand side of the screen. Some of the functions performed by the touch icons can also be replicated using a softkey in the same mode as when the touch icon appears. The softkey equivalent to each touch icon, if one exists, are indicated below.

Touch icons in the toolbar

Touch icon	Softkey	Description
	SHIFT FIT (F3)	Available as a touch icon in map mode. The fit touch icon fits all displayable data, according to filters and the map configuration, into the screen area, using the largest possible scale.
	-	The windowing touch icon zooms to a specified area window. An area window can be drawn by tapping on the top left and the bottom right corner of the area. This causes the screen to zoom to the selected area.

32.4.4

Point Symbols

Points

When **<Show Points: Yes>** in **XX MapView Configuration**, points are displayed, in all modes, according to their class.

Symbol	Description
▲	3D control point is a point of class CTRL with full coordinate triplet.
▲	2D control point is a position only point of class CTRL .
⊗	Adjusted point is a point of class ADJ .
▽	Reference point is a point of class REF .
⊗	Average point is a point of class AVGE .
⊙	Measured point is a point of class MEAS .
⊗	Single Point Position uploaded from LGO.
□	Navigated point is a point of class NAV .
+	Estimated point is a point of class EST .
⊕	Calculated COGO point is a point of class MEAS or CTRL depending on the COGO calculation method.



Points of class **NONE** or points of class **CTRL/MEAS** with a height only component cannot be displayed in MapView.



A list of the point types available, and their description, is available by pressing **SYMBL (F3)** in **XX MapView Configuration, Points** page. Refer to "32.3 Configuring MapView".

32.5

Map Mode

32.5.1

MapView in Map Mode

Description

The map mode of MapView is available as the **Map** page in data management and some application programs. It can be used to display, select and edit points, lines and areas.

Access

Refer to "32.2 Accessing MapView" paragraph "Example access for map mode:".

OR

From a choicelist in some screens, for example, in application programs, which access data management.

OR

As a part of an application program, for example, COGO.



The **MANAGE Data: Job Name, Map** page is used as the example below. The functions described are the same for all **Map** pages in map mode.

**MANAGE
Data: Job Name,
Map page**

The softkeys described below are specific to MapView in map mode. Refer to "32.4.1 Softkeys" for descriptions of the standard softkeys.

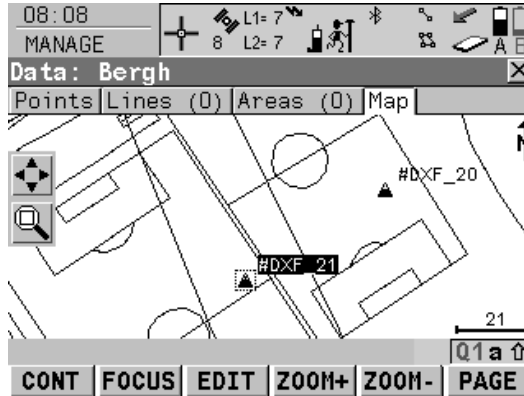

FOCUS (F2) or DONE (F2)

To activate the focus tool and select a point without using the touch screen. Refer to "32.5.2 Selecting Points, Lines and Areas".

EDIT (F3)

To edit the highlighted point's parameters. Accesses **MANAGE Edit Point: Point ID**.

SHIFT CENTR (F4)

To centre the screen around the point with the current focus, or the focus tool if **DONE (F2)** is visible.

SHIFT FILTR (F5)

Available for **FOCUS (F2)**. To change the filter settings. Accesses **MANAGE Sorts & Filters**.

Touch screen functions

Key	Touch equivalent
FOCUS (F2)	Tap on a point.

32.5.2





Selecting Points, Lines and Areas

Description

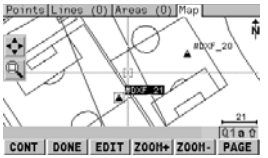
Selecting a point, line or area in the map mode of MapView is possible using both the softkeys and the touch screen. The functionality of all screens and field are similar for the selecting of a point, line or area. The step-by-step instructions for selecting a point using the softkeys can be applied for lines and areas.

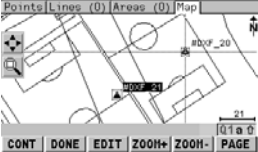
Select a point using the softkeys step-by-step

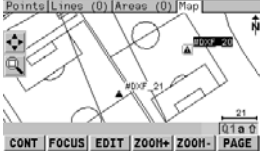

Step	Description	Display
1.	Refer to "32.5.1 MapView in Map Mode" to access MANAGE Data: Job Name, Map page.	
	If no point field is highlighted on the previous page when the Map page is accessed, then any point that is selected will be assigned to the first point field on the previous page, the second point to the second point field, etc. If a point field is highlighted when the Map page is accessed then the point selected will be assigned to that field.	
2.	FOCUS (F2) to activate the focus tool. The focus tool is made up of a square placed at the centre of dashed cross-hairs. The focus tool always starts at the centre of the screen area.	

Step	Description	Display
3.	Use the arrow keys to navigate the focus tool to the point to select. A point is available for selection when the square is centred around the point symbol.	
4.	Press ENTER to select the point. The point parameter text, as defined in XX MapView Configuration, Points page, is highlighted.	
	When there are multiple points within the same area and the precise selection is unclear, pressing ENTER will access XX Select Point .	
5.	Have multiple points been selected? <ul style="list-style-type: none"> • If yes, continue with step 6. • If no, continue with step 8. 	
6.	XX Select Point Point ID The ID of the points within range of the point selection. Point Code The code of the points within range of the point selection. Select the desired point.	
	MORE (F5) to display information about the point code, the 3D coordinate quality and class, the time the point was stored and the date the point was stored.	

Step	Description	Display
7.	CONT (F1) returns to MANAGE Data: Job Name, Map page with the focus on the selected point.	
8.	DONE (F2) exits the focus tool.	

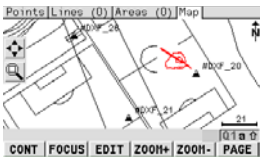
Selecting a point using the touch screen step-by-step

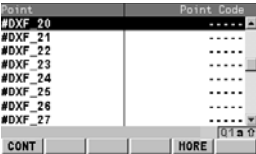
Step	Description	Display
1.	Refer to "32.5.1 MapView in Map Mode" to access MANAGE Data: Job Name, Map page.	
	If no point field is highlighted on the previous page when the Map page is accessed, then any point that is selected will be assigned to the first point field on the previous page, the second point to the second point field, etc. If a point field is highlighted when the Map page is accessed then the point selected will be assigned to that field.	
2.	Tap on the point to be selected.	

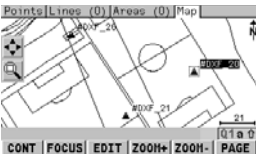
Step	Description	Display
	When there are multiple points within the same area and the precise selection is unclear, tapping on the point will access XX Select Point .	
3.	Have multiple points been selected? <ul style="list-style-type: none"> • If yes, continue with step 4. • If no, continue with step 6. 	
4.	XX Select Point Point ID The ID of the points within range of the point selection. Point Code The code of the points within range of the point selection. Select the desired point.	
	MORE (F5) to display information about the point code, the 3D coordinate quality and class, the time the point was stored and the date the point was stored.	
5.	CONT (F1) returns to MANAGE Data: Job Name, Map page with the focus on the selected point.	
6.	A square is centred on the selected point and the point parameter text, as defined in XX MapView Configuration, Points page, is highlighted.	

32.6 Plot Mode - MapView Screen Area

Description

The plot mode of MapView is available as the **Plot** page in an application program and can be used to view the results of the application program. Results are shown in black, all other information, that is displayable, is shown in grey.

Access

Refer to "32.2 Accessing MapView" paragraph "Example access for plot mode:".
OR

As a part of an application program, for example, COGO.



The **COGO XX Results, Plot** page is used as the example below. The functions described are the same for all **Plot** pages.

COGO XX Results, Plot page

The softkeys described below are specific to MapView in plot mode. Refer to "32.4.1 Softkeys" for descriptions of the standard softkeys.

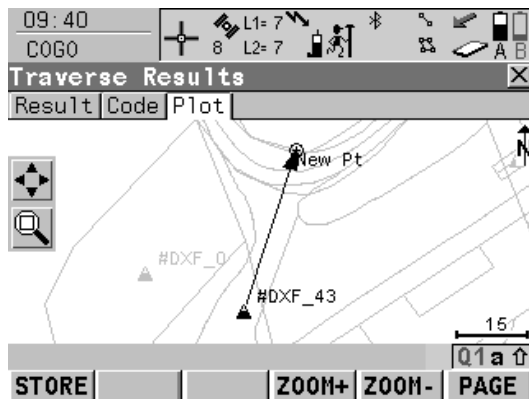

SHIFT FACE (F1) and SHIFT PLAN (F1)
Available in **REFPLANE XX Reference Plane, Plot** page. To change between the face and the plane view of the plane.

SHIFT FIT R (F4)
To fit the results in the screen area.

SHIFT RFRSH (F5)
To refresh the screen.

Touch screen functions

Key	Touch Equivalent
SHIFT FIT R (F4)	Tap on fit results touch icon. Refer to "32.4.3 Toolbar"

Example of results displayed in MapView on Plot page

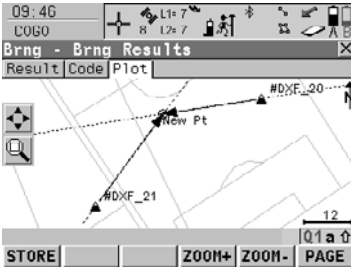
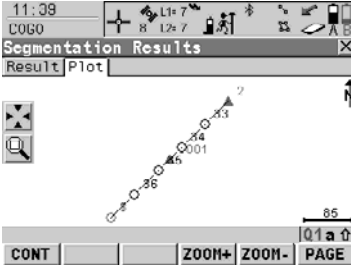
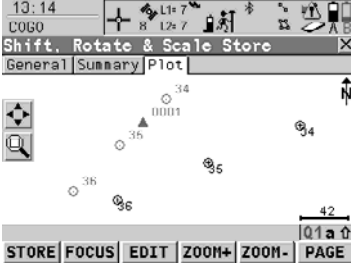
Application	Display	Description
<p>COGO Intersection, Bearing - Bearing</p>		<p>Intersecting lines with known bearings from known points</p>
<p>COGO line calculation, Segmentation</p>		<p>Points defining the line and those created on the line</p>
<p>COGO Shift, Rotate & Scale</p>		<p>Original points in grey, calculated COGO points in black</p>

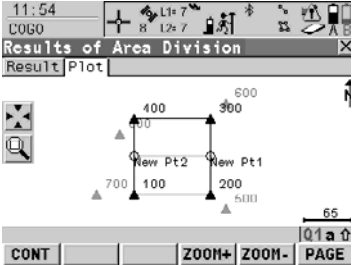
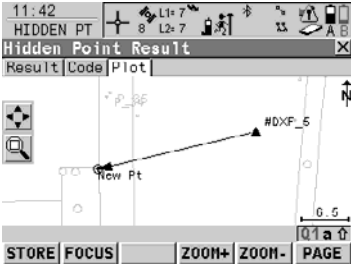
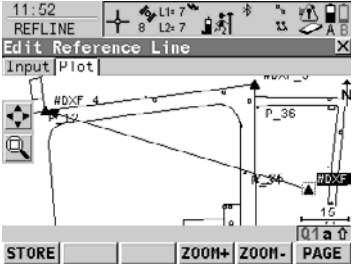
Application	Display	Description
COGO Area Division	 <p>The screenshot shows a software interface for 'COGO Area Division'. At the top, the time is 11:54. The title bar reads 'Results of Area Division'. Below the title bar, there is a menu bar with 'Result Plot'. The main display area shows a plot with several points and lines. Two points are labeled 'New Pt2' and 'New Pt1'. Dimensions are shown: 400, 300, 600, 700, 100, and 200. A scale bar at the bottom right indicates 65 units. The bottom control bar includes 'CONT', 'ZOOM+', 'ZOOM-', and 'PAGE' buttons.</p>	Points from the area and the area division are black, other points are grey
Hidden Point, Bearing and Distance	 <p>The screenshot shows a software interface for 'Hidden Point Result'. At the top, the time is 11:42. The title bar reads 'Hidden Point Result'. Below the title bar, there is a menu bar with 'Result Code Plot'. The main display area shows a plot with a point labeled 'New Pt' and a line extending to a point labeled '#DXF_5'. A scale bar at the bottom right indicates 6.5 units. The bottom control bar includes 'STORE', 'FOCUS', 'ZOOM+', 'ZOOM-', and 'PAGE' buttons.</p>	Line between known point and hidden point
Reference Line, Edit Reference Line	 <p>The screenshot shows a software interface for 'Edit Reference Line'. At the top, the time is 11:52. The title bar reads 'Edit Reference Line'. Below the title bar, there is a menu bar with 'Input Plot'. The main display area shows a plot with several points and lines. Points are labeled '#DXF_4', 'P_36', and '#DXF_5'. A scale bar at the bottom right indicates 15 units. The bottom control bar includes 'STORE', 'ZOOM+', 'ZOOM-', and 'PAGE' buttons.</p>	Reference line or arc with target point as offset from reference line

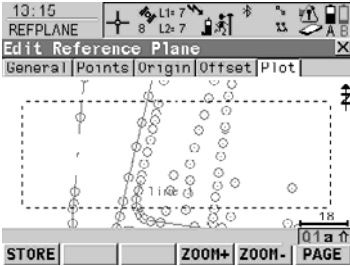
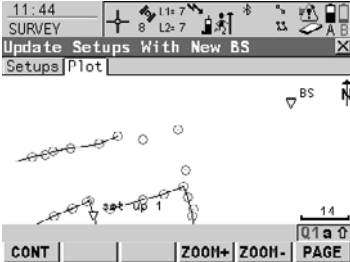
Application	Display	Description
Reference Plane, Edit Reference Plane		<p>A dashed rectangle indicates the face view of the plane.</p>
Update Setups		<p>Points from the job in grey, setup points and updated backsight points in black</p>

32.7

32.7.1

Survey Mode

MapView in Survey Mode

Description

The survey mode of MapView is available as the **Map** page in Survey and is used to display the positions of the reference station and the rover during a survey. It can also be used to select lines and areas. It is also used by the Stakeout, Reference Line and Reference Plane application programs to assist in the staking out/measuring of points.

Refer to "32.7.2 MapView in Staking Out Survey Mode" for more information about using MapView when staking out points.

Access

Refer to "32.2 Accessing MapView" paragraph "Example access for survey mode:".



The **SURVEY Survey: Job Name, Map** page is used as the example below. The functions described are the same for all **Map** pages in survey mode.

SURVEY Survey: Job Name, Map page

The softkeys described below are specific to MapView in survey mode. Refer to "32.4.1 Softkeys" for descriptions of the standard softkeys.

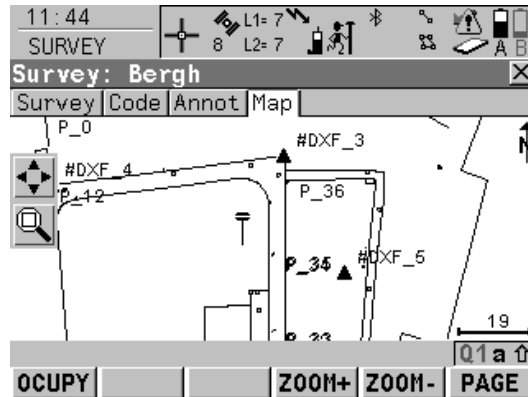

SHIFT FACE (F1) and SHIFT PLAN (F1)
 Available in **REFPLANE Measure Point on Plane, Map** page. To change between the face and the plane view of the plane.

SHIFT CENTR (F4)
 To centre the screen around the point with the current focus or the focus tool, if **FOCUS (F2)** is active.

SHIFT RFRSH (F5)
 To refresh the screen.

Touch screen functions

Key	Touch equivalent
SHIFT FIT (F3)	Tap on fit touch icon. Refer to "32.4.3 Toolbar".

32.7.2

MapView in Staking Out Survey Mode

Description

When staking out a point in the Stakeout or Reference Line application programs, the **Map** page is available. The MapView survey mode is provided for this operation, with some differences.

- In the Stakeout application program, active points can be selected using the touch screen, as points to be staked.
 - An arrow indicating the direction from the current position to the point to be staked is provided.
 - A box provides information such as the distance to the stakeout point and the CUT/FILL value so the point to be staked can be found.
-

Data displayed

For Stakeout application program.

- From **<Job:>**, all points and displayable lines and areas are shown in grey.
- From **<Stakeout Job:>**, all points, according to filter settings, are displayed in black; lines and areas are not displayed.

For Reference Line application program.

- From **<Control Job:>**, all points and displayable lines and areas are shown in grey.
 - The point to be staked is displayed in black.
 - The reference line/arc is displayed in black.
-

The **STAKEOUT XX Stakeout, Map** page is used as the example below. The functions described are the same for all **Map** pages available when staking out.



Access step-by-step

Example access for MapView in survey mode, Stakeout

Step	Description
1.	<p>Select Main Menu: Programs...\Stakeout.</p> <p>OR</p> <p>Press PROG. Highlight Stakeout. CONT (F1). Refer to "36.2 Accessing the Application Programs Menu" for information on the PROG key.</p> <p>OR</p> <p>Press a hot key configured to access the screen STAKEOUT Stakeout Begin. Refer to "6.1 Hot Keys" for information on hot keys.</p> <p>OR</p> <p>Press USER. Refer to "6.2 USER Key" for information on the USER key.</p> <p>OR</p> <p>Press STAKE (F5) from another application program, for example COGO.</p>
2.	CONT (F1) to access STAKEOUT XX Stakeout .
3.	PAGE (F6) until STAKEOUT XX Stakeout, Map page is active.

**STAKEOUT
XX Stakeout,
Map page**

The softkeys described below are specific to MapView in survey mode, staking out. Refer to "32.4.1 Softkeys" for descriptions of the standard softkeys.

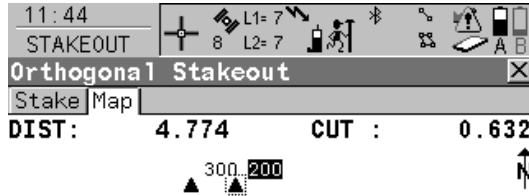

SHIFT CENTR (F4)

To centre the screen around the rover.

Description of fields

Field	Option	Description
<DIST:>	Output	Horizontal distance from the current position to the point to be staked.
<CUT:>	Output	The negative height difference from the height of the current position to the height of the point to be staked.
<FILL:>	Output	The positive height difference from the height of the current position to the height of the point to be staked.

32.7.3

Selecting Lines and Areas

Description

Selecting a line or area in the survey mode of MapView is possible using the touch screen. The functionality of all screens and field are similar for the selecting of a line or area. The step-by-step instructions for selecting a line using the touchscreen can be applied for areas.

Selecting a line step-by-step

Step	Description
1.	<p>Select Main Menu: Survey.</p> <p>OR</p> <p>Select Main Menu: Programs...\Survey.</p> <p>OR</p> <p>Press a hot key configured to access the screen SURVEY Survey Begin. Refer to "6.1 Hot Keys" for information on hot keys.</p> <p>OR</p> <p>Press USER. Refer to "6.2 USER Key" for information on the USER key.</p> <p>OR</p> <p>Press PROG. Highlight Survey. CONT (F1). Refer to "36.2 Accessing the Application Programs Menu" for information on the PROG key.</p>
2.	PAGE (F6) until SURVEY XX Survey, Map page is active.
3.	<p>Tap on the line to be selected.</p> <p> When there are multiple lines within the same area and the precise selection is unclear, tapping on the line will access XX Select Line.</p>
4.	Have multiple lines been selected ?

Step	Description
	<ul style="list-style-type: none"> • If yes, continue with step 5. • If no, continue with step 7.
5.	<p>XX Select Line</p> <p>Point ID The ID of the lines within range of the line selection.</p> <p>Point Code The code of the lines within range of the point selection.</p> <p>Select the desired line.</p>
	<p>MORE (F5) to display information about the line code, the start time, the end time, the length and the Open status of the line.</p>
6.	<p>CONT (F1) returns to SURVEY Data: Job Name, Map page.</p>
7.	<p>A message appears in the message line.</p> <ul style="list-style-type: none"> • Line Line Name was opened (If the line was close before). • Line Line Name was closed (If the line was open before).

33**Update Setups****33.1****Terminology****Description**

This chapter describes technical terms related to Setup.

Setup

Setup is an application program on TPS1200 instruments. It can be used to orientate the TPS1200 instrument.

Backsight

In a TPS survey, the instrument is set up over a point.

A reading onto a fixed point of reference, usually a benchmark of some sort, is taken in order to orientate the instrument. This reading is called backsight.

Since a survey progresses from a point of known position to points of unknown position, a backsight is a reading looking backward along the line of progress.

Unknown backsight point

A point with unknown coordinates used as backsight point is called unknown backsight point.

It may happen that at the time of a set up, the coordinates of the backsight point are not known yet. The survey starts with wrong angles. The coordinates of the backsight point are determined later by a COGO calculation, for example, or by GPS.

If the coordinates of the unknown backsight point are determined, the setup using this backsight has to be updated in order to correct the angles. Additionally, the coordinates of all TPS measurements related to this setup must be recalculated.

Relevance for GPS

An unknown backsight point can be used to set up a TPS1200 instrument. After finishing the TPS job, the coordinates of the unknown backsight point can be determined using GPS1200 with the CompactFlash from the TPS1200 instrument. When assigning the same point ID of the unknown backsight point to a point measured with GPS1200, the TPS setup and all related calculations can be updated on GPS1200.

33.2

Procedure of Updating Setups

Access

XX CONFIRMATION: 1100 is automatically accessed when

a TPS1200 setup with an unknown backsight point exists on the CompactFlash card in a GPS1200 receiver

AND

the same point ID of the unknown backsight point is assigned to a point measured with GPS1200.

XX

CONFIRMATION: 1100

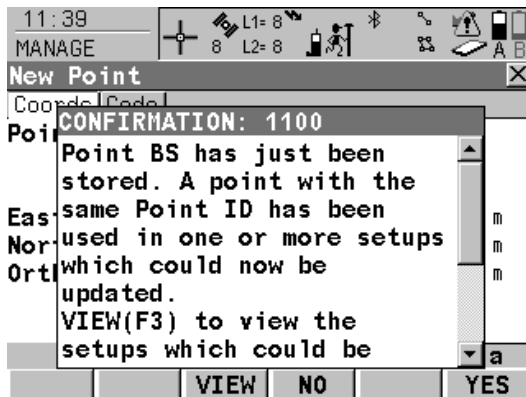

VIEW (F3)

To view all setups from TPS1200 using the unknown backsight point whose point ID has been assigned to a point measured with GPS1200.

NO (F4)

To return to the screen from where this screen was accessed without updating any setup from TPS1200 using the unknown backsight point.

YES (F6)

To update all setups from TPS1200 using the unknown backsight point and to return to the screen from where this screen was accessed.

Next step

VIEW (F3) views all setups using the unknown backsight and accesses **GPS1200 Update Setups with new BS**. Refer to paragraph "GPS1200 Update Setups with new BS, Setups page".

GPS1200
Update Setups with new
BS,
Setups page



CONT (F1)

To return to **XX CONFIRMATION: 1100**.

MORE (F5)

To change between time and date of when the setup was stored.

PAGE (F6)

To change to another page on this screen.

Description of columns

Column	Description
Setup	The identifier for the setup from TPS1200 using the unknown backsight point whose point ID has been assigned to a point measured with GPS1200
Date	The date the setup was stored. The format is as defined in CONFIGURE Units & Formats, Time page.
Time	The time the setup was stored.

Next step

PAGE (F6) accesses **Update Setups with new BS, Plot** page. Refer to paragraph "GPS1200 Update Setups with new BS, Plot page".

GPS1200
Update Setups with new
BS,
Plot page

The functionality and softkeys available are described in the MapView chapter. Refer to "32.6 Plot Mode - MapView Screen Area".

Points from the job are displayed in grey, setup points and updated backsight points are displayed in black.

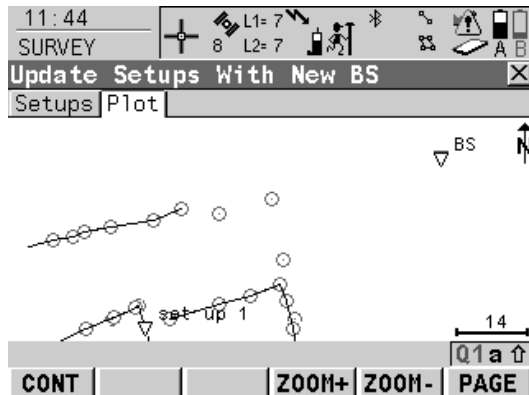

CONT (F1)

To update the all setups.

PAGE (F6)

To change to another page on this screen.

Next step

CONT (F1) returns to **XX CONFIRMATION: 1100** where either all or no setups can be updated.

34**NTRIP via Internet****34.1****Overview****Description**

Networked Transport of **RTCM** via **Internet Protocol**

- is a protocol streaming real-time corrections over the Internet.
- is a generic protocol based on the Hypertext Transfer Protocol HTTP/1.1.
- is used to send differential correction data or other kinds of streaming data to stationary or mobile users over the Internet, allowing simultaneous PC, laptop, PDA, or receiver connections to a broadcasting host.
- supports wireless Internet access through mobile IP networks like digital cellular phones or modems.

System components

NTRIP consists of three system components:

- NTRIP Clients
- NTRIP Servers
- NTRIP Caster

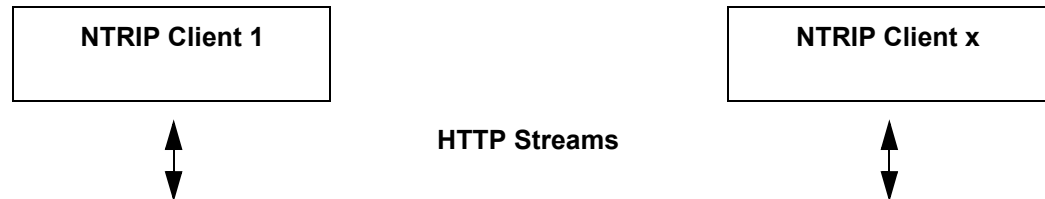

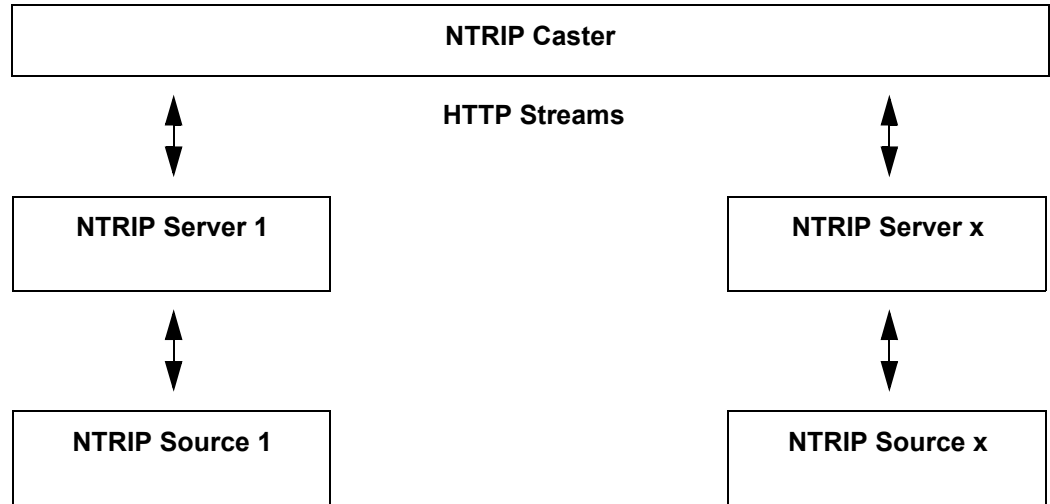

NTRIP Client

The NTRIP Client receives data streams. This could be, for example a real-time rover receiving real-time corrections.

In order to receive real-time corrections, the NTRIP Client must first send

- a user ID
- a password
- an identification name, the so-called MountPoint, from which real-time corrections are to be received

to the NTRIP Caster.

NTRIP Server

The NTRIP Server transfers data streams.

In order to send real-time corrections, the NTRIP Server must first send

- a password
- an identification name, the so-called MountPoint, where the real-time corrections come from

to the NTRIP Caster.

Before sending real-time corrections to the NTRIP Caster for the first time, a registration form must be completed. This is available from the NTRIP Caster administration centre. Refer to the Internet.

NTRIP Source

The NTRIP Source generates data streams. This could be, for example a GRX1200 Pro or GRX1200 GG Pro configured as reference sending out real-time corrections.

NTRIP Caster

The NTRIP Caster

- is an Internet server handling various data streams to and from the NTRIP Servers and NTRIP Clients.
- checks the requests from NTRIP Clients and NTRIP Servers to see if they are registered to receive or provide real-time corrections.
- decides whether there is streaming data to be sent or to be received.



The NTRIP Server could be the GRX1200 Classic receiver itself. This means the GPS1200 receiver is both the NTRIP Source generating the real-time data and also the NTRIP Server transferring this data to the NTRIP Caster.

Graphic

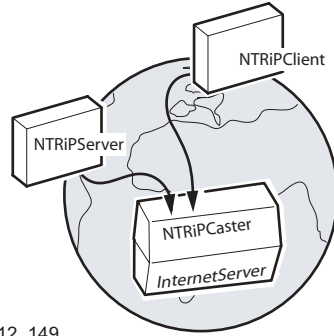

GPS12_149

NTRIP and it's role in the Internet

34.2

Configuring a Real-Time Rover for Using NTRIP Service

34.2.1

Configuring an Access to the Internet

Requirements

- Firmware v1.5 or higher must be loaded on the GPS1200 receiver.
- Firmware v1.42 or higher must be loaded on the RX1200.





To access to the Internet with a GPS1200 receiver, **General Packed Radio System** devices will normally be used. GPRS is a telecommunication standard for transmitting data packages using the Internet Protocol (IP).



A GPRS device can be connected in a clip-on-housing or with RX1250 via Bluetooth.

Configure access to Internet step-by-step

The following table explains the most common settings. Refer to the stated chapter for more information on screens.

Step	Description	Refer to chapter
1.	Refer to "22.2 Accessing Configuration Interfaces" to access CONFIGURE Interfaces .	
2.	In CONFIGURE Interfaces highlight Internet .	
3.	EDIT (F3) to access CONFIGURE Internet Interface .	
4.	CONFIGURE Internet Interface <Internet: Yes:> <IP Address: Dynamic>	22.11

Step	Description	Refer to chapter
	<p><User ID:> Some providers ask for a user ID to allow connecting to the Internet via GPRS. Contact your provider if a user ID needs to be used.</p> <p><Password:> Some providers ask for a password to allow connecting to the Internet via GPRS. Contact your provider if a password needs to be used.</p>	
5.	DEVCE (F5) to access CONFIGURE GPRS Internet Device.	
6.	<p>CONFIGURE GPRS Internet Devices Highlight the GPRS / Internet device to be used.</p>	
	NEW (F2) to create a new GPRS / Internet device.	23.3
	SRCH (F4) Available on RX1250 with <Port: Bluetooth x> and a Bluetooth device being selected. To search for all available Bluetooth devices. If more than one Bluetooth device is found a list of available devices is provided.	
7.	CONT (F1) to return to CONFIGURE Internet Interface.	
8.	CONT (F1) to return to CONFIGURE Interfaces.	
9.	CTRL (F4) to access CONFIGURE GPRS/Internet Connection.	
10.	<p>CONFIGURE GPRS/Internet Connection <APN:> Available for some devices. The Access Point Name of a server from the network provider, which allows access to data services. Contact your provider to get the correct APN. Mandatory for using GPRS.</p>	24.7

Step	Description	Refer to chapter
	CODES (F3) Available for digital cellular phones of GSM technology. To enter the Personal Identification Number of the SIM card. If the PIN is locked for any reason, for example the wrong PIN was entered, input the Personal UnbloCking code for access to the PIN.	
11.	CONT (F1) to return to GPS1200 Main Menu .	
	The receiver is now online to the Internet. The Internet online status icon is displayed. But because GPRS is being used, no charges are yet made since no data transfer from the Internet has yet taken place.	
12.	USER	
13.	STAT (F3) to access STATUS Status Menu .	
14.	Highlight Interfaces....	
15.	ENTER to access STATUS Interfaces .	
16.	STATUS Interfaces Highlight Internet .	
17.	IFACE (F3) to access STATUS Ethernet .	
18.	STATUS Ethernet	31.5.6
19.	Check the Internet online status.	
20.	CONT (F1) to return to STATUS Interfaces .	
21.	CONT (F1) to return to GPS1200 Main Menu .	

34.2.2

Configuring to Connect to a Server

Requirements

The configurations from the previous chapter must have been completed. Refer to "34.2.1 Configuring an Access to the Internet".

Configure connect to a server step-by-step

The following table explains the most common settings. Refer to the stated chapter for more information on screens.

Step	Description	Refer to chapter
1.	Select Main Menu: Config...\Interfaces....	
2.	CONFIGURE Interfaces Highlight Real-Time .	
3.	EDIT (F3) to access CONFIGURE Real-Time Mode .	
4.	CONFIGURE Real-Time Mode <R-Time Mode: Rover> <R-Time Data:> Select the type of data to be received from the Internet. <Port: NETx>	22.3.4
5.	CONT (F1) to return to CONFIGURE Interfaces .	
6.	Highlight Real-Time .	
7.	CTRL (F4) to access CONFIGURE Set NET Port .	
8.	CONFIGURE Set NET Port <User: Client>	24.8

Step	Description	Refer to chapter
	<p><Server:> The server to be accessed in the Internet. Opening the choicelist accesses CONFIGURE Server to Connect where new servers can be created and existing servers can be selected or edited.</p> <p><IP Address:> The stored IP address of the selected <Server:> to be accessed in the Internet.</p> <p><TCP/IP Port:> The stored port of the selected Internet <Server:> through which the data is provided. Each server has several ports for various services.</p> <p><Auto CONEC: Yes> Allows for automatic connection between the rover and the Internet when a point is occupied during a survey. Ending the point occupation also ends the Internet connection.</p>	24.11
9.	CONT (F1) to return to CONFIGURE Interfaces.	
	Once the receiver is connected to the server a message is displayed in the message line.	
10.	CONT (F1) to return to GPS1200 Main Menu.	
11.	USER	
12.	STAT (F3) to access STATUS Status Menu.	
13.	Highlight Interfaces....	
14.	ENTER to access STATUS Interfaces.	
15.	STATUS Interfaces	

Step	Description	Refer to chapter
	Highlight Real-Time .	
16.	DEVCE (F5) to access STATUS Device: Internet .	
17.	STATUS Device: Internet Check the Internet online status.	
18.	CONT (F1) to return to STATUS Interfaces .	
19.	CONT (F1) to return to GPS1200 Main Menu .	

34.2.3

Using the NTRIP Service with a Real-Time Rover



Requirements

The configurations from the previous chapter must have been completed. Refer to "34.2.2 Configuring to Connect to a Server".

Use NTRIP service step-by-step

Step	Description
1.	Select Main Menu: Config...Interfaces...
2.	In CONFIGURE Interfaces highlight Real-Time .
3.	EDIT (F3) to access CONFIGURE Real-Time Mode .
4.	CONFIGURE Real-Time Mode <Port: NETx> must be selected.
5.	ROVER (F2) to access CONFIGURE Additional Rover Options .
6.	PAGE (F6) to access CONFIGURE Additional Rover Options, NTRIP page.
7.	CONFIGURE Additional Rover Options, NTRIP page
8.	<Use NTRIP: Yes> <User ID:> A user ID is required to receive data from to the NTRIP Caster. Contact the NTRIP administrator for information. <Password:> A password is required to receive data from the NTRIP Caster. Contact the NTRIP administrator for information.
9.	SRCE (F5) to access CONFIGURE NTRIP Source-Table .
10.	CONFIGURE NTRIP Source-Table All MountPoints are listed. MountPoints are the NTRIP servers sending out real-time data. This screen consists of two columns:

Step	Description
	<ul style="list-style-type: none"> • First column MountPoint: The abbreviations for the MountPoints. • Second column Identifier: The city where the MountPoint is located. <p>Highlight a MountPoint about which more information is required. This information helps to configure the receiver to use the selected MountPoint as a reference.</p>
11.	INFO (F3) to access CONFIGURE MountPoint: XX .
12.	<p>CONFIGURE MountPoint: XX, General page</p> <p><Format:> The real-time data format sent out by the MountPoint.</p> <p><FormatDet:> Details about <Format:>, for example the RTCM message types including update rates in seconds displayed in brackets.</p> <p><Authentic:> The type of password protection required for the authorisation to the NTRIP Server. <Authentic: None> if no password is required. <Authentic: Basic> if the password need not be encrypted. <Authentic: Digest> if the password must be encrypted.</p> <p><NMEA:> Indicates if the MountPoint must receive GGA NMEA data from the rover in order to compute VRS information.</p> <p><Charges:> Indicates if charges are currently made for the connection.</p> <p><Carrier:> The type of carrier message sent out.</p> <p><System:> The type of satellite system supported by the MountPoint.</p>
13.	PAGE (F6) to access CONFIGURE MountPoint: XX, Location page.
14.	CONFIGURE MountPoint: XX, Location page

Step	Description
	Detailed information about the location of the MountPoint is displayed.
15.	PAGE (F6) to access CONFIGURE MountPoint: XX, Miscell page.
16.	CONFIGURE MountPoint: XX, Miscell page <Generator:> The hard- or software generating the data stream. <Compress:> The name of the compression / encryption algorithm. <Info:> Miscellaneous information if available.
	PREV (F2) to display information about the previous MountPoint in the list.
	NEXT (F3) to display information about the next MountPoint in the list.
17.	CONT (F1) to return to CONFIGURE NTRIP Source-Table .
18.	CONT (F1) to return to CONFIGURE Additional Rover Options .
	SHIFT CONEC (F3) and SHIFT DISCO (F3) are now available in all applications to connect to and disconnect from the NTRIP Server.

34.3

Configuring a GRX1200 Pro/GRX1200 GG Pro for Connecting a NTRIP Server

Description

A NTRIP Server is built into the GRX1200 Pro/GRX1200 GG Pro. It is part of the instrument firmware.

Using port NET, a GRX1200 Pro/GRX1200 GG Pro can be set up as a real-time reference connected to the Internet. Real-time data can be sent to the NTRIP Caster.





LEICA GPS Spider is needed to start the GRX1200 Pro/GRX1200 GG Pro and connect it to the NTRIP Caster since a GRX1200 Pro/GRX1200 GG Pro cannot be started using the RX1200. Once the sensor is started, LEICA GPS Spider can be disconnected and is no longer needed. All functionality needed from LEICA GPS Spider to start the GRX1200 Pro/GRX1200 GG Pro does not require a dongle and can be downloaded from the Leica website download area.



Configure a GRX1200 Pro/GRX1200 GG Pro step-by-step

The following table explains the most common settings. Refer to the stated chapter for more information on screens.

Step	Description	Refer to chapter
	The following steps describe the configuration for connecting from LEICA GPS Spider.	
1.	Configure the NET parameters.	20.5
2.	Select Main Menu: Config...Interfaces...	
3.	Highlight Remote .	
4.	EDIT (F3) to access CONFIGURE Remote .	
5.	CONFIGURE Remote	

Step	Description	Refer to chapter
	Highlight NET2 . This port is to connect from LEICA GPS Spider.	
6.	CTRL (F4) to access CONFIGURE Set NET Port .	
7.	CONFIGURE Set NET Port <User: Server>	
8.	CONT (F1) to return to CONFIGURE Interfaces .	
	The configuration for the connection from LEICA GPS Spider is finished. In the following steps describe the configuration to access the NTRIP Caster via Internet.	
9.	Highlight Real-Time .	
10.	EDIT (F3) to access CONFIGURE Real-Time Mode .	
11.	CONFIGURE Real-Time Mode <Port: NET1> This port is to connect to the NTRIP Caster.	
12.	REF (F2) to access CONFIGURE Additional Reference Options .	
13.	PAGE (F6) to change to CONFIGURE Additional Reference Options, NTRIP page.	
14.	CONFIGURE Additional Reference Options, NTRIP page <Use NTRIP: Yes> Type in password and MountPoint.	
15.	CONT (F1) to return to CONFIGURE Real-Time Mode .	

Step	Description	Refer to chapter
16.	CONT (F1) to return to CONFIGURE Interfaces .	
17.	CONFIGURE Interfaces Highlight Real-Time and check that NET1 is displayed for the Real-Time interface.	
18.	CTRL (F4) to access CONFIGURE Set NET Port .	
19.	CONFIGURE Set NET Port <User Client> <Auto CONEC: Yes>	
20.	CONT (F1) to return to GPS1200 Main Menu .	
	The configuration to access the NTRIP Caster via Internet is finished.	
	Ensure that the GRX1200 Pro/GRX1200 GG Pro is in GPS1200 Main Menu when connecting from LEICA GPS Spider else uploading the settings or starting the receiver may fail.	
	The receiver is now prepared for streaming real-time data to the NTRIP Caster.	
	LEICA GPS Spider is needed to connect the receiver to the NTRIP Caster. Real-time parameters can also be configured using LEICA GPS Spider.	
21.	Install LEICA GPS Spider.	
22.	Start LEICA GPS Spider.	

Step	Description	Refer to chapter
23.	Create a site.	online help in LEICA GPS Spider
24.	Connect to the receiver.	
25.	Configure the real-time output settings as required.	
26.	Select port NET1 which has previously been configured as Client.	
27.	Upload the settings to the GRX1200 Pro/GRX1200 GG Pro.	
28.	Press Start.	
	<p>The GRX1200 Pro/GRX1200 GG Pro connects automatically to the NTRIP Caster.</p> <p>Streaming of real-time data starts and continues until the site is stopped again.</p> <p>A message on the RX controller will indicate if the connection to the NTRIP Caster is successful.</p>	
	<p>In case of connection interruptions, which could be caused by power or network outages, the GRX1200 Pro/GRX1200 GG Pro will automatically reconnect to the NTRIP Caster.</p>	
	LEICA GPS Spider can be closed.	

35**Reference Station****Description**

The GRX1200 Series

- are designed to operate for specific reference station applications using remote control software, for example LEICA GPS Spider reference station software.
- support internal logging of raw observations which can be downloaded using an external remote control software package such as LEICA GPS Spider.
- support streaming output of GNSS raw observations and status information.
- can log or stream out data from specific external devices approved by Leica Geosystems, such as meteo and tilt, which can be directly output to an external remote control software package.
- can be used, with a suitable radio, digital cellular phone or modem attached, to transmit data for real-time operations using proprietary as well as standard RTCM, CMR and CMR+ formats. The GRX1200 Series cannot receive reference station broadcasts and therefore cannot be used as a real-time rover receiver.
- have the same receiver and measurement performance as the other GPS1200 receivers.

Special features

To operate for specific reference station applications, the GRX1200 Series is, when compared with the other GPS1200 receivers, equipped with some special features.

Specific to the GRX1200 Series:

- Controllable dual external power supply
- Support of external devices such as meteo and tilt
- Onboard RINEX (normal and compressed)
- Support of DynDNS

- Support of RTK multiplexing (up to 20 RTK clients)

Additional features for GRX1200 Classic and GRX1200 Pro:

- Ring buffer logging

Additional features for GRX1200 Pro:

- One Ethernet port including three logical NET ports
- One port to output PPS
- One port to input event messages
- One port for input from an external oscillator

Additional features for GRX1200 GG Pro:

- One Ethernet port including three logical NET ports
- One port to output PPS
- One port to input event messages
- One port for input from an external oscillator



Refer to the GPS1200 User Manual for more information on the equipment setup and getting started.



Refer to the other chapters in this manual for information on functionality.

36**Application Programs - General**

36.1**Overview**

Description

Application programs are software packages supporting specific tasks. Available are:

- COGO
- Determine Coordinate System
- DTM Stakeout
- DXF Export
- DXF Import
- Reference Line
- Reference Plane
- RoadRunner
- Stakeout
- Survey
- Survey Cross Section
- Volume Calculations
- Wake-Up
- Customised application programs

For an explanation of the application programs refer to the relevant chapters. The RoadRunner application program is explained in a separate manual.

Loadable and non-loadable application programs

- Loadable application programs:
- Can be loaded onto the receiver.
 - Can be deleted from the receiver.
- Non-loadable application program:
- Are always available on the receiver.
 - Survey and Wake-Up are a non-loadable application programs. To get an update for the programs, the system software has to be reloaded.
-

Licence key

Some loadable application programs are protected. They are activated through a specific licence key. This can either be typed in in **Main Menu: Tools... \Licence Keys** or the first

time the application program is started. Refer to "30 Tools...\Licence Keys" for information on how to type in or upload a licence key. A licence key is required for:

- DTM Stakeout
- DXF Export
- Reference Line
- Reference Plane
- RoadRunner
- Volume Calculations

Customised application programs

Customised application programs can be developed locally using the GeoC++ development environment. Information on the GeoC++ development environment is available on request from the Leica Geosystems representative.

Customised application programs always run in the language they were developed in.

36.2

Accessing the Application Programs Menu

Description

The application programs menu contains all loaded application programs including Survey. They are listed in the order in which they were loaded. Selecting an option in the menu starts the application program assigned to the option. Configurations and measurements that can be performed depend on the application program.

The screen of the application programs menu is called **GPS1200 Programs**.

Access to the application programs menu

Select **Main Menu: Programs....**

OR

Press **PROG**.

GPS1200 Programs



CONT (F1)

To start the highlighted application program.

Next step

Select an option in the menu to open the application. Refer to the chapter on the individual application programs.



Four application programs can be open at one time. **XX Begin** is shown for the application program opened first, but not for the following application programs.

37**COGO**

37.1**Overview**

Description

COGO is an application program to perform **coordinate geometry** calculations such as

- coordinates of points.
- bearings between points.
- distances between points.

The calculations can be made from

- existing point data in the job, known distances or known azimuths.
- manually occupied points.
- entered coordinates.

In contrast to hidden point measurements within the Survey application program, COGO is more of a calculation program than a measuring program.



Changing coordinates of a point which has been previously used in COGO does not result in the point being recomputed.

COGO calculation methods

The COGO calculation methods are:

- Inverse.
 - Traverse.
 - Intersections.
 - Line calculations.
 - Arc calculations.
 - Shift, Rotate & Scale (Manual)
 - Shift, Rotate & Scale (Match Pts)
 - Area Division
-

Distances and azimuths	Type of distances: The choices are <ul style="list-style-type: none"> • Ground • Grid • Ellipsoidal Type of azimuths: The azimuths are grid azimuths relative to the local grid.
Coding of COGO points	<ul style="list-style-type: none"> • Thematical coding is available in COGO XX Results after the COGO calculation. Thematical coding of COGO points is identical to coding manually occupied points. Refer to "11 Coding" for information on coding. • For the COGO calculation shift, rotate & scale, the codes from the original points are taken over for the calculated COGO points.
Properties of COGO points	The properties stored with COGO points are: <ul style="list-style-type: none"> • Class: Either MEAS or CTRL depending on the COGO configuration. • Sub class: COGO • Source: Arc Base Pt, Arc Centre Pt, Arc Offset Pt, Arc Segmt Pt, COGO Area Divsn., COGO Shift/Rtn, COGO Traverse, Intsct (Brg Brg), Intsct (Brg Dst), Intsct (Dst Dst), Intsct (4 Pts), Line Base Pt, Line Offset Pt or Line Segmt Pt depending on the COGO calculation method used • Instrument source: GPS

37.2

Accessing COGO

Access

Select **Main Menu: Programs...\COGO**.

OR

Press **PROG**. Highlight **COGO. CONT (F1)**. Refer to "36.2 Accessing the Application Programs Menu" for information on the **PROG** key.

OR

Press a hot key configured to access the screen **COGO COGO Begin**. Refer to "6.1 Hot Keys" for information on hot keys.

OR

Press **USER**. Refer to "6.2 USER Key" for information on the **USER** key.



The screens for each COGO calculation method can be accessed directly by pressing a configured hot key or **USER** where **COGO COGO Begin** is not accessed. The currently active configuration set and job are used.

COGO
COGO Begin

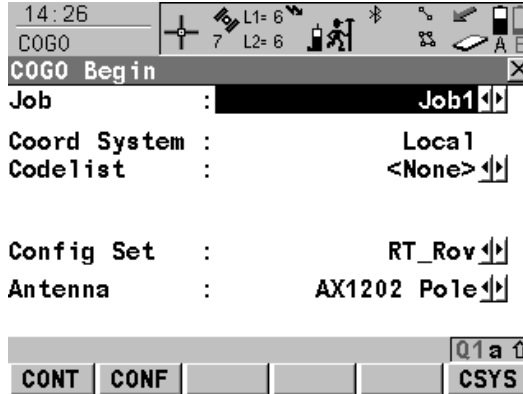

CONT (F1)

To accept changes and access the subsequent screen. The chosen settings become active.

CONF (F2)

To configure the COGO application program. Accesses **COGO Configuration**. Refer to "37.3 Configuring COGO".

CSYS (F6)

To select a different coordinate system.

Description of fields

Field	Option	Description
<Job:>	Choicelist	The active job. All jobs from Main Menu: Manage...\Jobs can be selected.
<Coord System:>	Output	The coordinate system currently attached to the selected <Job:>.
<Codelist:>	Choicelist	No codes are stored in the selected <Job:>. All codelists from Main Menu: Manage...\Codelists can be selected.

Field	Option	Description
	Output	Codes have already been stored in the selected <Job:> . If codes had been copied from a System RAM codelist, then the name of the codelist is displayed. If codes have not been copied from a System RAM codelist but typed in, then the name of the active job is displayed.
<Config Set:>	Choicelist	The active configuration set. All configuration sets from Main Menu: Manage...\Configuration Sets can be selected.
<Antenna:>	Choicelist	The antenna currently defined to be used in the selected configuration set. All antennas from Main Menu: Manage...\Antennas can be selected.

Next step

CONT (F1) accepts changes and accesses **COGO COGO Menu**.

COGO COGO Menu

The COGO menu lists all COGO calculation methods and the option to end COGO.

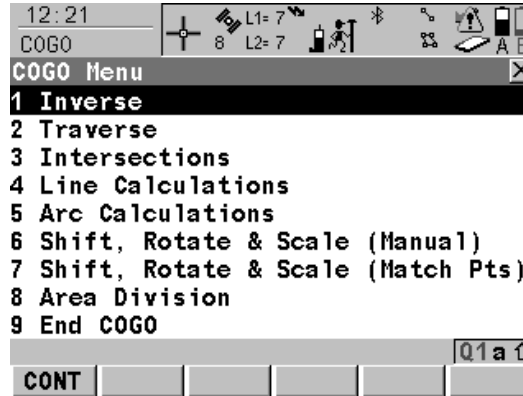

CONT (F1)

To select the highlighted option and to continue with the subsequent screen.

SHIFT CONF (F2)

To configure the COGO application program. Accesses **COGO Configuration**. Refer to "37.3 Configuring COGO".

Description of the COGO menu options

COGO menu options	Description	Refer to chapter
Inverse	<p>To calculate the direction, the distance and the 3D coordinate differences between two known points.</p> <p>To calculate the direction, the distance and the 3D coordinate differences between a known point and a given line using</p> <ul style="list-style-type: none"> two known points and an offset point (known point or current position). 	37.4

COGO menu options	Description	Refer to chapter
	<ul style="list-style-type: none"> • a bearing and a distance from a known point and an offset point. <p>To calculate the direction, the distance and the 3D coordinate differences between a known point and a given arc.</p> <p>The arc can be defined using</p> <ul style="list-style-type: none"> • three points. • a radius to two known points. • a radius and two tangents, each of it defined by a point and the intersection point of the tangents. • the length of an arc and two tangents, each of it defined by a point and the intersection point of the tangents. • the length of a chord and two tangents, each of it defined by a point and the intersection point of the tangents. <p>To calculate the direction, the distance and the 3D coordinate differences between a known point and the current position.</p> <p>Points with full coordinate triplets and position only points can be used.</p>	
Traverse	To calculate the position of new points using	37.5

COGO menu options	Description	Refer to chapter
	<ul style="list-style-type: none"> • the azimuth/bearing and the distance from a known point. Offset optional. • the angle and the distance from a known point. Offset optional. <p>Points with full coordinate triplets and position only points can be used.</p>	
Intersections	<p>To calculate the position of an intersection point using</p> <ul style="list-style-type: none"> • bearings from two known points. • a bearing and a distance from two known points. • distances from two known points. • four points. • two lines <p>Points with full coordinate triplets and position only points can be used.</p>	37.6
Line Calculations	<p>To calculate the base point of the line using</p> <ul style="list-style-type: none"> • two known points and an offset point. • a bearing and a distance from a known point and an offset point. <p>To calculate the offset point of the line using</p>	37.7

COGO menu options	Description	Refer to chapter
	<ul style="list-style-type: none"> • two known points that define the line, a distance along the line and an offset. • a distance along a bearing from a known point and and offset. <p>To calculate new points on a line using</p> <ul style="list-style-type: none"> • two known points that define the line and either the segment length or the number of segments. • a bearing and distance from a known point that define the line and either the segment length or the number of segments. 	
<p>Arc Calculations</p>	<p>To calculate</p> <ul style="list-style-type: none"> • the arc centre. • the base point of the arc. • the offset point of the arc. • new points on an arc. <p>The arc can be defined using</p> <ul style="list-style-type: none"> • three points. • a radius to two known points. • a radius and two tangents, each of it defined by a point and the intersection point of the tangents. 	<p>37.8</p>

COGO menu options	Description	Refer to chapter
	<ul style="list-style-type: none"> • the length of an arc and two tangents, each of it defined by a point and the intersection point of the tangents. • the length of a chord and two tangents, each of it defined by a point and the intersection point of the tangents. <p>Known must be also, depending on the arc calculation method</p> <ul style="list-style-type: none"> • an offset point. • either the segment length or the number of segments. 	
Shift, Rotate & Scale (Manual)	<p>To calculate the position of new points using</p> <ul style="list-style-type: none"> • coordinates of known points • shifts. • rotation. • scale. Heights are not scaled. <p>The values for shifts, rotation and/or scale are entered manually.</p> <p>Points with full coordinate triplets, position only points and height only points can be used.</p>	37.9

COGO menu options	Description	Refer to chapter
Shift, Rotate & Scale (Match Pts)	To calculate the coordinates of new points using the shifts, rotation and scale computed from selected points. Points with full coordinate triplets, position only points and height only points can be used.	37.10
Area Division	To divide an area by a <ul style="list-style-type: none"> • defined line • percentage • size of a sub area. 	37.11
End COGO	To end COGO and return to the screen from where COGO was accessed.	

Next step

IF	THEN
a COGO calculation method is to be started	highlight the relevant option and press CONT (F1) . Refer to the chapters stated above.
COGO is to be configured	SHIFT CONF (F2) . Refer to "37.3 Configuring COGO".
COGO is to be ended	highlight End COGO and CONT (F1) .

37.3

Configuring COGO

Access

Select **Main Menu: Programs... \COGO**. In **COGO COGO Begin** press **CONF (F2)** to access **COGO Configuration**.

OR

Press **PROG**. Highlight **COGO**. **CONT (F1)**. In **COGO COGO Begin** press **CONF (F2)** to access **COGO Configuration**.

OR

Press **SHIFT CONF (F2)** in **COGO COGO Menu**. Refer to "37.2 Accessing COGO".

OR

Press **SHIFT CONF (F2)** in **COGO XX**.

COGO Configuration, Parameters page

This screen consists of the **Parameters** page, **Residuals** page and the **Logfile** page. The explanations for the softkeys given below are valid for all pages.

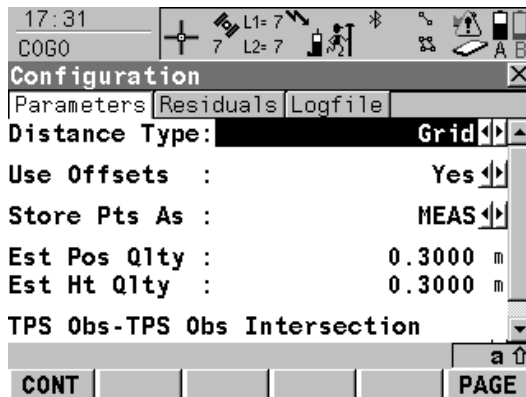

CONT (F1)

To accept changes and return to the screen from where this screen was accessed.

PAGE (F6)

To change to another page on this screen.

SHIFT ABOUT (F5)

To display information about the program name, the version number, the date of the version, the copyright and the article number.

Description of fields

Field	Option	Description
<Distance Type:>		The type of distances and offsets to be accepted as input or shown as output, and used in the calculation.
	Grid	Distances are calculated as the trigonometric distance between the position of two points. The distance field is <HDist-Grid:> .
	Ground	Distances are horizontal distances between two points at the mean elevation parallel to the ellipsoid of the active coordinate system. The distance field is <HDist-Grnd:> .
	Ellipsoid	Distances are reduced to the ellipsoid. They are calculated as the shortest distance between the two points on the ellipsoid. A scale factor is applied. The distance field is <HDist-Ell:> .  In the attached coordinate system, a projection, an ellipsoid and a transformation have to be defined to calculate grid, ground and ellipsoid coordinates.

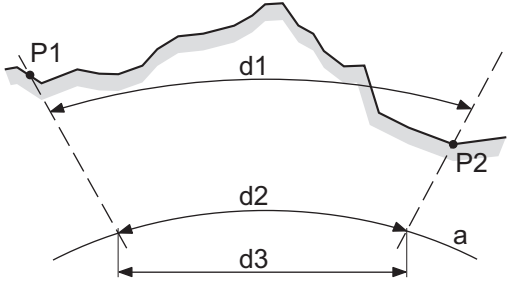
Field	Option	Description
 <p>a Ellipsoid Known P1 First known point P2 Second known point Unknown d1 Ground distance d2 Ellipsoid distance d3 Grid distance</p> <p>TPS12_170</p>		
<Use Offsets:>	Yes or No	Activates the use of offsets in the COGO calculations. Input fields for the offsets are available in COGO XX .
<Store Pts As:>	MEAS or CTRL	Defines the point class of COGO calculated and stored points as MEAS or CTRL triplets.
<Est Pos Qty:>	User input	The estimated value for the position quality assigned to all calculated COGO points which is used for the averaging calculation.
<Est Ht Qty:>	User input	The estimated value for the height quality assigned to all calculated heights which is used for the averaging calculation.
<TPS Obs - TPS Obs Intersection>	Output text	COGO method for which only the following configuration setting is valid.

Field	Option	Description
<Compute Ht:>		Defines the height being used within TPS Obs - TPS Obs Intersection.
	Using Average	Using an average of the two observations.
	Use Upper Height	Using the upper height.
	Use Lower Height	Using the lower height.

Next step

PAGE (F6) changes to the **Residuals** page. Refer to paragraph "COGO Configuration, Residuals page".

This page applies to COGO Shift, Rotate & Scale (Match Pts).

Description of fields

**COGO
Configuration,
Residuals page**

Field	Option	Description
<Easting:>	User input	The limit above which Easting residuals will be flagged as possible outliers.
<Northing:>	User input	The limit above which Northing residuals will be flagged as possible outliers.
<Height:>	User input	The limit above which Height residuals will be flagged as possible outliers.
<Residual Distbtn:>		The method by which the residuals of the control points will be distributed throughout the transformation area.

Field	Option	Description
	None	No distribution is made. Residuals remain with their associated points.
	1/Distance^{XX}	Distributes the residuals according to the distance between each control point and the newly transformed point.
	Multiquadratic	Distributes the residuals using a multiquadratic interpolation approach.

Next step

PAGE (F6) changes to the **Logfile** page. Refer to paragraph "COGO Configuration, Logfile page".

COGO Configuration, Logfile page

Description of fields

Field	Option	Description
<Write Logfile:>	Yes or No	To generate a logfile when the application program is exited. A logfile is a file to which data from an application program is written to. It is generated using the selected <Format File:> .

Field	Option	Description
<File Name:>	Choicelist	Available for <Write Logfile: Yes>. The name of the file to which the data should be written. A logfile is stored in the \DATA directory of the active memory device. The data is always appended to the file. Opening the choicelist accesses XX Logfiles where a name for a new logfile can be created and an existing logfile can be selected or deleted.
<Format File:>	Choicelist	Available for <Write Logfile: Yes>. A format file defines which and how data is written to a logfile. Format files are created using LGO. A format file must first be transferred from the CompactFlash card to the System RAM before it can be selected. Refer to "26 Tools...\Transfer Objects..." for information on how to transfer a format file. Opening the choicelist accesses XX Format Files where an existing format file can be selected or deleted.

Next step

PAGE (F6) changes to the first page on this screen.



<Azimuth:> is used throughout this chapter. This should always be considered to also mean <Bearing:>.

37.4

COGO Calculation - Inverse Method

37.4.1

Inverse Point - Point

Description

The direction, the distance and the coordinate differences between the two known points can be calculated depending on the data available for the known points. Points with full coordinate triplets, position only points and height only points can be used.

Elements that must be known are

- coordinates of two points.

The coordinates of the known points

- may be taken from the active job.
- may be manually occupied during the COGO calculation.
- may be entered.

Diagram

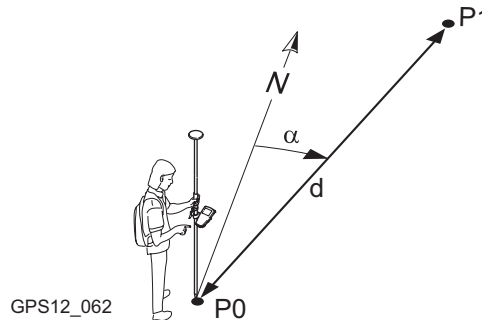

Known

- P0 First known point
- P1 Second known point

Unknown





- α Direction from P0 to P1
- d1 Slope distance between P0 and P1
- d2 Horizontal distance between P0 and P1
- d3 Height difference between P0 and P1



Access

Refer to "37.2 Accessing COGO" to access **COGO Inverse Input**.

COGO inverse calculation point - point step-by-step

The following table explains the most common settings. Refer to the stated chapter for more information on screens.

Step	Description	Refer to chapter
1.	Refer to "37.2 Accessing COGO" to access COGO Inverse .	
	COGO Inverse Input, Inverse page SHIFT CONF (F2) to configure the COGO application program.	37.3
2.	COGO Inverse Input, Inverse page <From:> The point ID of the first known point for the COGO calculation. <To:> The point ID of the second known point for the COGO calculation. Select the points to be used.	
	SURVY (F5) when <From:> or <To:> is highlighted. To manually occupy a point for the COGO calculation.	44.3
	For all point fields, the MapView interactive display on the Map page can be used to select the desired point.	32.5
	To type in coordinates for a known point open the choicelist when <From:> or <To:> is highlighted. Press NEW (F2) to create a new point.	9.3.2
3.	COGO Inverse Input, Inverse page The COGO calculation results are displayed on the same page.	37.4.1

Step	Description	Refer to chapter
	<p>The horizontal distance values which are displayed depend on the configuration for <Distance Type:> in COGO Configuration, Parameters page.</p> <p>----- is displayed for unavailable information, for example if a position only point is used, <Δ Height:> cannot be calculated.</p> <p><Azimuth:> The direction from the first to the second known point.</p> <p><HDist-XX:> The horizontal distance between the two known points.</p> <p><Δ Height:> The height difference between the two known points.</p> <p><Slope Dist:> The slope distance between the two known points.</p> <p><Grade:> The grade between the two known points.</p> <p><Δ Easting:> The difference in Easting between the two known points.</p> <p><Δ Northing:> The difference in Northing between the two known points.</p>	
4.	PAGE (F6) changes to the Map page.	
5.	COGO Inverse Input, Map page	32.5
	The calculated distance between the two known points is indicated.	
	SHIFT QUIT (F6) does not store the calculated results and exits COGO calculation.	
6.	STORE (F1) to store the result.	
	For <Write Logfile: Yes> in COGO Configuration, Logfile page the result is written to the logfile.	

Step	Description	Refer to chapter
7.	Are more inverse COGO calculations to be made? <ul style="list-style-type: none">• If yes, repeat steps 2. to 7.• If no, continue with step 8.	
8.	SHIFT QUIT (F6) to exit COGO calculation.	

37.4.2

Inverse Point - Line

Description

The direction, the distance and the coordinate differences between a known point and a given line can be calculated depending on the data available for the known points. Points with full coordinate triplets, position only points and height only points can be used.

Elements that must be known are

- coordinates of two points and an offset point.

OR

- coordinates of one point and an offset point
- bearing and distance from one point

The coordinates of the known points

- may be taken from the active job.
 - may be measured during the COGO calculation.
 - may be entered.
-

Diagram

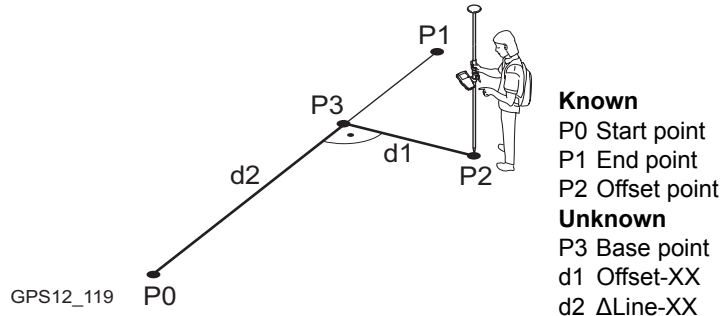

- Known**
 P0 Start point
 P1 End point
 P2 Offset point
- Unknown**
 P3 Base point
 d1 Offset-XX
 d2 ΔLine-XX

Access

Refer to "37.2 Accessing COGO" to access **COGO Inverse Pt - Line Input**.

COGO

Inverse Pt - Line Input, Input page

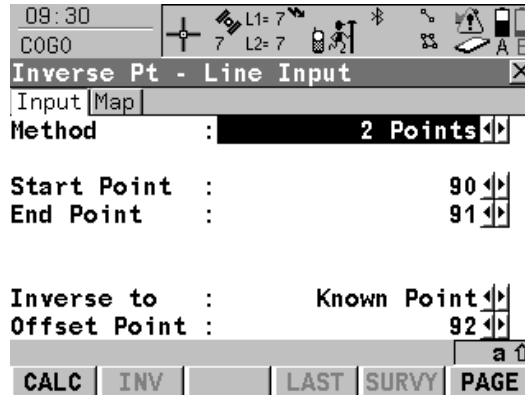

CALC (F1)

To calculate COGO point.

INV (F2)

To calculate the values for the distance and the offset from two existing points. Available if <Azimuth:> or <HDist-XX:> is highlighted.

LAST (F4)

To select the values for the distance and the offset from previous COGO inverse calculations. Available if <Azimuth:> or <HDist-XX:> is highlighted.

SURVY (F5)

To manually occupy a point for the COGO calculation. Available if **<Start Point:>** or **<End Point:>** is highlighted.

SHIFT CONF (F2)

To configure the COGO application program.

SHIFT MODIF (F4)

To mathematically modify the values. Available if **<Azimuth:>** or **<HDist-Grid:>** is highlighted.

Description of fields

Field	Option	Description
<Method:>	2 Points Pt/Brg/Dist	The method by which the line will be defined. Uses two known points to define the line. Defines the line using a known point, a distance and an azimuth of the line.
<Start Point:>	Choicelist	The start point of the line. All points from COGO Data: Job Name can be selected.
<End Point:>	Choicelist	Available for <Method: 2 Points> . The end point of the line. All points from COGO Data: Job Name can be selected.
<Azimuth:>	User input	Available for <Method: Pt/Brg/Dist> . The azimuth of the line.

Field	Option	Description
<HDist-Grid:>	User input	Available for <Method: Pt/Brg/Dist>. The horizontal distance from the start point to the end point of the line.
<Inverse to:>	Known Point Current Position	The method by which the inverse will be calculated. Inverse to a known point. All points from COGO Data: Job Name can be selected. Inverse to the current position.
<Offset Point:>	Choicelist	Available for <Inverse to: Known Point >. The offset point.

Next step

PAGE (F6) accesses **Map** page. Refer to paragraph "COGO Inverse Pt - Line Input, Map page".

COGO Inverse Pt - Line Input, Map page

The **Map** page provides an interactive display of the data. Refer to "32 MapView Interactive Display Feature" for information on the functionality and softkeys available.

Next step

CALC (F1) calculates and accesses **COGO Inverse Pt - Line Result**. Refer to paragraph "COGO Inverse Pt - Line Result, Result page".

COGO

Inverse Pt - Line Result, Result page

09:30
COGO
L1= 7 L2= 7
Inverse Pt - Line Result
Result Plot
Offset Point : 92
ΔLine-Grid : 36.825 m
ΔOffset-Grid : 1.833 m
Offs Pt Brng : 247°45'44"
Line Length : 21.456 m
Line Brng : 157°45'44"
a ↑
STORE COORD PAGE

STORE (F1)

To store result and to return to **COGO Inverse Pt - Line Input**.

COORD (F2)

To view other coordinate types.

PAGE (F6)

To change to another page on this screen.

SHIFT ELL H (F2) and SHIFT ORTH (F2)

To change between the ellipsoidal and the orthometric height.

Description of fields

Field	Option	Description
<Offset Point:>	Output	Point ID of offset point or <Current Position>.
<ΔLine-Grid:>	Output	Horizontal distance from start point to base point.
<ΔOffset-Grid:>	Output	Offset from base point to offset point. Positive to the right and negative to the left of the line.
<Line Length:>	Output	Length of line from start point to end point.
<Line Brng:>	Output	Bearing of line from start point to end point.
<Offs Pt Brng:>	Output	Bearing of offset point from base point to offset point.

Next step

PAGE (F6) changes to the **Plot** page.

COGO
Inverse Pt - Line Result,
Plot page

The functionality of the **Plot** page is similar to **COGO Traverse Results, Plot** page.

Next step

STORE (F1) stores the result and returns to **COGO Inverse Pt - Line Input, Input** page.

37.4.3

Inverse Point - Arc

Description

The direction, the distance and the coordinate differences between a known point and a given arc can be calculated depending on the data available for the known points. Points with full coordinate triplets, position only points and height only points can be used.

Elements that must be known are

- coordinates of three points
- coordinates of an offset point

OR

- coordinates of two points
- radius to the two points
- coordinates of an offset point

The coordinates of the known points

- may be taken from the active job.
 - may be measured during the COGO calculation.
 - may be entered.
-

Diagram

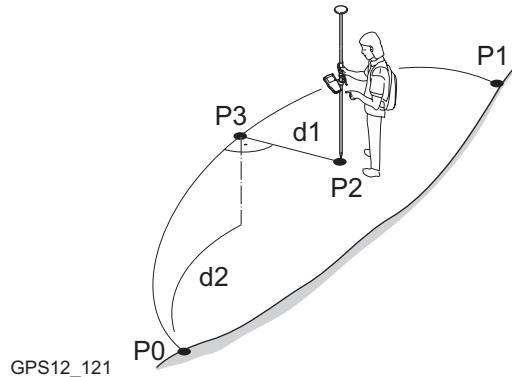

Known

- P0 Start point
- P1 End point
- P2 Offset point

Unknown

- P3 Base point
- d1 Offset-XX
- d2 ΔArcDist-XX

Access

Refer to "37.2 Accessing COGO" to access **COGO Inverse Pt - Arc Input**.

COGO

Inverse Pt - Arc Input,
Input page

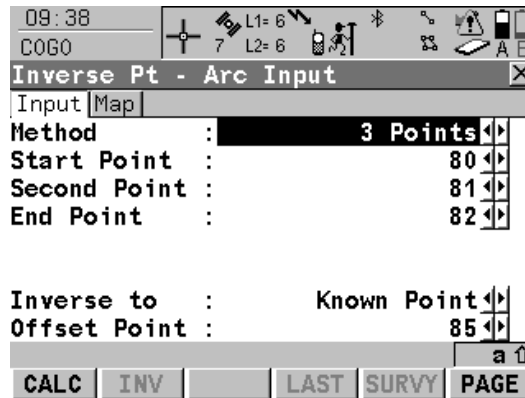

CALC (F1)

To calculate COGO point.

INV (F2)

To calculate the values for the distance and the offset from two existing points. Available if **<Radius:>**, **<Arc Length:>** or **<Chord Length:>** is highlighted.

LAST (F4)

To select the values for the distance and the offset from previous COGO inverse calculations. Available if **<Radius:>**, **<Arc Length:>** or **<Chord Length:>** is highlighted.

SURVY (F5)

To manually occupy a point for the COGO calculation. Available if **<Start Point:>**, **<Second Point:>**, **<End Point:>** or **<Offset Point:>** is highlighted.

SHIFT CONF (F2)

To configure the COGO application program.

SHIFT MODIF (F4)

To mathematically modify the values. Available if **<Radius:>**, **<Arc Length:>** or **<Chord Length:>** is highlighted.

Description of fields

Field	Option	Description
<Method:>	3 Points	The method by which the arc will be defined. Uses three known points to define the arc.
	2 Points/Radius	Defines the arc using two known points and a radius of the arc.
	2 Tgnts/Radius	Defines the arc using two tangents and a radius of the arc.
	2 Tgnts/Arc Lngt	Defines the arc using two tangents and the length of the arc.
	2 Tgnts/Chrd Lngt	Defines the arc using two tangents and the chord of the arc.

Field	Option	Description
<Start Point:>	Choicelist	The start point of the arc. All points from COGO Data: Job Name can be selected. Available for <Method: 3 Points> and <Method: 2 Points/Radius>.
<Second Point:>	Choicelist	All points from COGO Data: Job Name can be selected. Available for <Method: 3 Points>. The second point of the arc.
<End Point:>	Choicelist	The end point of the arc. All points from COGO Data: Job Name can be selected. Available for <Method: 3 Points> and <Method: 2 Points/Radius>.
<Point 1:>	Choicelist	A point on the first tangent. Available for <Method: 2 Tgnts/Radius>, <Method: 2 Tgnts/Arc Lngt> and <Method: 2 Tgnts/Chrd Lngt>.
<PI Point:>	Choicelist	The point of intersection of the two tangents. Available for <Method: 2 Tgnts/Radius>, <Method: 2 Tgnts/Arc Lngt> and <Method: 2 Tgnts/Chrd Lngt>.
<Point 2:>	Choicelist	A point on the second tangent. Available for <Method: 2 Tgnts/Radius>, <Method: 2 Tgnts/Arc Lngt> and <Method: 2 Tgnts/Chrd Lngt>.
<Radius:>	User input	The radius of the arc. Available for <Method: 2 Points/Radius> and <Method: 2 Tgnts/Radius>.
<Arc Length:>	User input	The length of the arc. Available for <Method: 2 Tgnts/Arc Lngt>.

Field	Option	Description
<Chord Length:>	User input	The length of the chord. Available for <Method: 2 Tgnts/Chrd Lngt>.
<ΔArcDist-Grid:>	User input	Horizontal distance along the arc from start point to base point.
<ΔOffset-Grid:>	User input	Offset from base point to offset point. Positive to the right and negative to the left of the arc.
<Inverse to:>	<p>Known Point</p> <p>Current Position</p>	<p>The method by which the inverse will be calculated.</p> <p>Inverse to a known point. All points from COGO Data: Job Name can be selected.</p> <p>Inverse to the current position.</p>
<Offset Point:>	Choicelist	Available for <Inverse to: Known Point>. The offset point.

Next step

PAGE (F6) accesses **Map** page. Refer to paragraph "COGO Inverse Pt - Arc Input, Map page".

COGO Inverse Pt - Arc Input, Map page

The **Map** page provides an interactive display of the data. Refer to "32 MapView Interactive Display Feature" for information on the functionality and softkeys available.

Next step

CALC (F1) calculates and accesses **COGO Inverse Pt - Arc Result**. Refer to paragraph "COGO Inverse Pt - Line Result, Result page".

COGO
Inverse Pt - Arc Result,
Result page

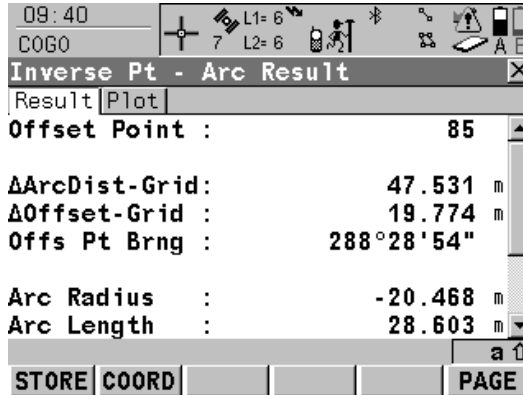

- STORE (F1)**
To store result and to return to **COGO Inverse Pt - Line Input**.
- COORD (F2)**
To view other coordinate types.
- PAGE (F6)**
To change to another page on this screen.
- SHIFT ELL H (F2) and SHIFT ORTH (F2)**
To change between the ellipsoidal and the orthometric height.

Description of fields

Field	Option	Description
<Offset Point:>	Output	Point ID of offset point for <Inverse to: Known Point> or current position.
<ΔArcDist-Grid:>	Output	Horizontal distance along the arc from start point to base point.
<ΔOffset-Grid:>	Output	Offset from base point to offset point. Positive to the right and negative to the left of the line.
<Offs Pt Brng:>	Output	Bearing of offset point from base point to offset point.
<Arc Radius:>	Output	Computed radius of arc.

Field	Option	Description
<Arc Length:>	Output	Computed length of arc.

Next step

PAGE (F6) changes to the **Plot** page.

The functionality of the **Plot** page is similar to **COGO Traverse Results, Plot** page.

Next step

STORE (F1) stores the result and returns **COGO Inverse Pt - Arc Input, Input** page.

COGO
Inverse Pt - Arc Result,
Plot page

37.4.4

Inverse Point - Current Position

Description

The direction, the distance and the coordinate differences between the two known points can be calculated depending on the data available for the known points. Points with full coordinate triplets, position only points and height only points can be used.

Elements that must be known are

- coordinates of two points.

The coordinates of the known points

- may be taken from the active job.
- may be manually occupied during the COGO calculation.
- may be entered.

Diagram

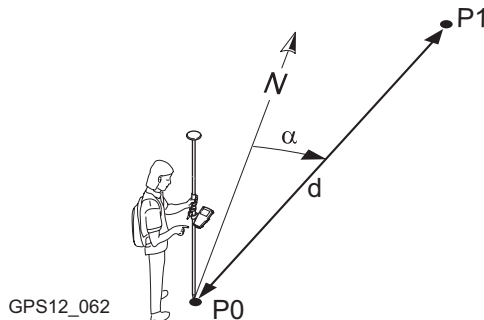

Known

- P0 Current position
- P1 Second known point

Unknown





- α Direction from P0 to P1
- d1 Slope distance between P0 and P1
- d2 Horizontal distance between P0 and P1
- d3 Height difference between P0 and P1

Access



Refer to "37.2 Accessing COGO" to access **COGO Inverse Pt - Current Pos.**

COGO inverse calculation point - current position step-by-step

The following table explains the most common settings. Refer to the stated chapter for more information on screens.

Step	Description	Refer to chapter
1.	Refer to "37.2 Accessing COGO" to access COGO Inverse .	
	COGO Inverse Pt - Current Pos, Inverse page SHIFT CONF (F2) to configure the COGO application program.	37.3
2.	COGO Inverse Pt - Current Pos, Inverse page <From:> The point ID of the current position for the COGO calculation. <To:> The point ID of the second known point for the COGO calculation. REVRS (F3) to switch the options of the fields <From:> and <To:> . Select the points to be used.	
	SURVY (F5) when <From:> or <To:> is highlighted. To manually occupy a point for the COGO calculation.	44.3
	For all point fields, the MapView interactive display on the Map page can be used to select the desired point.	32.5
	To type in coordinates for a known point open the choicelist when <From:> or <To:> is highlighted. Press NEW (F2) to create a new point.	9.3.2
3.	COGO Inverse Pt - Current Pos, Inverse page The COGO calculation results are displayed on the same page.	37.4.4

Step	Description	Refer to chapter
	<p>The horizontal distance values which are displayed depend on the configuration for <Distance Type:> in COGO Configuration, Parameters page.</p> <p>---- is displayed for unavailable information, for example if a position only point is used, <Δ Height:> cannot be calculated.</p> <p><Azimuth:> The direction from the current position to the second known point.</p> <p><HDist-XX:> The horizontal distance between the known point and the current position.</p> <p><Δ Height:> The height difference between the known point and the current position.</p> <p><Slope Dist:> The slope distance between the known point and the current position.</p> <p><Grade:> The grade between the known point and the current position.</p> <p><Δ Easting:> The difference in Easting between the known point and the current position.</p> <p><Δ Northing:> The difference in Northing between the known point and the current position.</p>	
4.	PAGE (F6) changes to the Map page.	
5.	COGO Inverse Pt - Current Pos, Map page	32.5

Step	Description	Refer to chapter
	The calculated distance between the known point and the current position is indicated.	
	SHIFT QUIT (F6) does not store the calculated results and exits COGO calculation.	
6.	STORE (F1) to store the result.	
	For < Write Logfile: Yes > in COGO Configuration, Logfile page the result is written to the logfile.	
7.	Are more inverse COGO calculations to be made? <ul style="list-style-type: none"> • If yes, repeat steps 2. to 7. • If no, continue with step 8. 	
8.	SHIFT QUIT (F6) to exit COGO calculation.	

37.5

COGO Calculation - Traverse Method

37.5.1

Overview

Description

Elements that must be known are

- the coordinates of one point.
- the direction from the known point to the COGO point.
- the distance from the known point to the COGO point.
- offsets, if required and configured.

The coordinates of the known point

- may be taken from the active job.
- may be manually occupied during the COGO calculation.
- may be entered.

The direction from the known point to the COGO point can be an azimuth or an angle.

Points with full coordinate triplets and position only points can be used. Position only is calculated, height can be typed in.

A COGO traverse calculation can be calculated for

- a single point.
 - multiple points. Several single points are calculated in one sequence.
 - sideshots.
-

Diagram

COGO traverse calculation with offset for a single point

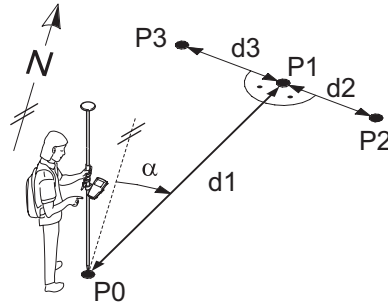

GPS12_106

Known

- P0 Known point
- α Direction from P0 to P1
- d1 Distance between P0 and P1
- d2 Positive offset to the right
- d3 Negative offset to the left

Unknown

- P1 COGO point without offset
- P2 COGO point with positive offset
- P3 COGO point with negative offset

COGO traverse calculation without offset for multiple points

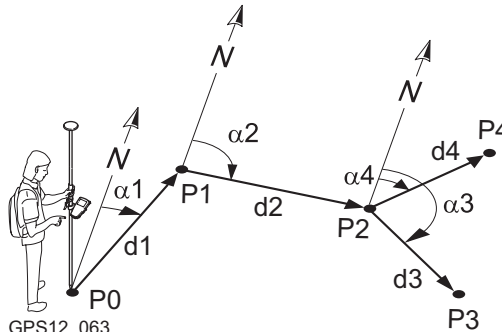

GPS12_063

Known

- P0 Known point
- $\alpha1$ Direction from P0 to P1
- $\alpha2$ Direction from P1 to P2
- $\alpha3$ Direction from P2 to P3
- $\alpha4$ Direction from P2 to P4
- d1 Distance between P0 and P1
- d2 Distance between P1 and P2
- d3 Distance between P2 and P3
- d4 Distance between P2 and P4

Unknown





- P1 First COGO point
 - P2 Second COGO point
 - P3 Third COGO point - sideshot
 - P4 Fourth COGO point
-





37.5.2

Traverse with Azimuth/Bearing





COGO traverse calculation with azimuth/bearing step-by-step



The following table explains the most common settings. Refer to the stated chapter for more information on screens.

Step	Description	Refer to chapter
1.	Refer to "37.2 Accessing COGO" to access COGO Traverse Input .	
	COGO Traverse Input, Input page SHIFT CONF (F2) to configure the COGO application program.	37.3
2.	COGO Traverse Input, Input page <Method: Azimuth> <From:> The point ID of the known point for the COGO calculation. Select a point to be used.	
	SURVY (F5) when <From:> is highlighted. To manually occupy a point for the COGO calculation.	44.3
	For all point fields, the MapView interactive display on the Map page can be used to select the desired point.	32.5
	To type in coordinates for a known point open the choicelist when <From:> is highlighted. Press NEW (F2) to create a new point.	9.3.2
3.	COGO Traverse Input, Input page <Azimuth:> The direction from the known point to the COGO point. <HDist-XX:> The horizontal distance between the known point and the COGO point.	

Step	Description	Refer to chapter
	<p><Offset:> Available for <Use Offsets: Yes> in COGO Configuration, Parameters page. The offset of the COGO point from the line of direction. A positive offset is to the right, a negative offset is to the left.</p> <p>Type in the azimuth, the distance and the offset, if required.</p>	
	<p>The values for the azimuth, the distance and the offset can be calculated from two existing points.</p> <p>INV (F2) when <Azimuth:>, <HDist-XX:> or <Offset:> is highlighted. To perform a COGO inverse calculation.</p> <p> Upon pressing STORE (F1) in COGO Inverse, the result from the COGO inverse calculation is copied to the field which was highlighted when INV (F2) was pressed.</p> <p> For <Write Logfile: Yes> in COGO Configuration, Logfile page the result of the COGO inverse calculation is written to the logfile.</p>	37.4
	<p>The values for the azimuth, the distance and the offset can be selected from previous COGO inverse calculations.</p> <p>LAST (F4) when <Azimuth:>, <HDist-XX:> or <Offset:> is highlighted. To recall previous results from COGO inverse calculations. Upon pressing CONT (F1) in COGO Last Inverse Calculations, the selected result is copied to the field which was highlighted when LAST (F4) was pressed.</p>	37.12

Step	Description	Refer to chapter
	<p>The values for the azimuth, the distance and the offset can be mathematically modified.</p> <p>SHIFT MODIF (F4) when <Azimuth:>, <HDist-XX:> or <Offset:> is highlighted. To add, subtract, multiply and divide values.</p>	37.13
4.	<p>Is the COGO point a foresight?</p> <ul style="list-style-type: none"> • If yes, CALC (F1). • The result is calculated and displayed in COGO Traverse Results. After storing the result and returning to COGO Traverse Input, Input page, the point displayed in <From:> is the newly calculated COGO point. The next COGO calculation can be continued from this new point. • If no, SSHOT (F3). <p>The result is calculated and displayed in COGO Traverse Results. After storing the result and returning to COGO Traverse Input, Input page, the point originally selected in <From:> is still displayed. The next COGO calculation can be continued from that same point.</p>	
5.	<p>COGO Traverse Results, Result page</p> <p><Point ID:> The identifier for the COGO point depending on the point ID template configured for <Survey Pts:> in CONFIGURE ID Templates. The point ID can be changed.</p>	19.1

Step	Description	Refer to chapter
	<p><Ortho Ht:> or <Local Ell Ht:> are input fields. The height of the known point used in the COGO calculation is suggested. A height value to be stored with the calculated point can be typed in.</p> <p>The calculated coordinates are displayed.</p> <p>Type in a point ID.</p>	
	COORD (F2) views other coordinate types.	
	<p>STAKE (F5) to access the Stakeout application program and stake out the calculated COGO point.</p> <p>After staking, measuring and storing the COGO point, COGO Traverse Results, Result page is displayed.</p>	43.4
	SHIFT ELL H (F2) and SHIFT ORTH (F2) . Available for local coordinates. Changes between the ellipsoidal and the orthometric height.	
	SHIFT INDIV (F5) for an individual point ID independent of the ID template. SHIFT RUN (F5) changes back to the next ID from the configured ID template.	19.1
6.	PAGE (F6) changes to the Code page.	
7.	<p>COGO Traverse Results, Code page</p> <p><Code:>/<Point Code:> The thematical code. All codes of the job can be selected.</p> <p>Type in a code if required.</p>	11, 9.3.2
8.	PAGE (F6) changes to the Plot page.	

Step	Description	Refer to chapter
9.	COGO Traverse Results, Plot page An arrow points from the known point to the calculated COGO point.	32.6
	SHIFT QUIT (F6) does not store the COGO point and exits COGO calculations.	
10.	STORE (F1) to store the result and return to COGO Traverse Input, Input page.	
	For <Write Logfile: Yes> in COGO Configuration, Logfile page the result is written to the logfile.	
11.	Are more COGO traverse calculations to be made? <ul style="list-style-type: none"> • If yes, repeat steps 2. to 11. • If no, continue with step 12. 	
12.	SHIFT QUIT (F6) to exit COGO calculation.	

37.5.3 Traverse with Angle Right

Access

Refer to "37.2 Accessing COGO" to access **COGO Traverse Input**.

COGO

Traverse Input, Input page

12:34		COGO	
Traverse Input		X	
Input Map			
Method	:	Angle Right	
From	:	400	↕
Backsight	:	ant4	↕
Angle Right	:	69.123	g
Azimuth	:	25.229	g
HDist-Grid	:	0.000	m
Offset	:	0.000	m
		Q1 a ↑	
CALC	INV	SSHOT	LAST
SURVY	PAGE		

CALC (F1)

To calculate the COGO point.

INV (F2)

To calculate the values for the distance and the offset from two existing points. Available if **<HDist-XX:>** or **<Offset:>** is highlighted.

SSHOT (F3)

To calculate the point as a sideshot.

LAST (F4)

To select the values for the distance and the offset from previous COGO inverse calculations. Available if **<HDist-XX:>** or **<Offset:>** is highlighted.

SURVY (F5)

To manually occupy a point for the COGO calculation. Available if **<From:>** or **<Backsight:>** is highlighted.

SHIFT CONF (F2)

To configure the COGO application program.

SHIFT MODIF (F4)

To mathematically modify the values for the angle right, the distance and the offset. Available if **<Angle Right:>**, **<HDist-XX:>** or **<Offset:>** is highlighted.

Description of fields

Field	Option	Description
<Method:>	Angle Right	The direction from the known point to the COGO point is an angle.
<From:>	Choicelist	The point ID of the known point for the COGO calculation.
<Backsight:>	Choicelist	The point ID of a point used as backsight.
<Angle Right:>	User input	The angle between <Backsight:> and the new COGO point to be calculated from the point selected as <From:>. A positive value is for clockwise angles. A negative value is for counterclockwise angles.
<Azimuth:>	Output	The direction from the known point to the COGO point calculated from <Angle Right:>.
<HDist-XX:>	User input	The horizontal distance between the known point and the COGO point.
<Offset:>	User input	The offset of the COGO point from the line of direction. A positive offset is to the right, a negative offset is to the left.

Next step

The work flow is very similar to a COGO traverse calculation with azimuth/bearing. Refer to "37.5.2 Traverse with Azimuth/Bearing".

37.6

COGO Calculation - Intersections Method

37.6.1

Intersection with Bearing - Bearing

Description

The COGO intersection calculation bearing - bearing calculates the intersection point of two lines. A line is defined by a point and a direction.

Elements that must be known are

- the coordinates of two points.
- the direction from these known points to the COGO point.
- offsets if required and configured.

The coordinates of the known points

- may be taken from the active job.
- may be manually occupied during the COGO calculation.
- may be entered.

Points with full coordinate triplets and position only points can be used. Position only is calculated, height can be typed in.

Diagram

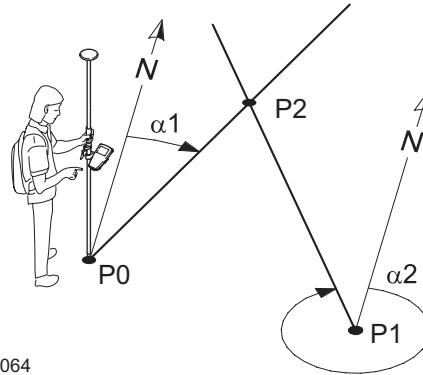

GPS12_064

Known

P0 First known point

P1 Second known point

$\alpha 1$ Direction from P0 to P2

$\alpha 2$ Direction from P1 to P2





Unknown



P2 COGO point





COGO intersection calculation with bearing - bearing step-by-step



The following table explains the most common settings. Refer to the stated chapter for more information on screens.

Step	Description	Refer to chapter
1.	Refer to "37.2 Accessing COGO" to access COGO Intersection Input .	
	COGO Intersection Input, Input page SHIFT CONF (F2) to configure the COGO application program.	37.3
2.	COGO Intersection Input, Input page <Method: Brng - Brng> <1st Point:> The point ID of the first known point for the COGO calculation.	

Step	Description	Refer to chapter
	Select the point stored in the job.	
	SURVY (F5) when <1st Point:> is highlighted. To manually occupy a point for the COGO calculation.	44.3
	For all point fields, the MapView interactive display on the Map page can be used to select the desired point.	32.5
	To type in coordinates for a known point open the choicelist when <1st Point:> is highlighted. Press NEW (F2) to create a new point.	9.3.2
3.	<p>COGO Intersection Input, Input page</p> <p><Azimuth:> The direction from the first known point to the COGO point.</p> <p><Offset:> Available for <Use Offsets: Yes> in COGO Configuration, Parameters page. The offset of the COGO point from the line of direction. A positive offset is to the right, a negative offset is to the left.</p> <p>Type in the azimuth and the offset, if required.</p>	
	<p>The values for the azimuth and the offset can be calculated from two existing points.</p> <p>INV (F2) when <Azimuth:> or <Offset:> is highlighted. To perform a COGO inverse calculation.</p> <p> Upon pressing STORE (F1) in COGO Inverse, the result from the COGO inverse calculation is copied to the field which was highlighted when INV (F2) was pressed.</p>	37.4

Step	Description	Refer to chapter
	 For <Write Logfile: Yes> in COGO Configuration, Logfile page the result of the COGO inverse calculation is written to the logfile.	
	<p>The values for the azimuth and the offset can be selected from previous COGO inverse calculations.</p> <p>LAST (F4) when <Azimuth:> or <Offset:> is highlighted. To recall previous results from COGO inverse calculations.</p> <p>Upon pressing CONT (F1) in COGO Last Inverse Calculations, the selected result is copied to the field which was highlighted when LAST (F4) was pressed.</p>	37.12
	<p>The values for the azimuth and the offset can be mathematically modified.</p> <p>SHIFT MODIF (F4) when <Azimuth:> or <Offset:> is highlighted. To add, subtract, multiply and divide values.</p>	37.13
4.	<p>COGO Intersection Input, Input page</p> <p>The procedure to input the second known point and the azimuth is identical to the procedure for the first known point. Repeat steps 2. and 3.</p>	
5.	CALC (F1) to calculate the result.	
6.	COGO Brng - Brng Results, Result page	

Step	Description	Refer to chapter
	<p><Point ID:> The identifier for the COGO point depending on the point ID template configured for <Survey Pts:> in CONFIGURE ID Templates. The point ID can be changed.</p> <p><Ortho Ht:> or <Local Ell Ht:> are input fields. The height of the first point used in the COGO calculation is suggested. A height value to be stored with the calculated point can be typed in.</p> <p>The calculated coordinates are displayed.</p> <p>Type in a point ID.</p>	19.1
	<p>COORD (F2) views other coordinate types.</p>	
	<p>STAKE (F5) to access the Stakeout application program and stake out the calculated COGO point.</p> <p>After staking, measuring and storing the COGO point COGO Brng - Brng Results, Result page is displayed.</p>	43.4
	<p>SHIFT ELL H (F2) and SHIFT ORTH (F2). Available for local coordinates. Changes between the ellipsoidal and the orthometric height.</p>	
	<p>SHIFT INDIV (F5) for an individual point ID independent of the ID template. SHIFT RUN (F5) changes back to the next ID from the configured ID template.</p>	19.1
7.	<p>PAGE (F6) changes to the Code page.</p>	
8.	<p>COGO Brng - Brng Results, Code page</p> <p><Code:>/<Point Code:> The thematical code. All codes of the job can be selected.</p>	11, 9.3.2

Step	Description	Refer to chapter
	Type in a code if required.	
9.	PAGE (F6) changes to the Plot page.	
10.	COGO Brng - Brng Results, Plot page Arrows point from the known points to the calculated COGO point.	32.6
	SHIFT QUIT (F6) does not store the COGO point and exits COGO calculation.	
11.	STORE (F1) to store the result and return to COGO Intersection Input, Input page.	
	For <Write Logfile: Yes> in COGO Configuration, Logfile page the result is written to the logfile.	
12.	Are more COGO intersection calculations to be made? <ul style="list-style-type: none"> • If yes, repeat steps 2. to 12. <Method:> in COGO Intersection Input, Input page can be changed. Refer to the relevant chapters for the other COGO intersection calculation methods. • If no, continue with step 13. 	37.6.2, 37.6.3 or 37.6.4
13.	SHIFT QUIT (F6) to exit COGO calculation.	

37.6.2**Intersection with Bearing - Distance**

Description

The COGO intersection calculation bearing - distance calculates the intersection point of a line and a circle. The line is defined by a point and a direction. The circle is defined by the centre point and the radius.

Elements that must be known are

- the coordinates of two points.
- the direction from one known point to the COGO point.
- the distance from the second known point to the COGO point.
- offsets if required and configured.

The coordinates of the known points

- may be taken from the active job.
- may be manually occupied during the COGO calculation.
- may be entered.

Points with full coordinate triplets and position only points can be used.

Diagram

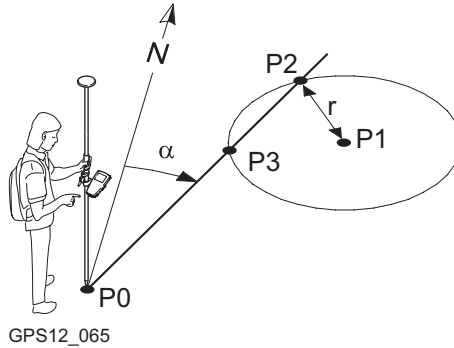

Known

P0 First known point

P1 Second known point

α Direction from P0 to P2

r Radius, as defined by the distance from P1 to P2

Unknown







P2 First COGO point



P3 Second COGO point

COGO intersection calculation with bearing - distance step-by-step

The following table explains the most common settings. Refer to the stated chapter for more information on screens.

Step	Description	
1.	<p>The procedure of a COGO intersection calculation with bearing - distance is similar to a COGO intersection calculation with bearing - bearing.</p> <p>Follow the steps 1. to 5. in paragraph "COGO intersection calculation with bearing - bearing step-by-step". The differences are:</p> <ul style="list-style-type: none"> • <Method: Brng - Dist> is to be selected in COGO Intersection Input, Input page. • For the second known point <HDist-XX:> is used instead of <Azimuth:>. The keys and advice mentioned are still valid. 	37.6.1
2.	CALC (F1) to calculate the COGO points.	

Step	Description	
	Two results are calculated.	
3.	<p>COGO Brng - Dist Results, Result1 page</p> <p><Point ID:> The identifier for the first result of the COGO point depending on the point ID template configured for <Survey Pts:> in CONFIGURE ID Templates. The point ID can be changed.</p> <p><Ortho Ht:> or <Local Ell Ht:> are input fields. When entering the Result1 page, the height of the first point used in the COGO calculation is suggested. A height value to be stored with the calculated point can be typed in.</p> <p>The calculated coordinates are displayed. Type in a point ID.</p>	19.1
	COORD (F2) views other coordinate types.	
	<p>STAKE (F5) to access the Stakeout application program and stake out the calculated COGO point.</p> <p>After staking, measuring and storing the COGO point COGO Brng - Brng Results, Result1 page is displayed.</p>	43.4
	SHIFT ELL H (F2) and SHIFT ORTH (F2) . Available for local coordinates. Changes between the ellipsoidal and the orthometric height.	
	SHIFT INDIV (F5) for an individual point ID independent of the ID template. SHIFT RUN (F5) changes back to the next ID from the configured ID template.	19.1
	PAGE (F6) changes to the Code page where a code and attributes can be selected.	11

Step	Description	
	Pressing PAGE (F6) twice changes to the Plot page. Both COGO points and known points are displayed.	32.6
	SHIFT QUIT (F6) does not store the COGO points and exits COGO calculations.	
	RSLT1 (F3) or RSLT2 (F3) to view the first and second result.	
4.	COGO Brng - Dist Results, Result1 page Is the first result to be stored? <ul style="list-style-type: none"> • If yes, STORE (F1) to store the result and activate the Result2 page. For <Write Logfile: Yes> in COGO Configuration, Logfile page the result is written to the logfile. • If no, RSLT2 (F3) to activate the Result2 page. 	
5.	COGO Brng - Dist Results, Result2 page Repeat step 3.	
6.	COGO Brng - Dist Results, Result2 page Is the second result to be stored? <ul style="list-style-type: none"> • If yes, STORE (F1) to store the result and return to COGO Intersection Input, Input page. For <Write Logfile: Yes> in COGO Configuration, Logfile page the result is written to the logfile. • If no, ESC does not store the COGO point and returns to COGO Intersection Input, Input page. 	
7.	Are more COGO intersection calculations to be done?	

Step	Description	
	<ul style="list-style-type: none">• If yes, repeat steps 1. to 7. <Method:> in COGO Intersection Input, Input page can be changed. Refer to the relevant chapters for other COGO intersection calculation method than <Method: Brng - Dist>.• If no, continue with step 8.	37.6.1, 37.6.3 or 37.6.4
8.	SHIFT QUIT (F6) exit COGO calculation.	

37.6.3

Intersection with Distance - Distance

Description

The COGO intersection calculation distance - distance calculates the intersection point of two circles. The circles are defined by the known point as the centre point and the distance from the known point to the COGO point as the radius.

Elements that must be known are

- the coordinates of two points.
- the distance from the known points to the COGO point.

The coordinates of the known points

- may be taken from the active job.
- may be manually occupied during the COGO calculation.
- may be entered.

Points with full coordinate triplets and position only points can be used.

Diagram

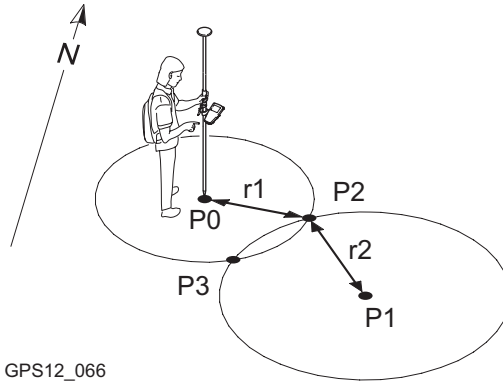

GPS12_066

Known

- P0 First known point
- P1 Second known point
- r1 Radius, as defined by the distance from P0 to P2
- r2 Radius, as defined by the distance from P1 to P2

Unknown

- P2 First COGO point
- P3 Second COGO point

COGO intersection calculation with distance - distance step-by-step

The following table explains the most common settings. Refer to the stated chapter for more information on screens.

Step	Description	Refer to chapter
1.	<p>The procedure for a COGO intersection calculation with distance - distance is very similar to a COGO intersection calculation with bearing - bearing.</p> <p>Follow the steps 1. to 5. in paragraph "COGO intersection calculation with bearing - bearing step-by-step" The differences are:</p> <ul style="list-style-type: none"> • <Method: Dist - Dist> is to be selected in COGO Intersection Input, Input page. • For both known points <HDist-XX:> is used instead of <Azimuth:>. The keys and advice mentioned are still valid. 	37.6.1

Step	Description	Refer to chapter
	<ul style="list-style-type: none"> • <Offset:> is unavailable. 	
2.	The remaining procedure is identical to a COGO intersection calculation with bearing - distance. The screen is called COGO Dist - Dist Results .	
	Follow the steps 2. to 8. in paragraph "COGO intersection calculation with bearing - distance step-by-step".	37.6.2

37.6.4**Intersection with By Points**

Description

The COGO intersection calculation by points calculates the intersection point of two lines. A line is defined by two points.

Elements that must be known are

- the coordinates of four points.
- offsets of the lines if required and configured.

The coordinates of the known points

- may be taken from the active job.
- may be manually occupied during the COGO calculation.
- may be entered.

Points with full coordinate triplets and position only points can be used.

Diagram

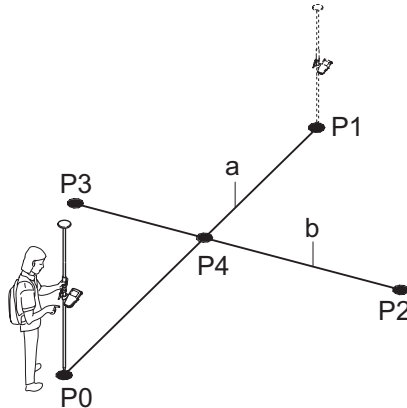

GPS12_107

Known

- P0 First known point
- P1 Second known point
- P2 Third known point
- P3 Fourth known point
- a Line from P0 to P1
- b Line from P2 to P3





Unknown





- P4 COGO point

COGO intersection calculation with by points step-by-step

The following table explains the most common settings. Refer to the stated chapter for more information on screens.

Step	Description	Refer to chapter
1.	Refer to "37.2 Accessing COGO" to access COGO Intersection Input .	
	COGO Intersection Input, Input page SHIFT CONF (F2) to configure the COGO application program.	37.3
2.	COGO Intersection Input, Input page <Method: By Points>	

Step	Description	Refer to chapter
	<p><1st Point:> The point ID of the known start point of the first line for the COGO calculation.</p> <p><2nd Point:> The point ID of the known end point of the first line for the COGO calculation.</p> <p>Select the points stored in the job.</p>	
	<p>SURVY (F5) when <1st Point:> or <2nd Point:> is highlighted. To manually occupy a point for the COGO calculation.</p>	44.3
	<p>For all point fields, the MapView interactive display on the Map page can be used to select the desired point.</p>	32.5
	<p>To type in coordinates for a known point open the choicelist when <1st Point:> or <2nd Point:> is highlighted. Press NEW (F2) to create a new point.</p>	9.3.2
3.	<p>COGO Intersection Input, Input page</p> <p><Offset:> Available for <Use Offsets: Yes> in COGO Configuration, Parameters page. The offset of the line in the direction <1st Point:> to <2nd Point:>. A positive offset is to the right, a negative offset is to the left.</p> <p>Type in the offset if required.</p>	
	<p>The value for the offset can be calculated from two existing points.</p> <p>INV (F2) when <Offset:> is highlighted. To perform a COGO inverse calculation.</p>	37.4

Step	Description	Refer to chapter
	<p> Upon pressing STORE (F1) in COGO Inverse, the result from the COGO inverse calculation is copied to the field which was highlighted when INV (F2) was pressed.</p> <p> For <Write Logfile: Yes> in COGO Configuration, Logfile page the result of the COGO inverse calculation is written to the logfile.</p>	
<p></p>	<p>The value for the offset can be selected from previous COGO inverse calculations.</p> <p>LAST (F4) when <Offset:> is highlighted. To recall previous results from COGO inverse calculations.</p> <p>Upon pressing CONT (F1) in COGO Last Inverse Calculations, the selected result is copied to the field.</p>	37.12
<p></p>	<p>The value for the offset can be mathematically modified.</p> <p>SHIFT MODIF (F4) when <Offset:> is highlighted. To add, subtract, multiply and divide values.</p>	37.13
4.	<p>COGO Intersection Input, Input page</p> <p>The procedure for the third and fourth known point and the offset is identical to the procedure for the first and second known point. Repeat steps 2. and 3.</p>	

Step	Description	Refer to chapter
5.	The remaining procedure is identical to a COGO intersection calculation with bearing - bearing. The screen is called COGO By Points Results . On the Plot page two solid lines are displayed. Follow the steps 5. to 13. in paragraph "COGO intersection calculation with bearing - bearing step-by-step".	37.6.1

37.6.5

Intersection with TPS Observation - TPS Observation

Description

The COGO intersection calculation TPS observation - TPS observation calculates the intersection point of two lines. A line is defined by a TPS station and a TPS measurement from this station.

Elements that must be known are

- the coordinates of two points.
- azimuths of the lines.

The coordinates of the known points

- must be taken from the active job.
- must be TPS station points.

The azimuths of the lines

- must be TPS measurements from the known points.

Points with full coordinate triplets and position only points can be used.

Diagram

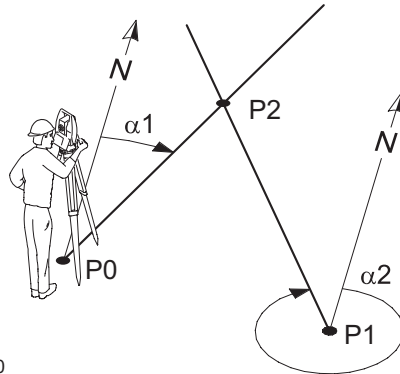

Known

- P0 First known point (TPS station)
- P1 Second known point (TPS station)
- $\alpha 1$ Direction from P0 to P2
- $\alpha 2$ Direction from P1 to P2

Unknown





- P2 COGO point

GPS12_170

COGO intersection calculation with TPS Obs - TPS Obs step-by-step

The following table explains the most common settings. Refer to the stated chapter for more information on screens.

Step	Description	Refer to chapter
1.	Refer to "37.2 Accessing COGO" to access COGO Intersection Input .	
	COGO Intersection Input, Input page SHIFT CONF (F2) to configure the COGO application program.	37.3
2.	COGO Intersection Input, Input page <Method: TPS Obs-TPS Obs> <1st TPS Stn:> The point ID of the first TPS station which is the known start point of the first line for the COGO calculation.	

Step	Description	Refer to chapter
	<p><TPS Measmnt:> The point ID of the TPS measurement which is the known end point of the first line for the COGO calculation.</p> <p><Azimuth:> The azimuth related to the known end point of the first line for the COGO calculation.</p> <p><2nd TPS Stn:> The point ID of the second TPS station which is the known start point of the second line for the COGO calculation.</p> <p><TPS Measmnt:> The point ID of the TPS measurement which is the known end point of the second line for the COGO calculation.</p> <p><Azimuth:> The azimuth related to the known end point of the second line for the COGO calculation.</p> <p>Points can only be selected from the active job.</p>	
	<p>The value for the azimuth can be calculated from two existing points. INV (F2) when <Azimuth:> is highlighted. To perform a COGO inverse calculation.</p> <p> Upon pressing STORE (F1) in COGO Inverse, the result from the COGO inverse calculation is copied to the field which was highlighted when INV (F2) was pressed.</p> <p> For <Write Logfile: Yes> in COGO Configuration, Logfile page the result of the COGO inverse calculation is written to the logfile.</p>	37.4
	<p>The value for the azimuth can be selected from previous COGO inverse calculations.</p>	37.12

Step	Description	Refer to chapter
	<p>LAST (F4) when <Azimuth:> is highlighted. To recall previous results from COGO inverse calculations.</p> <p>Upon pressing CONT (F1) in COGO Last Inverse Calculations, the selected result is copied to the field.</p>	

37.7

37.7.1

Description

COGO Calculation - Line Calculations Method

Line Calculation - Base Point

The COGO line calculation base point calculates the base point, station and offset of a point in relation to a line.

Elements that must be known are

- coordinates of two points and an offset point.

OR

- coordinates of one point and an offset point
- bearing and distance from one point

The coordinates of the known points

- may be taken from the active job.
 - may be measured during the COGO calculation.
 - may be entered.
-

Diagram

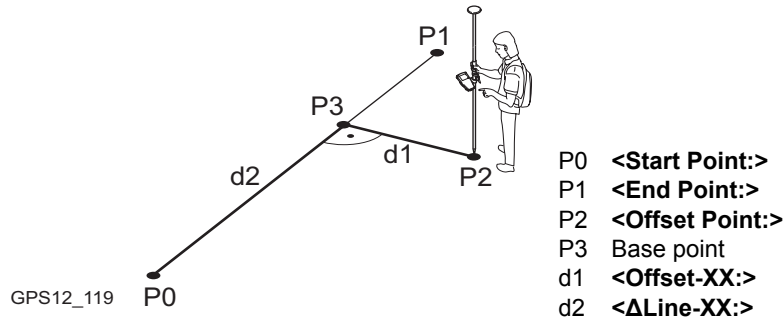

Line management is not available for COGO line calculations.

Access

Refer to "37.2 Accessing COGO" to access **COGO Line Calculations Input**.

COGO

Line Calculations Input, Input page

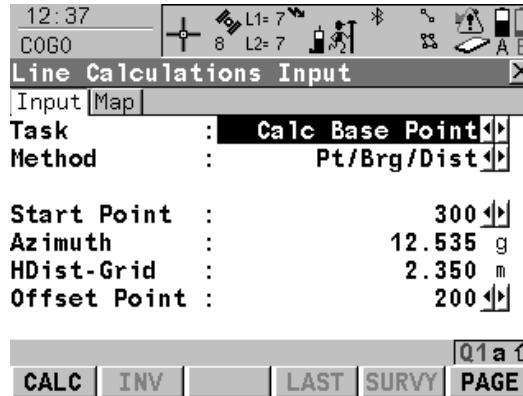

CALC (F1)

To calculate COGO point.

INV (F2)

To calculate the values for the distance and the offset from two existing points. Available if <Azimuth:> or <HDist-XX:> is highlighted.

LAST (F4)

To select the values for the distance and the offset from previous COGO inverse calculations. Available if <Azimuth:> or <HDist-XX:> is highlighted.

SURVY (F5)

To manually occupy a point for the COGO calculation. Available if **<Start Point:>** or **<End Point:>** is highlighted.

SHIFT CONF (F2)

To configure the COGO application program.

SHIFT MODIF (F4)

To mathematically modify the values. Available if **<Azimuth:>**, **< Δ Line-XX:>** or **<HDist-XX:>** is highlighted.

Description of fields

Field	Option	Description
<Task:>	Calc Base Point	Calculates the base point, the station and offset of a point in relation to a line.
	Calc Offset Point	Calculates the coordinates of a new point after input of station and offset values in relation to a line.
	Segmentation	Calculates the coordinates of new points on a line either equally spaced or with defined segments.
<Method:>	2 Points	The method by which the line will be defined. Uses two known points to define the line.
	Pt/Brg/Dist	Defines the line using a known point, a distance and an azimuth of the line.
<Start Point:>	Choicelist	The start point of the line. All points from COGO Data: Job Name can be selected.

Field	Option	Description
<End Point:>	Choicelist	Available for <Method: 2 Points>. The end point of the line. All points from COGO Data: Job Name can be selected.
<Azimuth:>	User input	Available for <Method: Pt/Brg/Dist>. The azimuth of the line.
<HDist-XX:>	User input	Available for <Method: Pt/Brg/Dist>. The horizontal distance from the start point to the end point of the line.
<ΔLine-XX:>	User input	Available for <Task: Calc Offset Point>. Horizontal distance from start point to base point.
<Offset Point:>	Choicelist	Available for <Task: Calc Base Point>. The offset point.
<Offset-XX:>	User input	Available for <Task: Calc Offset Point>. Offset from base point to offset point. Positive to the right and negative to the left of the line.

Next step

PAGE (F6) accesses **Map** page. Refer to paragraph "COGO Line Calculations Input, Map page".

COGO Line Calculations Input, Map page

The **Map** page provides an interactive display of the data. Refer to "32 MapView Interactive Display Feature" for information on the functionality and softkeys available.

Next step

IF	THEN
<Task: Calc Base Point>	CALC (F1) accesses COGO Base Point Results . Refer to paragraph "COGO XX Point Results, Result page".
<Task: Calc Offset Point>	CALC (F1) accesses COGO Offset Point Results . Refer to paragraph "COGO XX Point Results, Result page".
<Task: Segmentation>	CALC (F1) accesses COGO Define Segmentation . Refer to paragraph "37.7.3 Line Calculation - Segmentation".

COGO XX Point Results, Result page

The result screens for base point and offset point are very similar. The explanations given for the softkeys below are valid for the **Result** page.

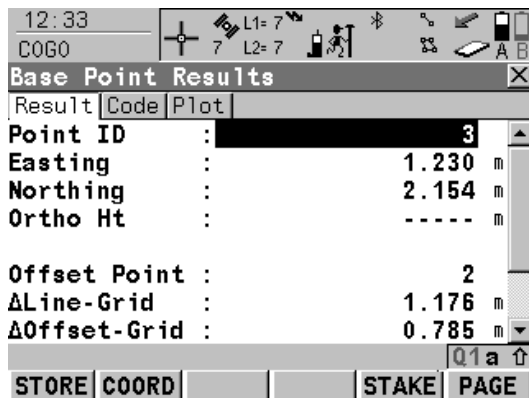

STORE (F1)

To store result and to return to **COGO Line Calculations Input**.

COORD (F2)

To view other coordinate types.

STAKE (F5)

To access the Stakeout application program and stake out the calculated COGO point.

PAGE (F6)

To change to another page on this screen.

SHIFT ELL H (F2) and SHIFT ORTH (F2)

To change between the ellipsoidal and the orthometric height.

SHIFT INDIV (F5) and SHIFT RUN (F5)

To change between entering an individual point ID different to the defined ID template and the running point ID according to the ID template. Refer to "19.1 ID Templates".

Description of fields

Field	Option	Description
<Point ID:>	User input	The identifier for the COGO point depending on the point ID template configured for <Survey Pts:> in CONFIGURE ID Templates .
<Ortho Ht:> or <Local Ell Ht:>	User input	The height of the start point of the line is suggested. A height value to be stored with the calculated point can be typed in.
<Offset Point:>	Output	Point ID of offset point. Available for <Task: Calc Base Point >.
<ΔLine-XX:>	Output	Horizontal distance from start point to base point. Available for <Task: Calc Base Point >.
<ΔOffset-XX:>	Output	Offset from base point to offset point. Positive to the right and negative to the left of the line. Available for <Task: Calc Base Point >.
<Line Length:>	Output	Length of line from start point to end point.
<Line Brng:>	Output	Bearing of line from start point to end point.
<Offs Pt Brng:>	Output	Bearing of offset point from base point to offset point.

**COGO
XX Point Results,
Code page**

Next step

PAGE (F6) changes to the **Code** page.

The functionality of the **Code** page is similar to **COGO Traverse Result, Code** page.

Next step

PAGE (F6) changes to the **Plot** page.

The functionality of the **Plot** page is similar to **COGO Traverse Results, Plot** page.

**COGO
XX Point Results,
Plot page**

Next step

STORE (F1) stores the result and accesses **COGO Line Calculations Input, Input** page.

37.7.2

Line Calculation - Offset Point

Description

The COGO line calculation offset point calculates the coordinates of a new point after input of station and offset values in relation to a line.

Elements that must be known are

- coordinates of two points.
- offsets.

OR

- coordinates of one point.
- bearing and distance from one point.
- offsets.

The coordinates of the known points

- may be taken from the active job.
- may be measured during the COGO calculation.
- may be entered.



**COGO line calculation
offset point step-by-
step**

Line management is not available for COGO line calculations.

The following table explains the most common settings. Refer to the stated chapter for more information on screens.

Step	Description	Refer to chapter
1.	Refer to "37.2 Accessing COGO" to access COGO Line Calculations Input .	

Step	Description	Refer to chapter
	COGO Line Calculations Input, Input page SHIFT CONF (F2) to configure the COGO application program.	37.3
2.	COGO Line Calculations Input, Input page <Task: Calc Offset Point>	37.7.1
3.	CALC (F1) calculates the results.	
4.	COGO Offset Point Results, Result page STORE (F1) stores the results.	37.7.1

37.7.3

Line Calculation - Segmentation

Description

The COGO line calculation segmentation calculates the coordinates of new points on a line.

Elements that must be known are

- coordinates of the start and the end point of the line

OR

- a bearing and distance from a known point that define the line

AND EITHER

- the number of segments dividing the line

OR

- a segment length for the line.

The coordinates of the known points

- may be taken from the active job.
- may be measured during the COGO calculation.
- may be entered.

Diagram

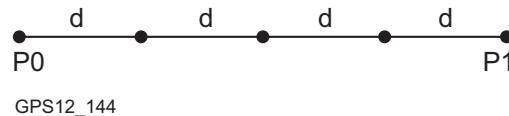

Line divided by **<Method: No. of Segments>**

P0 **<Start Point:>**

P1 **<End Point:>**

d Equally spaced segments result from dividing a line by a certain number of points.

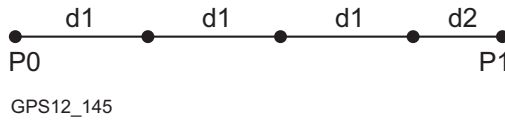

Line divided by **<Method: Segment Length>**

P0 **<Start Point:>**

P1 **<End Point:>**

d1 **<Seg Length:>**

d2 Remaining segment

COGO line calculation segmentation step-by-step

The following table explains the most common settings. Refer to the stated chapter for more information on screens.

Step	Description	Refer to chapter
1.	Refer to "37.2 Accessing COGO" to access COGO Line Calculation Input .	
	COGO Line Calculations Input, Input page SHIFT CONF (F2) to configure the COGO application program.	37.3
2.	COGO Line Calculations Input, Input page <Task: Segmentation>	37.7.1
3.	CALC (F1) to access COGO Define Segmentation .	
4.	COGO Define Segmentation <Method:> How the line is to be divided. Refer to paragraph "Diagram". Depending on the selection, the following fields are user input or output fields. <Line Length:> Calculated line length between the selected <Start Point:> and <End Point:> .	

Step	Description	Refer to chapter
	<p><No. of Segs:> For <Method: No. of Segments> type in the number of segments for the line. For <Method: Segment Length> type in the segment length for the line. A remaining segment may result from this method.</p> <p><Seg Length:> For <Method: No. of Segments> this is the calculated length of each segment. For <Method: Segment Length> type in the required segment length.</p> <p><Last Seg Lgth:> Available for <Method: Segment Length>. The length of the remaining segment.</p> <p><Start PtID:> The point ID to be assigned to the first new point on the line. The selected point ID templates from CONFIGURE ID Templates are not applied.</p> <p><PtID Inc:> <Start PtID:> is incremented numerically for the second, third, etc. point on the line.</p>	
5.	CALC (F1) to access COGO Segmentation Results .	
	The coordinates of the new points are calculated. The heights are computed along the line assuming a linear slope between <Start Point:> and <End Point:> .	
6.	<p>COGO Segmentation Results, Result page</p> <p><Number of Segments:> Describes the number of resulting segments for the line including the remaining segment, if it applies.</p>	

Step	Description	Refer to chapter
	< Last Segment Lgth: > Available for < Method: Segment Length >. The length of the remaining segment.	
	STAKE (F5) to access the Stakeout application program and stake out the calculated COGO point. SHIFT QUIT (F6) or ESC return to COGO Segmentation Results, Result page.	
7.	PAGE (F1) to access COGO Segmentation Results, Plot page The known points defining the line and those created on the line are shown in black.	32.6
8.	CONT (F1) returns to COGO Line Calculations Input .	

37.8

COGO Calculation - Arc Calculations Method

37.8.1

Arc Calculation - Arc Center

Description

The COGO arc calculation arc center calculates the coordinates of the centre of the arc.

Elements that must be known are

- coordinates of three points

OR

- coordinates of two points
- radius to the two points

The coordinates of the known points

- may be taken from the active job.
- may be measured during the COGO calculation.
- may be entered.

Diagram

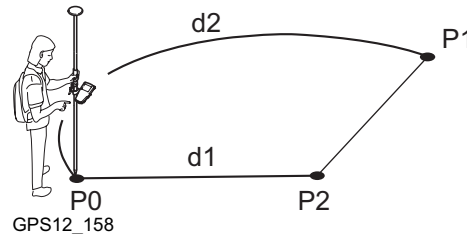

P0 <Start Point:>

P1 <End Point:>

P2 Arc center

d1 <Arc Radius:>

d2 <Arc Length:>



Arc management is not available for COGO arc calculations.

Access

Refer to "37.2 Accessing COGO" to access **COGO Arc Calculations Input**.

COGO Arc Calculations Input, Input page

The softkeys are similar to line calculation. Refer to "37.7.1 Line Calculation - Base Point" for information on softkeys.

Description of fields

Field	Option	Description
<Task:>	Calc Arc Center	Calculates the coordinates of the centre of the arc.
	Calc Offset Point	Calculates the coordinates of a new point after input of station and offset values in relation to an arc.
	Calc Base Point	Calculates the base point, the station and offset of a point in relation to an arc.
	Segmentation	Calculates the coordinates of new points on an arc either equally spaced, in a defined interval or in a defined angle.
<Method:>	3 Points	The method by which the arc will be defined. Uses three known points to define the arc.
	2 Points/Radius	Defines the arc using two known points and a radius of the arc.
	2 Tgnts/Radius	Defines the arc using two tangents and a radius of the arc.
	2 Tgnts/Arc Lngt	Defines the arc using two tangents and the length of the arc.

Field	Option	Description
	2 Tgnts/Chrd Lngt	Defines the arc using two tangents and the chord of the arc.
<Start Point:>	Choicelist	The start point of the arc. All points from COGO Data: Job Name can be selected. Available for <Method: 3 Points> and <Method: 2 Points/Radius> .
<Second Point:>	Choicelist	All points from COGO Data: Job Name can be selected. Available for <Method: 3 Points> . The second point of the arc.
<End Point:>	Choicelist	The end point of the arc. All points from COGO Data: Job Name can be selected. Available for <Method: 3 Points> and <Method: 2 Points/Radius> .
<Point 1:>	Choicelist	A point on the first tangent. Available for <Method: 2 Tgnts/Radius> , <Method: 2 Tgnts/Arc Lngt> and <Method: 2 Tgnts/Chrd Lngt> .
<PI Point:>	Choicelist	The point of intersection of the two tangents. Available for <Method: 2 Tgnts/Radius> , <Method: 2 Tgnts/Arc Lngt> and <Method: 2 Tgnts/Chrd Lngt> .
<Point 2:>	Choicelist	A point on the second tangent. Available for <Method: 2 Tgnts/Radius> , <Method: 2 Tgnts/Arc Lngt> and <Method: 2 Tgnts/Chrd Lngt> .
<Radius:>	User input	The radius of the arc. Available for <Method: 2 Points/Radius> and <Method: 2 Tgnts/Radius> .

Field	Option	Description
<Arc Length:>	User input	The length of the arc. Available for <Method: 2 Tgnts/Arc Lngt>.
<Chord Length:>	User input	The length of the chord. Available for <Method: 2 Tgnts/Chrd Lngt>.
< Δ ArcDist-XX:>	User input	Horizontal distance along the arc from start point to base point. Available for <Task: Calc Offset Point>.
< Δ Offset-XX:>	User input	Offset from base point to offset point. Positive to the right and negative to the left of the arc. Available for <Task: Calc Offset Point>.
<Offset Point:>	Choicelist	The offset point. Available for <Task: Calc Base Point>.

Next step

IF	THEN
<Task: Calc Arc Center>	CALC (F1) accesses COGO Center of Arc Results . Refer to paragraph "COGO XX Results, Result page".
<Task: Calc Offset Point>	CALC (F1) accesses COGO Offset Point Results . Refer to paragraph "COGO XX Results, Result page".
<Task: Calc Base Point>	CALC (F1) accesses COGO Base Point Results . Refer to paragraph "COGO XX Results, Result page".
<Task: Segmentation>	CALC (F1) accesses COGO Define Segmentation . Refer to "37.8.4 Arc Calculation - Segmentation".

**COGO
XX Results,
Result page**

Refer to paragraph "37.7.1 Line Calculation - Base Point" for information on softkeys.

Description of fields

Field	Option	Description
<Point ID:>	User input	The identifier for the COGO point depending on the point ID template configured for <Survey Pts:> in CONFIGURE ID Templates .
<Ortho Ht:> or <Local Ell Ht:>	User input	The height of the start point of the arc is suggested. A height value to be stored with the calculated point can be typed in.
<Arc Radius:>	Output	Computed radius of arc.
<Arc Length:>	Output	Computed length of arc.
<Offs Pt Brng:>	Output	Available for <Task: Calc Offset Point >. Bearing of offset point from base point to offset point.
<Offset Point:>	Output	Available for <Task: Calc Base Point >. Point ID of offset point.
< Δ ArcDist- XX:>	Output	Available for <Task: Calc Base Point >. Horizontal distance along the arc from start point to base point.
< Δ Offset-XX:>	Output	Available for <Task: Calc Base Point >. Offset from base point to offset point. Positive to the right and negative to the left of the line.

**COGO
XX Results,
Code page**

Next step

PAGE (F6) changes to the **Code** page.

The functionality of the **Code** page is similar to **COGO Traverse Results, Code** page.

Next step

PAGE (F6) changes to the **Plot** page.

The functionality of the **Plot** page is similar to **COGO Traverse Results, Plot** page.

**COGO
XX Results,
Plot page**

Next step

STORE (F1) stores the result and accesses **COGO Arc Calculations Input, Input** page.

37.8.2**Arc Calculation - Base Point**

Description

The COGO arc calculation base point calculates the coordinates of the base point, station and offset of a point in relation to an arc.

Elements that must be known are

- coordinates of three points
- coordinates of an offset point

OR

- coordinates of two points
- radius to the two points
- coordinates of an offset point

The coordinates of the known points

- may be taken from the active job.
 - may be measured during the COGO calculation.
 - may be entered.
-

Diagram

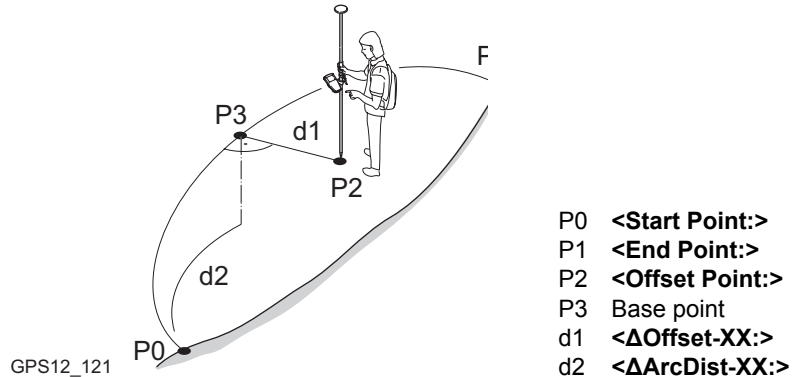

COGO arc calculation base point step-by-step

Arc management is not available for COGO arc calculations.

The following table explains the most common settings. Refer to the stated chapter for more information on screens.

Step	Description	Refer to chapter
1.	Refer to "37.2 Accessing COGO" to access COGO Arc Calculations Input .	
	COGO Arc Calculations Input, Input page SHIFT CONF (F2) to configure the COGO application program.	37.3
2.	COGO Arc Calculations Input, Input page. <Task: Calc Base Point>	37.8.1

Step	Description	Refer to chapter
3.	CALC (F1) calculates the results.	
4.	COGO Base Point Results, Result page STORE (F1) stores the results.	37.8.1

37.8.3

Arc Calculation - Offset Point

Description

The COGO arc calculation offset point calculates the coordinates of a new point after input of arc and offset values in relation to an arc.

Elements that must be known are

- coordinates of three points.
- offsets.

OR

- coordinates of two points.
- radius to the two points.
- offsets.

The coordinates of the known points

- may be taken from the active job.
- may be measured during the COGO calculation.
- may be entered.



COGO arc calculation offset point step-by- step

Arc management is not available for COGO arc calculations.

The following table explains the most common settings. Refer to the stated chapter for more information on screens.

Step	Description	Refer to chapter
1.	Refer to "37.2 Accessing COGO" to access COGO Arc Calculations Input .	

Step	Description	Refer to chapter
	COGO Arc Calculations Input, Input page. SHIFT CONF (F2) to configure the COGO application program.	37.3
2.	COGO Arc Calculations Input, Input page. <Task: Calc Offset Point>	37.8.1
3.	CALC (F1) calculates the results.	
4.	COGO Offset Point Results, Result page STORE (F1) stores the results.	37.8.1

37.8.4



Exceptions to line calculation segmentation

Arc Calculation - Segmentation

The COGO arc calculation segmentation and the functionality of all screens and fields are similar to those for COGO line calculation segmentation. Refer to "37.7.3 Line Calculation - Segmentation".

New field and option in COGO Define Segmentation

Field	Option	Description
<Method:>	Delta Angle	To divide the arc by an angular value.
<Delta Angle:>	User input	The angular value by which new points will be defined on the arc.

37.9**COGO Calculation - Shift, Rotate & Scale (Manual) Method**

Description

The COGO calculation shift, rotate & scale (manual) applies shifts and/or rotation and/or scale to one or several known points. The values for shifts and/or rotation and/or scale are typed in manually.

Elements that must be known are

- the coordinates of the points to be shifted, rotated and/or scaled. They must be stored in the active job.
- the shift values. They can be defined as the direction of Easting, Northing and Height or as an azimuth and a grid distance or as shift from one point to another.
- the rotation value. It can be defined by a point as rotation center plus a rotation or by an existing and new azimuth.
- the scale. It is only applied to the position.

Points with full coordinate triplets, position only points and height only points can be used.

Diagram

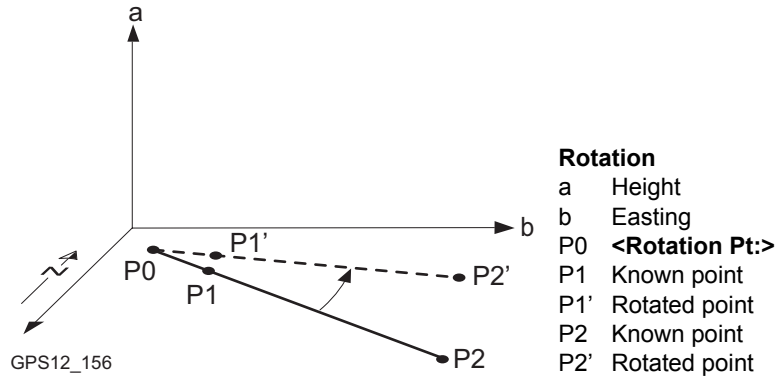
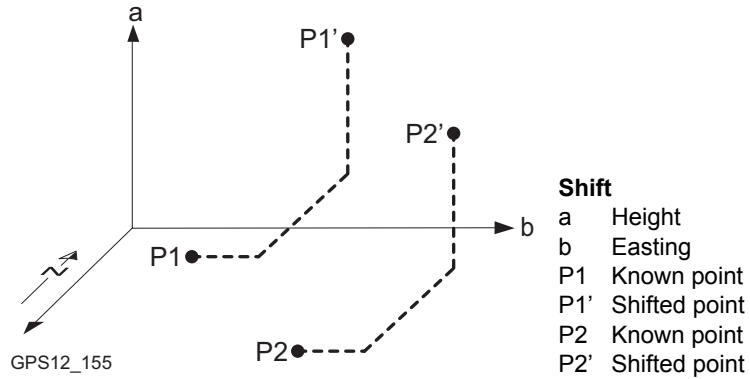

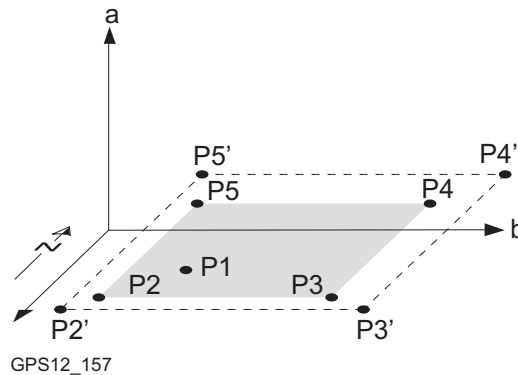
**Scale**

a Height

b Easting

P1 **<Rotation Pt.>**, can be held fixed, all other points are then scaled from here

P2 Known point

P2' Scaled point

P3 Known point

P3' Scaled point

P4 Known point

P4' Scaled point

P5 Known point

P5' Scaled point

Access

Refer to "37.2 Accessing COGO" to access **COGO Shift, Rotate & Scale**.

COGO Shift, Rotate & Scale, Points page

Listed are points which have been selected for shifting, rotating and/or scaling.

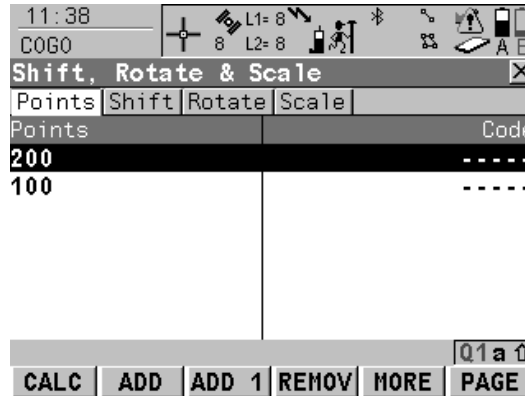

CALC (F1)

To perform the shift, rotation and scale calculation and to continue with the subsequent screen. Calculated COGO points are not yet stored.

ADD (F2)

To add all points from the active job to the list. Accesses **COGO Data: Job Name**. Selected sort and filter settings apply. **CONT (F1)** adds all displayed points to the list in **COGO Shift, Rotate & Scale** and returns to that screen.

ADD 1 (F3)

To add one point from the active job to the list. Accesses **COGO Data: Job Name**. Selected sort and filter settings apply. **CONT (F1)** adds the currently highlighted point to the list in **COGO Shift, Rotate & Scale** and returns to that screen.

REMOV (F4)

To remove the highlighted point from the list. The point itself is not deleted.

MORE (F5)

To display information about the codes if stored with any point, the time and the date of when the point was stored and the 3D coordinate quality and the class.

PAGE (F6)

To change to another page on this screen.

SHIFT REM A (F4)

To remove all points from the list. The points itself are not deleted.

SHIFT RANGE (F5)

To define a range of points from the active job to be added to the list. Refer to paragraph "COGO Select Points by Range".

Next step

IF	THEN
all points from COGO Data: Job Name are to be added	ADD (F2) .
one point from COGO Data: Job Name is to be added	ADD 1 (F3) .
a range of points from COGO Data: Job Name is to be added	SHIFT RANGE (F5) accesses COGO Select Points by Range . Refer to paragraph "COGO Select Points by Range".
all points are added	PAGE (F1) accesses COGO Shift, Rotate & Scale, Shift page. Refer to paragraph "COGO Shift, Rotate & Scale, Shift page".

COGO Select Points by Range

11:40
COGO
Select Points by Range
From Pt ID : 1
To Pt ID : 50

CONT (F1)

To add the points within the selected range to the list in **COGO Shift, Rotate & Scale, Points** page and to return to the screen from where this screen was accessed.

NEXT (F3)

To add the points within the selected range to the list in **COGO Shift, Rotate & Scale, Points** page without quitting this screen. Another range of point ID's can be selected.

CONT NEXT Q1 a ↑

Description of fields

Field	Option	Description
<From Pt ID:> and <To Pt ID:>	User input	<ul style="list-style-type: none"> Numeric point ID's in both fields: Points with numeric point ID's falling within the range are selected. Example: <From Pt ID: 1>, <To Pt ID: 50> Selected are point ID's 1, 2, 3, 4, 5, 6, 7, 8, 9, 10.... 49, 50 as well as 001, 01, 0000045, ... Not selected are point ID's 100,200,300, ...

Field	Option	Description
		<ul style="list-style-type: none"> Alphanumeric point ID's in both fields: The left most character of both entries is used as the basis for the range. The standard ASCII numerical range is used. Points with alphanumeric point ID's falling within the range are selected. Example: <From Pt ID: a9>, <To Pt ID: c200> Selected are point ID's a, b, c, aa, bb, cc, a1, b2, c3, c4, c5, a610, ... Not selected are point ID's d100, e, 200, 300, tzz ...

Next step

Step	Description
1.	CONT (F1) adds all points within the range to the list in COGO Shift, Rotate & Scale and returns to the screen from where this screen was accessed.
2.	PAGE (F6) accesses COGO Shift, Rotate & Scale, Shift page. Refer to "COGO Shift, Rotate & Scale, Shift page".

COGO

Shift, Rotate & Scale, Shift page

11:41
COGO
Shift, Rotate & Scale
Points Shift Rotate Scale
Method : Enter $\Delta E, \Delta N, \Delta Ht$
 Δ Easting : 20.000 m
 Δ Northing : 10.000 m
 Δ Height : 3.000 m
Q1 a ↑
CALC INV LAST SURVY PAGE

CALC (F1)

To perform the shift, rotation and scale calculation and to continue with the subsequent screen. Calculated COGO points are not yet stored.

INV (F2)

To calculate the amount of shift in Easting, Northing and height from two existing points. Available if **< Δ Easting:>**, **< Δ Northing:>** or **< Δ Height:>** is highlighted.

LAST (F4)

To select the value for the shift from previous COGO inverse calculations. Available if **< Δ Easting:>**, **< Δ Northing:>** or **< Δ Height:>** is highlighted.

SURVY (F5)

To manually occupy a point for the COGO calculation. Available for **<Method: Use 2 Points>** if **<From:>** or **<To:>** is highlighted.

PAGE (F6)

To change to another page on this screen.

SHIFT CONF (F2)

To configure the COGO application program. Accesses **COGO Configuration**. Refer to "37.3 Configuring COGO".

SHIFT MODIF (F4)

To mathematically modify the values. Available if **<Δ Easting:>**, **<Δ Northing:>** or **<Δ Height:>** is highlighted.

Description of fields

Field	Option	Description
<Method:>	<p>Enter ΔE,ΔN,ΔHt</p> <p>Enter Bng,Dst,Ht</p> <p>Use 2 Points</p>	<p>The method by which the shift in Δ Easting, Δ Northing and Δ Height will be determined.</p> <p>Defines the shift using coordinate differences.</p> <p>Defines the shift using an azimuth, a distance and a height difference.</p> <p>Computes the shift from the coordinate differences between two known points.</p>
<From:>	Choicelist	Available for <Method: Use 2 Points> . The point ID of the first known point for calculating the shift.
<To:>	Choicelist	Available for <Method: Use 2 Points> . The point ID of the second known point for calculating the shift.
<Azimuth:>	User input	Available for <Method: Enter Bng,Dst,Ht> . The azimuth defines the direction of the shift.
<HDist-XX:>	User input	Available for <Method: Enter Bng,Dst,Ht> . The amount of shift from the original point to the calculated COGO points.
<Δ Easting:>	User input or output	The amount of shift in East direction.

Field	Option	Description
<Δ Northing:>	User input or output	The amount of shift in North direction.
<Δ Height:>	User input or output	The amount of shift in height.

Next step

PAGE (F6) accesses **COGO Shift, Rotate & Scale, Rotate** page. Refer to "COGO Shift, Rotate & Scale, Rotate page".

COGO Shift, Rotate & Scale, Rotate page

The softkeys are the same as on the Shift page. Refer to paragraph "COGO Shift, Rotate & Scale, Shift page" for information on the keys.

Description of fields

Field	Option	Description
<Method:>	User Entered	The method by which the rotation angle will be determined.
	Computed	The rotation can be manually typed in. The rotation will be calculated as <New Azimuth:> minus <Existing Az:> .
<Rotation Pt:>	Choicelist	The point around which all points will be rotated.
<Existing Az:>	User input	Available for <Method: Computed> . A known direction before rotating.
<New Azimuth:>	User input	Available for <Method: Computed> . A known direction after rotating.

Field	Option	Description
<Rotation:>	User input or output	The amount by which the points will be rotated.

Next step

PAGE (F6) accesses **COGO Shift, Rotate & Scale, Scale** page. Refer to "COGO Shift, Rotate & Scale, Scale page".

COGO Shift, Rotate & Scale, Scale page

The softkeys are the same as on the Shift page. Refer to paragraph "COGO Shift, Rotate & Scale, Shift page" for information on the keys.

Description of fields

Field	Option	Description
<Method:>	User Entered	The method by which the scale factor will be determined. The scale factor can be manually typed in.
	Computed	The scale factor will be calculated as <New Dist:> divided by <Existing Dist:>.
<Existing Dist:>	User input	Available for <Method: Computed>. A known distance before scaling. This value is used for calculating the scale factor.
<New Dist:>	User input	Available for <Method: Computed>. A known distance after scaling. This value is used for calculating the scale factor.
<Scale:>	User input or output	The scale factor used in the calculation.

Field	Option	Description
<Scale From Pt:>	No	Scaling is performed by multiplying the original coordinates of the points by <Scale:>.
	Yes	<Scale:> is applied to the coordinate difference of all points relative to <Rotation Pt:> selected on the Rotation page. The coordinates of <Rotation Pt:> will not change.

Next step

CALC (F1) performs the shift, rotation and scale calculation and accesses **COGO Shift, Rotate & Scale Store**.

COGO
Shift, Rotate & Scale
Store,
General page

12:37

COGO

Shift, Rotate & Scale Store

General Summary Plot

Pts Selected : 11

Store Job : Job1

Add Identifier: Yes

Identifier : COGO

Prefix/Suffix: Prefix

STORE PAGE

STORE (F1)

To store the results and continue with the next subsequent screen.

PAGE (F6)

To change to another page on this screen.

Description of fields

Field	Option	Description
<Pts Selected:>	Output	The number of selected points having been shifted, rotated and/or scaled.
<Store Job:>	Choicelist	The calculated COGO points will be stored in this job. All jobs from Main Menu: Manage...Jobs can be selected. The original points are not copied to this job.
<Add Identifier:>	Yes or No	Activates the use of identifiers for the point ID's of the calculated COGO points.
<Identifier:>	User input	The identifier with up to four characters is added in front of or at the end of the ID of the calculated COGO points.
<Prefix/Suffix:>	Prefix Suffix	Adds the setting for <Identifier:> in front of the original point ID's. Adds the setting for <Identifier:> at the end of the original point ID's.

Next step

IF	THEN
the used parameters are to be viewed	PAGE (F6) accesses COGO Shift, Rotate & Scale Store, Summary page.

IF	THEN
the calculated COGO points are to be viewed graphically	PAGE (F6) accesses COGO Shift, Rotate & Scale Store, Plot page. Original points are displayed in grey, calculated COGO points are displayed in black.
the calculated COGO points are to be stored	STORE (F1) accesses COGO Shift, Rotate & Scale Results, Result page. Refer to paragraph "COGO Shift, Rotate & Scale Results Result page".

**COGO
Shift, Rotate & Scale
Results
Result page**

Description of fields

Field	Option	Description
<No. of New Pts:>	Output	Number of new points created.
<No. of Skipped Pts>	Output	Number of points which were skipped either due to not being able to convert coordinates or points with identical point ID's already existed in <Store Job:>.

Next step

IF	THEN
the stored COGO points are to be viewed graphically	PAGE (F6) accesses COGO Shift, Rotate & Scale Results, Plot page. Original points are displayed in grey, calculated COGO points are displayed in black.
more points are to be shifted, rotated and/or scaled	CONT (F1) returns to COGO Shift, Rotate & Scale .
COGO is to be ended	SHIFT QUIT (F6) .

37.10

COGO Calculation - Shift, Rotate & Scale (Match Pts) Method

Description

The COGO calculation shift, rotate & scale (match pts) applies shifts and/or rotation and/or scale to one or several known points. The shifts and/or rotation and/or scale are calculated from selected points using a 2D Helmert transformation.

Elements that must be known are

- the coordinates of at least two matching points for the calculation of the shifts and/or rotation and/or scale.
- the coordinates of the points to be shifted, rotated and/or scaled. They must be stored in the active job.
- the shift values. They can be defined as the direction of Easting, Northing and Height or as an azimuth and a grid distance or as shift from one point to another.
- the rotation value. It can be defined by a point as rotation center plus a rotation or by an existing and new azimuth.
- the scale. It is only applied to the position.

Points with full coordinate triplets, position only points and height only points can be used.

Computation of shift, rotation and scale values

The number of pairs of points matched determines whether the shift, rotation and scale values are computed.

Number of pairs of points matched	Shift East	Shift North	Shift Height	Rotation	Scale
1	x	x	x	-	-
> 1	x	x	x	x	x

Access

Refer to "37.2 Accessing COGO" to access **COGO Match Common Points (n)**.

COGO Match Common Points (n)

This screen provides a list of points chosen from the active job. The points are used for the determination of the 2D Helmert transformation. The number of points matched is indicated in the title, for example **COGO Match Common Points (3)**. Unless there is no pair of matching points in the list all softkeys are available. Refer to paragraph "Match points step-by-step" for information on how to match points.

Source Pt	Target Pt	Match
333	101	P & H
400	ant4	P & H
10	11	P & H

CALC NEW EDIT DEL MATCH RESID

CALC (F1)

To confirm the selections, compute the transformation and continue with the subsequent screen.

NEW (F2)

To match a new pair of points. This pair is added to the list. A new point can be manually occupied. Refer to paragraph "Match points step-by-step".

EDIT (F3)

To edit the highlighted pair of matched points.

DEL (F4)

To delete the highlighted pair of matched points from the list.

MATCH (F5)

To change the type of match for a highlighted pair of matched points. Refer to "Description of columns".

RESID (F6)

To display a list of the matched points used in the transformation calculation and their associated residuals. Refer to paragraph "Fix parameters".

SHIFT PARAM (F5)

To define the parameters to be used in the 2D transformation.

Description of columns

Column	Description
Source Pt	The point ID of the points of origin for the calculation of the shifts and/or rotation and/or scale.
Target Pt	The point ID of the target points for the calculation of the shifts and/or rotation and/or scale.
Match	<p>The type of match to be made between the points. This information is used in the transformation calculation. Position & Height, Position only, Height only or None.</p> <p>None removes matched common points from the transformation calculation but does not delete them from the list. This can be used to help improve residuals.</p>

Next step

IF	THEN
the transformation is to be computed	CALC (F1) . The calculated shift, rotation and scale values are displayed in COGO Shift, Rotate & Scale . They cannot be edited. The remaining functionality of the calculation is very similar to COGO calculation shift, rotate & scale (manual). Refer to "37.9 COGO Calculation - Shift, Rotate & Scale (Manual) Method".
a pair of points is to be matched or edited	NEW (F2) or EDIT (F3) . Refer to paragraph "Match points step-by-step".
parameters for the transformation are to be fixed	SHIFT PARAM (F5) . Refer to paragraph "Fix parameters".

Match points step-by-step

Before calculating a transformation, it must be defined which points are to be matched. Matching new points and editing matched points is very similar.

Step	Description
1.	Refer to "37.2 Accessing COGO" to access COGO Match Common Points .
2.	NEW (F2) or EDIT (F3)
3.	<p>COGO Choose Matching Points or COGO Edit Matching Points</p> <p><Source Pt:> A point of origin for the calculation of the shifts and/or rotation and/or scale.</p> <p><Target Pt:> A target point for the calculation of the shifts and/or rotation and/or scale.</p>

Step	Description
	<p><Match Type:> The type of match to be made between the points selected in <Source Pt:> and <Target Pt:>. Position & Height, Position Only, Height Only or None.</p> <p>Select the points to be matched.</p>
	SURVY (F5) . To manually occupy a point and store it in the active job.
4.	CONT (F1) returns to COGO Match Common Points (n) and adds a new pair of matched points to the matched points list.

Fix parameters

The settings on this screen define the parameters to be used in the transformation.

IF the value for a field is	THEN the value for this parameter will be
-----	calculated.
any number	fixed to that value.

Description of fields

Field	Option	Description
<Δ Easting:>	User input	Shift in Easting direction.
<Δ Northing:>	User input	Shift in Northing direction.
<Δ Height:>	User input	Shift in Height direction.
<Rotation:>	User input	Rotation around the X axis.
<Scale:>	User input	Scale factor.

Next step

IF	AND	THEN
a field displays -----	the parameter needs to be fixed to a value	highlight the field. Enter the value of the parameter. FIX (F4).
a field displays a value	the parameter needs to be calcu- lated	highlight the field. ADJST (F4).
all parameters are configured	-	CONT (F1) to return to COGO Match Common Points (n).

37.11

COGO Calculation - Area Division

37.11.1

Overview

Description

The COGO calculation area division divides an area by a defined line, by percentage or by the size of a subarea.

The area division methods are listed in the table below. Elements that must be known for the calculation depend on the area division method. At least three points are required to form an area.

Divide by	Using		Elements required
Defined line	Parallel line	Through a point	<ul style="list-style-type: none"> Two points defining the line One point on the dividing line
		By a distance	<ul style="list-style-type: none"> Two points defining the line Distance
	Perpendicular line	Through a point	<ul style="list-style-type: none"> Two points defining the line One point on the dividing line
		By a distance	<ul style="list-style-type: none"> Two points defining the line Distance
Percentage	Parallel line	-	<ul style="list-style-type: none"> Size of new area in percentage Two points defining the line
	Perpendicular line	-	<ul style="list-style-type: none"> Size of new area in percentage Two points defining the line

Divide by	Using		Elements required
	Swing line	Rotation point	<ul style="list-style-type: none"> • Size of new area in percentage • Rotation point of the swing line
Area	Parallel line	-	<ul style="list-style-type: none"> • Size of new area • Two points defining the line
	Perpendicular line	-	<ul style="list-style-type: none"> • Size of new area • Two points defining the line
	Swing line	Rotation point	<ul style="list-style-type: none"> • Size of new area • Rotation point of the swing line

The coordinates of the known points

- may be taken from the active job.
- may be measured during the COGO calculation.
- may be entered.

Diagram

The diagrams show the area division methods. Some diagrams apply to several area division methods.

Area division method	<Divide:>	<Using:>	<Shift:>
1.	By Defined Line	Parallel Line	By Distance
2.	By Percentage	Parallel Line	-
3.	By Area	Parallel Line	-

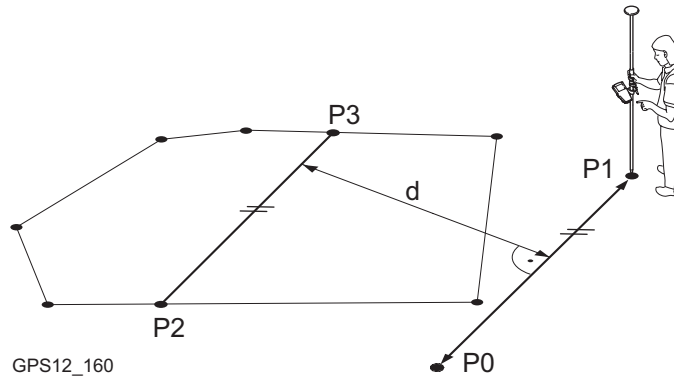

GPS12_160

- P0 **<Point A:>** of defined line
- P1 **<Point B:>** of defined line
- P2 First new COGO point
- P3 Second new COGO point
- d **<HDist-XX:>**

Area division method	<Divide:>	<Using:>	<Shift:>
1.	By Defined Line	Perpendic Line	By Distance
2.	By Percentage	Perpendic Line	-
3.	By Area	Perpendic Line	-

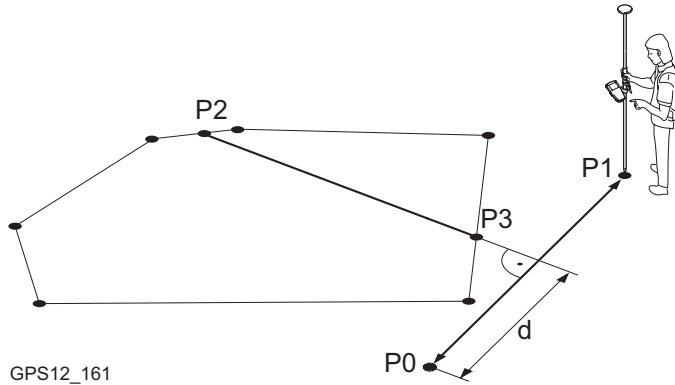

- P0 **<Point A:>** of defined line
- P1 **<Point B:>** of defined line
- P2 First new COGO point
- P3 Second new COGO point
- d **<HDist-XX:>**

Area division method	<Divide:>	<Using:>	<Shift:>
1.	By Defined Line	Parallel Line	Through Point

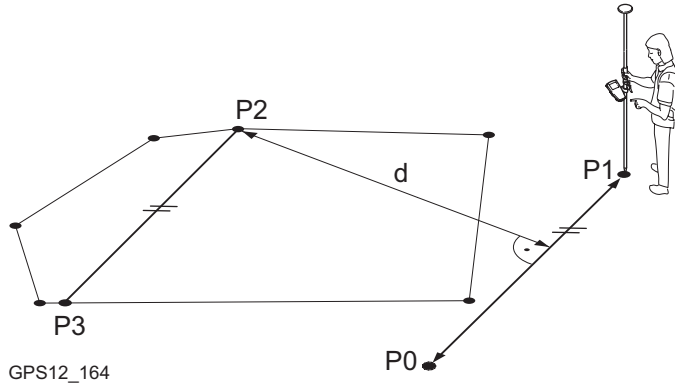

- P0 <Point A:> of defined line
- P1 <Point B:> of defined line
- P2 <Through Point:>; in this case it is a known point of the existing border
- P3 New COGO point
- d <HDist-XX:>

Area division method	<Divide:>	<Using:>	<Shift:>
1.	By Defined Line	Perpendic Line	Through Point

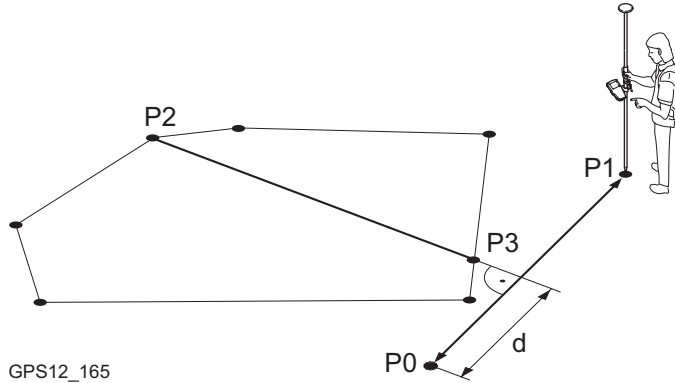

- P0 **<Point A:>** of defined line
- P1 **<Point B:>** of defined line
- P2 **<Through Point:>**; in this case it is a known point of the existing border
- P3 New COGO point
- d **<HDist-XX:>**

Area division method	<Divide:>	<Using:>	<Shift:>
1.	By Percentage	Swing Line	-
2.	By Area	Swing Line	-

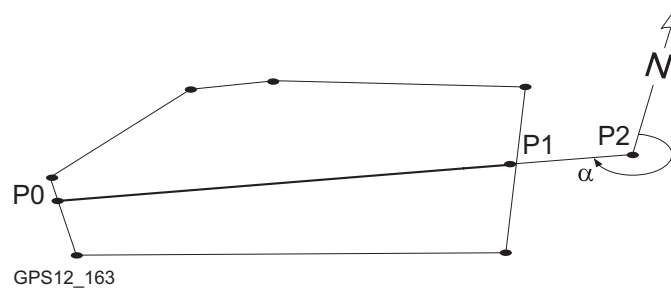

GPS12_163

- P0 First new COGO point
- P1 Second new COGO point
- P2 **<Rotation Pnt:>**
- α **<Azimuth:>**

37.11.2

Choosing an Area to be Divided

Access

Refer to "37.2 Accessing COGO" to access **COGO Choose Area to be Divided**.

COGO

Choose Area to be Divided

12:51
COGO
Choose Area to be Divided
Area to Use : **Select Existing**
Area ID : Area0001
No. of Points: 4
Area : 2604.46 m²
Perimeter : 222.331 m

CONT (F1)

To accept the changes and access the subsequent screen.

Q1 a ↑
CONT

Description of fields

Field	Option	Description
<Area to Use:>	Select Existing	The setting determines the availability of the subsequent fields and screen. To use an area from the <Job:> selected in COGO COGO Begin . The area can be edited and a new area can be created from points existing in the <Job:>.

Field	Option	Description
	Survey New Area	To survey points that do not exist in the job yet. The points will be added to a new area.
<Area ID:>	Choicelist User input	For <Area to Use: Select Existing >. To select the area to be divided. For <Area to Use: Survey New Area >. To enter a name for the new area.
<No. of Points:>	Output	Number of points forming the area.
<Area:>	Output	The size of the selected area.
<Perimeter:>	Output	The perimeter of the area.

Next step

IF	THEN
<Area to Use: Select Existing >	CONT (F1) accesses COGO Define How to Divide Area . Refer to "37.11.3 Dividing an Area".
<Area to Use: Survey New Area >	CONT (F1) accesses COGO Survey: Job Name . Refer to "COGO Survey: Job Name, Survey page".

COGO

Survey: Job Name, Survey page

Points to be added to the new area can be surveyed.

12:07	✓	✗	L1= 8	✗	0	1	A	B	
COGO	8	L2= 8	1	1	1	1	A	B	
Survey: swiss									
Survey	Code	3DCQ	Auto	Map					
Point ID	:	0001							
Antenna Ht	:	2.000 m							
3D CQ	:	0.011 m						Q1 a ↑	
OCUPY			DONE	H PNT	PAGE				

OCUPY (F1)

To start measuring the point to be added to the area. The position mode icon changes to the static icon. (F1) changes to **STOP**.

STOP (F1)

To end measuring the point. When <Auto STOP: Yes> in **CONFIGURE Point Occupation Settings**, recording of positions ends automatically as defined by the stop criteria. The position mode icon changes to the moving icon. (F1) changes to **STORE**.

STORE (F1)

To store the measured point. When <Auto STORE: Yes> in **CONFIGURE Point Occupation Settings**, the measured point is stored automatically. (F1) changes to **OCUPY**.

DONE (F4)

To end surveying an area and to access **COGO Edit Area: Area ID** where the area can be stored.

H PNT (F5)

To measure a hidden point. Refer to "46 Survey - Hidden Points".

PAGE (F6)

To change to another page on this screen.

SHIFT INIT (F2)

To select an initialisation method and to force a new initialisation. Available for configuration sets allowing phase fixed solutions. Refer to "44.6 Initialisation for Real-Time Rover Operations".

SHIFT INDIV (F5) and SHIFT RUN (F5)

To change between entering an individual point ID different to the defined ID template and the running point ID according to the ID template. Refer to "19.1 ID Templates".

Description of fields

Field	Option	Description
<Point ID:>	User input	<p>The identifier for manually occupied points. The configured point ID template is used. The ID can be changed in the following ways:</p> <ul style="list-style-type: none"> • To start a new sequence of point ID's type over the point ID. • For an individual point ID independent of the ID template SHIFT INDIV (F5). SHIFT RUN (F5) changes back to the next ID from the configured ID template. Refer to "19.1 ID Templates".

Field	Option	Description
<Antenna Ht:>	User input	The default antenna height as defined in the active configuration set is suggested. Refer to "2 Antenna Heights". Changing the antenna height here does not update the default antenna height as defined in the active configuration set. The changed antenna height is used until the application program is exited.
<3D CQ:>	Output	The current 3D coordinate quality of the computed position.

Next step

IF the task is to	THEN
change to another page on this screen	PAGE (F6).
stop surveying the area and to store the area	DONE (F4) and then STORE (F1) . COGO Define How to Divide Area is accessed. Refer to "37.11.3 Dividing an Area".
return to COGO Choose Area to be Divided	ESC.

37.11.3

Dividing an Area

Access

Refer to "37.11.2 Choosing an Area to be Divided" to access **COGO Define How to Divide Area**.

COGO
Define How to Divide
Area,
Input page

After each change of parameters in this screen, the values in the output fields are recalculated and updated.

14:02
 COGO
 Define How to Divide Area
 Input Map
 Divide By : Defined Line
 Using : Parallel Line
 Sub-Area-Grnd: 50.00 %
 Point A : pt 69
 Point B : pt 54
 Shift : By Distance
 HDist-Grnd : 20.000 m
 CALC INV SIZE LAST SURVY PAGE Q1a ↑

CALC (F1)

To perform the area division and to continue with the subsequent screen. Calculated COGO points are not yet stored.

INV (F2)

To calculate the value for the distance from two existing points. Available if <HDist-XX:> is highlighted.

SIZE (F3) and PERC (F3)

To display the size and the percentage of the sub-area.

LAST (F4)

To select the value for the distance from previous COGO inverse calculations. Available if <HDist-XX:> is highlighted.

SURVY (F5)

To manually occupy a point for the COGO calculation. Available if <Point A:>, <Point B:>, <Rotation Pnt:> or <Through Point:> is highlighted.

PAGE (F6)

To change to another page on this screen.

SHIFT CONF (F2)

To configure the COGO application program.

Description of fields

Field	Option	Description
<Divide By:>	Percentage	This field defines how the size of the sub area is defined. The size of the sub area is given in %.
	Area	The size of the sub area is given in m ² .
	Defined Line	The new border defining the size of the sub area is known.
<Using:>	Parallel Line	This field defines how the new border will run. The border will be parallel to a line defined by <Point A:> and <Point B:>.
	Perpendic Line	The border will be perpendicular to a line defined by <Point A:> and <Point B:>.
	Swing Line	The border will be a line rotated around <Rotation Pnt:> by <Azimuth:>.
<Sub-Area-XX:>	User input	For <Divide By: Percentage> and <Divide By: Area>. The size of the sub area must be typed either in % or in m ² .

Field	Option	Description
	Output	<p>When dividing the area using a parallel or perpendicular line, a reference line is defined by <Point A:> and <Point B:>. The direction of the new dividing line is always the same as the direction of the reference line. The sub area is always to the left of the new dividing line.</p> <p>When dividing an area using a swing line, the direction of the new dividing line is defined by the <Rotation Pnt:> and the <Azimuth:>. The sub area is always to the left of the new dividing line.</p> <p>For <Divide By: Defined Line>. The size of the sub area is calculated and displayed.</p>
<Point A:>	Choicelist	The first point of the line which is used as the reference for a new parallel or perpendicular border. All points from COGO Data: Job Name can be selected.
<Point B:>	Choicelist	The second point of the line which is used as the reference for a new parallel or perpendicular border. All points from COGO Data: Job Name can be selected.
<Shift:>	By Distance Through Point	<p>Available for <Divide By: Defined Line>.</p> <p>The new border will run in a certain distance from the line defined by <Point A:> and <Point B:>.</p> <p>The new border will run through a point defined in <Through Point:>.</p>
<Through Point:>	Choicelist	Available for <Shift: Through Point> . The point through which the new border will run.

Field	Option	Description
<Rotation Pnt:>	Choicelist	Available for <Using: Swing Line>. The point around which the new border will rotate by <Azimuth:>.
<Azimuth:>	Output	Available for <Using: Swing Line>. The angle of the new border from <Rotation Pnt:> to the new COGO point.
<HDist-XX:>	User input Output	The distance from the line defined by <Point A:> and <Point B:> to the new border. For <Divide By: Defined Line> and <Shift: By Distance>. For <Divide By: Percentage> or <Divide By: Area> with <Using: Parallel Line> or <Using: Perpendic Line>.

Next step

PAGE (F6) changes to the **Map** page. Refer to paragraph "COGO Define How to Divide Area, Map page".

COGO Define How to Divide Area, Map page

The **Map** page provides an interactive display of the data. Refer to "32 MapView Interactive Display Feature" for information on the functionality and softkeys available.

Next step

CALC (F1) performs the area division and accesses **COGO Results of Area Division**. Refer to "37.11.4 Results of the Area Division".

37.11.4

Results of the Area Division

Access

CALC (F1) in COGO Define How to Divide Area.

COGO

Results of Area Division,
Result page



Area Ratio : 2%:98%

Area 1-Grnd: 10.00 m²
Area 2-Grnd: 416.69 m²

CONT (F1)

To accept the calculation and to continue with the subsequent screen. Calculated COGO points are not yet stored.

PAGE (F6)

To change to another page on this screen.

SHIFT CONF (F2)

To configure the COGO application program.



Description of fields

Field	Option	Description
<Area Ratio:>	Output	The ratio of the size of the two sub areas in percent.
<Area 1-XX:>	Output	The size of the first sub area in m ² .
<Area 2-XX:>	Output	The size of the second sub area in m ² .

Next step

PAGE (F6) changes to the Plot page.

COGO
Results of Area Division,
Map page

The points defining the area and the calculated COGO points are shown in black.

Next step
CONT (F1) accesses **COGO Area Division Results**.

COGO
Area Division Results,
ResultX page

The coordinates of the intersection points of the new border with the original area are displayed.

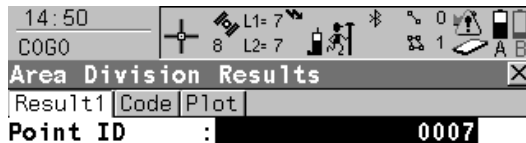

Easting : 764245.724 m
Northing : 252925.967 m
Ortho Ht : ----- m



STORE (F1)
To store the two results and to return to **COGO Choose Area to be Divided** once both points are stored.

COORD (F2)
To view other coordinate types.

RSLT1 (F3) or RSLT2 (F3)
To view the first and second result.

STAKE (F5)
To access the Stakeout application program and stake out the calculated COGO point.

PAGE (F6)
To change to another page on this screen.

SHIFT ELL H (F2) and SHIFT ORTH (F2)
To change between the ellipsoidal and the orthometric height.

SHIFT INDIV (F5) and SHIFT RUN (F5)
To change between entering an individual point ID different to the defined ID template and the running point ID according to the ID template. Refer to "19.1 ID Templates".

Description of fields

Field	Option	Description
<Point ID:>	User input	The identifier for the COGO point depending on the point ID template configured for <Survey Pts:> in CONFIGURE ID Templates .
<Ortho Ht:> or <Local Ell Ht:>	User input	A height value to be stored with the calculated point can be typed in.

Next step

PAGE (F6) changes to the **Code** page.

COGO
Area Division Results,
Code page

All codes of the job can be selected. Type in a code if required.

Next step

PAGE (F6) changes to the **Plot** page.

COGO
Area Division Results,
Plot page

The points defining the area and the points of the new border are shown in black.

Next step

STORE (F1) stores the results and accesses **COGO Choose Area to be Divided**. For <Write Logfile: Yes> in **COGO Configuration, Logfile** page the result is written to the logfile.

37.11.5

Working Example

Description

Application: Divide an area by a defined, parallel line. The new border has to run through a known point with the point ID 100.

Working technique: Real-time kinematic.

Goal: The points forming the original area are to be picked.
The area division is to be calculated.

Diagram

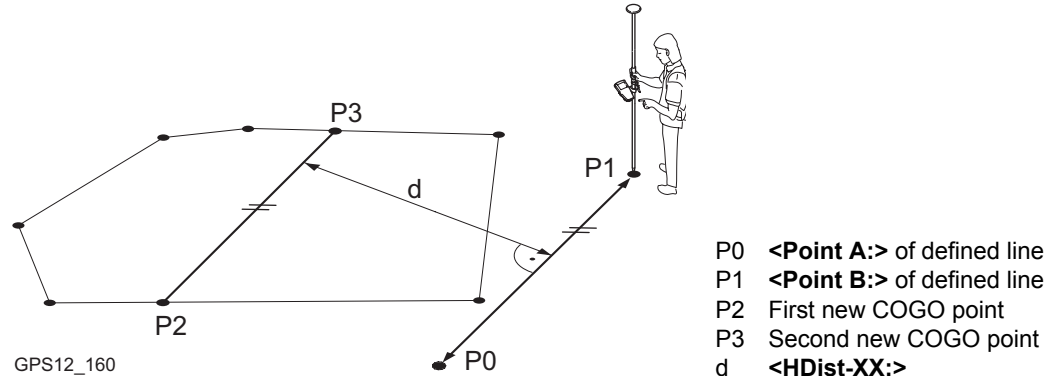





Requirements

- A real-time reference is running.
- For the rover: <R-Time Mode: Rover> in **CONFIGURE Real-Time Mode**.

Field procedure step-
by-step

Step	Description
1.	Main Menu: Programs...\COGO
2.	COGO COGO Begin Select a job and a configuration set with the settings mentioned above.
	CONF (F2) to configure the COGO application program.
3.	CONT (F1) to access COGO COGO Menu .
4.	Highlight Area Division .
5.	CONT (F1) to access COGO Choose Area to be Divided .
6.	COGO Choose Area to be Divided <Area to Use: Survey New Area> <Area ID:> Type in an ID for the new area.
7.	CONT (F1) to access COGO Survey: Job Name .
8.	COGO Survey: Job Name <Point ID:> Type in a name for the first point of the area.
9.	OCUPY (F1), STOP (F1) and STORE (F1) to survey the first point of the area.
10.	Survey all points belonging to the area. Point 100 must be part of the points.
11.	DONE (F4) once all points are surveyed.
12.	COGO Edit Area: Area ID Check the points forming the area.
13.	STORE (F1) to store the area and to access COGO Define How to Divide Area .
14.	COGO Define How to Divide Area, Input page

Step	Description
	<p><Divide By: Defined Line></p> <p><Using: Parallel Line></p> <p><Point A:> and <Point B:> Select the first and the second point of the line which is used as the reference for the new border. The new border will run parallel to this line.</p> <p><Shift: Through Point></p> <p><Through Point: 100></p>
15.	CALC (F1) to access COGO Results of Area Division .
16.	<p>COGO Results of Area Division, Result page</p> <p>The size of the two new sub areas is displayed,</p>
17.	CONT (F1) to access COGO Area Division Results .
18.	<p>COGO Area Division Results, Result1 page</p> <p><Point ID:> The identifier for the first COGO point depending on the point ID template configured for <Survey Pts:> in CONFIGURE ID Templates. The point ID can be changed.</p> <p><Ortho Ht:> or <Local Ell Ht:> are input fields. The height of the first point used in the COGO calculation is suggested. A height value to be stored with the calculated point can be typed in.</p> <p>The calculated coordinates are displayed.</p> <p>Type in a point ID.</p>
	COORD (F2) views other coordinate types.
	RSLT1 (F3) and RSLT2 (F3) to view the first and second result.

Step	Description
	STAKE (F5) to access the Stakeout application program and stake out the calculated COGO point.
	SHIFT ELL H (F2) and SHIFT ORTH (F2) . Available for local coordinates. Changes between the ellipsoidal and the orthometric height.
	SHIFT INDIV (F5) for an individual point ID independent of the ID template. SHIFT RUN (F5) changes back to the next ID from the configured ID template.
19.	STORE (F1) stores the first COGO point and displays the coordinates of the second COGO point.
20.	STORE (F1) stores the second COGO point and returns to COGO Choose Area to be Divided .
21.	SHIFT QUIT (F6) to exit the COGO application program.

37.12





Selecting a Result from Previous COGO Inverse Calculations

Description

Azimuths, distances and offsets required within the COGO traverse and intersection calculations can be selected from previously calculated inverse results.

Select a result from previous COGO inverse calculations step-by-step

Step	Description
1.	Refer to "37.2 Accessing COGO" to access COGO Traverse Input or COGO Intersection Input .
2.	COGO XX Input, Input page Highlight <Azimuth:>, <HDist-XX:> or <Offset:>.
3.	LAST (F4) to access COGO Last Inverse Calculations .
4.	COGO Last Inverse Calculations All previous COGO inverse calculations stored in the active job are displayed, sorted by time with the most recent at the top. This screen consists of three columns. <ul style="list-style-type: none">• First column From: The point ID of the first known point for the COGO inverse calculation.• Second column To: The point ID of the second known point for the COGO inverse calculation.• Third column: The information displayed can vary. ---- is displayed for unavailable information, for example if a height only point is used, Azimuth cannot be calculated. Azimuth: The direction from the first to the second known point.

Step	Description
	HDist-XX : The horizontal distance between the two known points. Date and Time when the COGO inverse calculation was stored.
	VIEW (F3) to view all calculated values for the highlighted COGO inverse calculation. This includes the height difference, the slope distance, the grade and the coordinate differences between the two known points.
	DEL (F4) to delete the highlighted COGO inverse calculation.
	MORE (F5) to display other information in the third column.
5.	Highlight the COGO inverse calculation of which a result is to be taken over into COGO XX Input, Input page.
6.	CONT (F1) to return to COGO XX Input, Input page.
	The relevant result of the highlighted COGO inverse calculation is copied into the field which was initially highlighted in COGO XX Input, Input page.

37.13

Modifying Values for Azimuths, Distances and Offsets

Description

The values for the azimuth, the distance and the offset required within the COGO traverse and intersection calculation can be mathematically modified.

Access step-by-step

Step	Description
1.	Refer to "37.2 Accessing COGO" to access COGO Traverse Input or COGO Intersection Input .
2.	COGO XX Input, Input page Highlight <Azimuth:>, <HDist-XX:> or <Offset:>.
3.	SHIFT MODIF (F4) to access COGO Modify Value .

COGO Modify Value

On this screen numbers can be typed in for the multiplication, division, addition and subtraction with the original azimuth, distance or offset value. The standard rules of mathematical operations apply.

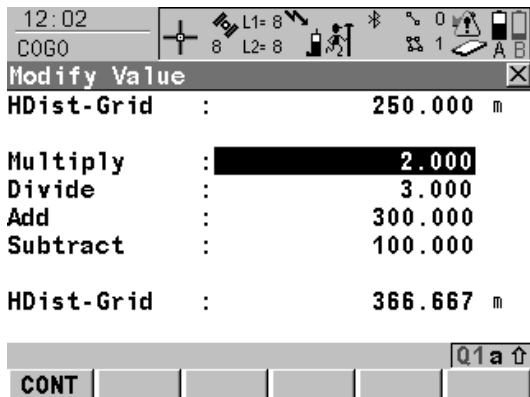

CONT (F1)

To accept the modified value and to return to the screen from where this screen was accessed. The modified value is copied into the field which was initially highlighted in **COGO XX Input, Input** page.

Description of fields

Field	Option	Description
<Azimuth:>, <HDist-XX:> or <Offset:>	Output	The name of the field and the value which was highlighted before accessing COGO Modify Value .
<Multiply:>	User input	The number to multiply by. <ul style="list-style-type: none"> • Minimum: -3000 • Maximum: 3000 • ----- performs a multiplication by 1.
<Divide:>	User input	The number to divide by. <ul style="list-style-type: none"> • Minimum: -3000

Field	Option	Description
		<ul style="list-style-type: none"> • Maximum: 3000 • ----- performs a division by 1.
<Add:>	User input	<p>The number to be added.</p> <ul style="list-style-type: none"> • For azimuths Minimum: 0 Maximum: Full circle • For distances and offsets Minimum: 0 m Maximum: 30000000 m • ----- performs an addition of 0.000.
<Subtract:>	User input	<p>The number to be subtracted.</p> <ul style="list-style-type: none"> • For azimuths Minimum: 0 Maximum: Full circle • For distances and offsets Minimum: 0 m Maximum: 30000000 m • ----- performs a subtraction of 0.000.
<Azimuth:>, <HDist-XX:> or <Offset:>	Output	<p>The modified value for the field in the first line. This field is updated with every mathematical operation. Angles greater than the full circle are reduced accordingly.</p>

Next step

CONT (F1) accepts the modified value and returns to the screen from where this screen was accessed.

Example: Calculations for an azimuth

Step	User input	Value as calculated	Value as displayed
			<Azimuth: 250.0000> g
1.	<Multiply: 2>	500	<Azimuth: 100.0000> g
2.	<Divide: 3>	166.667	<Azimuth: 166.6670> g
3.	<Add: 300>	466.667	<Azimuth: 66.6670> g
4.	<Subtract: 100>	366.667	<Azimuth: 366.6670> g

Example: Calculations for a distance

The behaviour for an offset is identical.

Step	User input	Value as calculated	Value as displayed
			<HDist-Grid: 250.000> m
1.	<Multiply: 2>	500	<HDist-Grid: 500.000> m
2.	<Divide: 3>	166.667	<HDist-Grid: 166.667> m
3.	<Add: 300>	466.667	<HDist-Grid: 466.667> m
4.	<Subtract: 100>	366.667	<HDist-Grid: 366.667> m

38**Determine Coordinate System - General****38.1****Overview****Description**

GPS measured points are always stored based on the global geocentric datum known as WGS 1984. Most surveys require coordinates in a local grid system, for example, based on a country's official mapping datum or an arbitrary grid system used in a particular area such as a construction site. To convert the WGS 1984 coordinates into local coordinates a coordinate system needs to be created. Part of the coordinate system is the transformation used to convert coordinates from the WGS 1984 datum to the local datum.

The Determine Coordinate System application program allows:

- the parameters of a new transformation to be determined.
- the parameters of an existing transformation to be recomputed.

Transformations

A transformation is the process of converting coordinates from one geodetic datum to another.

Requirements

- Transformation parameters.
- In some cases a local ellipsoid.
- In some cases a map projection.
- In some cases a geoid model.

Transformation parameters

A transformation consists of a number of shifts, rotations and scale factors, depending on the type of transformation used. Not all of these parameters are always required. These parameters may already be known, or may need to be computed.

Description of transformations

Three different transformations are provided:

- Classic 3D, also called Helmert transformation
- Onestep
- Twostep

Transformation	Characteristic	Description
Classic 3D	Principle	Transforms coordinates from WGS 1984 cartesian to local cartesian coordinates and vice versa. A map projection can then be applied to obtain grid coordinates. As a similarity transformation, it is the most rigorous transformation type and keeps the full geometrical information.
	Positions and heights	Positions and heights are linked. The accuracy is fully maintained and does not distort the measurements.
	Use	When measurements are to be kept totally homogeneous.

Transformation	Characteristic	Description
	Requirements	<ul style="list-style-type: none"> • The positions and heights are known in WGS 1984 and in the local system for at least three points. Four points or more are recommended in order to obtain higher redundancy. • Parameters of the local ellipsoid. • Parameters of the local map projection in order to convert between grid coordinates and geodetic coordinates. • Parameters of the local geoid model in order to convert between orthometric and ellipsoidal heights. This is not compulsory.
	Area	Especially wide networks with large height differences. Local grid coordinates must be accurate.
	Advantage	<ul style="list-style-type: none"> • Accuracy of the measurements is maintained. • It may be used over any area as long as the local coordinates, including heights, are accurate.
	Disadvantage	<ul style="list-style-type: none"> • The local ellipsoid and map projection must be known for the local grid coordinates. • In order to obtain accurate ellipsoidal heights the geoid separation at the measured points must be known. This may be determined from a geoid model. Refer to "13.2 Terminology".

Transformation	Characteristic	Description
	<p data-bbox="647 407 820 435">Requirements</p> <p data-bbox="647 781 708 809">Area</p>	<p data-bbox="879 172 1505 390">A site where the coordinates of the control points are based on a purely local grid. The coordinate values within this grid are totally arbitrary and are in no way connected with any ellipsoid or map projection. Obviously a Classic 3D transformation cannot be used here, as cartesian coordinates cannot be calculated from such a grid.</p> <ul data-bbox="879 407 1505 948" style="list-style-type: none"> <li data-bbox="879 407 1505 530">• The position is known in WGS 1984 and in the local system for at least one point. Three or more points are recommended in order to obtain redundancy. <li data-bbox="879 547 1505 603">• Additional height information for one point enables the transformation of heights. <li data-bbox="879 620 1505 676">• Parameters of the local geoid model. This is not compulsory. <li data-bbox="879 693 1505 721">• No parameters of the local ellipsoid. <li data-bbox="879 738 1505 766">• No parameters of the local map projection. <li data-bbox="879 782 1505 906">• Limited to about 10 x 10 km because no projection scale factor is applied and a standard Transverse Mercator projection is used to compute the preliminary WGS 1984 grid coordinates. <li data-bbox="879 922 1505 950">• For areas without large height differences.

Transformation	Characteristic	Description
	Points and transformation parameters	<p>The transformation parameters determined depend on the number of available points with position information.</p> <ul style="list-style-type: none"> • One point: Classic 2D with shift in X and Y. • Two points: Classic 2D with shift in X and Y, rotation about Z and scale. • More than two points: Classic 2D with shift in X and Y, rotation about Z, scale and residuals.
	Points and height transformation	<p>The type of height transformation performed depends on the number of available points with height information.</p> <ul style="list-style-type: none"> • No point: No height transformation. • One point: Heights are shifted to fit to the height control point. • Two points: Average height shift between the two height control points. • Three points: Tilted plane through the three height control points to approximate the local heights. • More than three points: Best fitting average plane.

Transformation	Characteristic	Description
	Advantage	<ul style="list-style-type: none">• Errors in height do not propagate into errors in position since the height and position transformations are separated.• If local heights have low accuracy or do not exist, a transformation of position can still be calculated and vice versa.• The height points and position points do not have to be the same points.• No parameters of the local ellipsoid and map projection is required.• Parameters may be computed with a minimum of points. Care should be taken when computing parameters using just one or two local points as the parameters calculated are valid in the vicinity of the points used for the transformation.
	Disadvantage	<ul style="list-style-type: none">• Restriction in the area over which the transformation can be applied. This is mainly due to the fact that there is no provision for scale factor in the projection.• The accuracy in height depends on the undulation of the geoid. The bigger the geoid variations the less accurate the results are.

Transformation	Characteristic	Description
Twostep	Principle	<p>Combines the advantages of the Onestep and the Classic 3D transformation. It allows treating position and height separately, but is not restricted to smaller areas. Procedure:</p> <ol style="list-style-type: none"> 1. The WGS 1984 coordinates of the common control points are shifted closely to the local datum using a given Classic 3D pre-transformation. This is typically a rough transformation valid for the country of the local datum. 2. The coordinates are projected onto a preliminary grid, but this time using the true map projection of the local points. 3. A 2D transformation is applied, exactly as with the Onestep transformation.
	Positions and heights	The position and height transformations are separated.
	Use	When measurements are to be forced to tie in with local existing control in areas larger than 10 x 10 km.
	Requirements	<ul style="list-style-type: none"> • The position is known in WGS 1984 and in the local system for at least one point. Four points or more are recommended in order to obtain higher redundancy. • Parameters of the local ellipsoid. • Parameters of the local map projection.

Transformation	Characteristic	Description
	Area	<ul style="list-style-type: none"> Parameters of a pre-transformation. Virtually any area as long as the local coordinates are accurate.
	Points and transformation parameters	Identical with the Onestep transformation.
	Points and height transformation	Identical with the Onestep transformation.
	Advantage	<ul style="list-style-type: none"> Errors in height do not propagate into errors in position since the height and position transformations are separated. If local heights have low accuracy or do not exist, a transformation of position can still be calculated and vice versa. The height points and position points do not have to be the same points. Fits much better over larger areas than a Onestep transformation. Reason:

Transformation	Characteristic	Description
	Disadvantage	<p>The first step of a Twostep transformation avoids any distortions due to the fact that the preliminary grid coordinates are built on a different ellipsoid than the local points. The second step ensures that the influence of the scale factor of the map projection is equally taken into account before the final 2D transformation is computed.</p> <ul style="list-style-type: none"> • The local ellipsoid must be known. • The map projection must be known. • A pre-transformation must be known. A null transformation can be used. • In order to obtain accurate ellipsoidal heights, the geoid separation at the measured points must be known. This may be determined from a geoid model.



With one common control point, it is still possible to calculate a Classic 3D transformation, as long as the rotations and the scale parameter are fixed. Such a transformation fits perfectly in the vicinity of the common control point, but is degraded by the distance from that point, because neither the orientation of the local reference frame nor any scale factor within the local datum can be taken into account.

Requirements to determine a transformation

To determine a transformation it is necessary to have common control points whose positions are known in both WGS 1984 coordinates and local coordinates. The more points that are common between datums the more accurately the transformation parameters can be

calculated. Depending on the type of transformation used, details about the map projection, the local ellipsoid and a local geoidal model may also be needed.

Requirements for control points

- The control points used for the transformation should surround the area for which the transformation is to be applied. It is not good practice to survey or convert coordinates outside of the area covered by the control points as extrapolation errors may be introduced.
- When a geoid field file and/or a CSCS field file is used in the determination of a coordinate system, the control points for the calculation must fall within the areas of the field files.

Coordinate system determination methods

Two different methods for determining a coordinate system are available:

Coordinate system determination method	Characteristic	Description
Normal	Number of control points needed	One or more control points for both the WGS 1984 and the local datum.
	Transformation to use	Onestep, Twostep or Classic 3D, depending on number of control points and available information.
One point localisation	Number of control points needed	One control point for both the WGS 1984 and the local datum.

Coordinate system determination method	Characteristic	Description
	Transformation to use	<ul style="list-style-type: none"><li data-bbox="1155 165 1492 288">• Onestep or Twostep when information about the necessary rotations and scale factor is known.<li data-bbox="1155 303 1492 423">• Classic 3D when the rotations are to be set to zero and the scale factor to one.

38.2

Accessing Determine Coordinate System

Access

Select **Main Menu: Programs... \ Determine Coordinate System.**

OR

Press **PROG**. Highlight **Determine Coordinate System. CONT (F1)**. Refer to "36.2 Accessing the Application Programs Menu" for information on the **PROG** key.

OR

Press a hot key configured to access the screen **DET C SYS Determine Coord System Begin**. Refer to "6.1 Hot Keys" for information on hot keys.

OR

Press **USER**. Refer to "6.2 USER Key" for information on the **USER** key.

DET C SYS
Determine Coord
System Begin

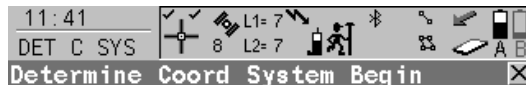

Name : **New Coord System**

WGS84 Pts Job: **WGS84 Job** **↔**

Local Pts Job: **Local Job** **↔**

Method : **Normal** **↔**

**CONT (F1)**

To confirm the selections and to continue with the subsequent screen.

CONF (F2)

To configure the coordinate system determination method selected in **<Method:>**.

CSYS (F6)

Available for **<Method: Normal>**. To access **DET C SYS Coordinate Systems** and choose a coordinate system to edit. Refer to "13.4.2 Editing a Coordinate System".

Description of fields

Field	Option	Description
<Name:>	User input	<p>A unique name for the coordinate system. The name may be up to 16 characters in length and may include spaces. Input is mandatory.</p> <p> Entering the name of a coordinate system will allow that existing system to be updated. Refer to "13.4.2 Editing a Coordinate System".</p>
<WGS84 Pts Job:>	Choicelist	<p>The job from which the points with WGS84 coordinates will be taken. Opening the choicelist accesses MANAGE Jobs (Device). Refer to "8 Manage...\Jobs".</p>
<Local Pts Job:>	Choicelist	<p>The job from which the points with local coordinates will be taken. Opening the choicelist accesses MANAGE Jobs (Device). Refer to "8 Manage...\Jobs".</p>
<Method:>	Normal or One Pt Localistn	Method used to determine the coordinate system.

Next step

IF	AND	THEN
<Method: Normal>	the DET C SYS application program needs configuring	CONF (F2) to access DET C SYS Configuration . Refer to "38.3.1 Configuring Determine Coordinate System - Normal".
<Method: One Pt Localistn>	the DET C SYS application program needs configuring	CONF (F2) to access DET C SYS Configuration . Refer to "38.3.2 Configuring Determine Coordinate System - One Point Localisation".
<Method: Normal>	the DET C SYS application program does not need configuring	CONT (F1) to access DET C SYS Step 1: Choose Transform Type . Refer to "39 Determine Coordinate System - Normal".
<Method: One Pt Localistn>	the DET C SYS application program does not need configuring	CONT (F1) to access DET C SYS Step 1: Choose Transform Type . Refer to "40 Determine Coordinate System - One Point Localisation".

38.3

Configuring Determine Coordinate System

38.3.1

Configuring Determine Coordinate System - Normal

Description

The configuration of **DET C SYS**, normal method, allows options to be set which are used as the default options within the Determine Coordinate System application program when using the normal method. These settings are stored within the active configuration set.

Access step-by-step

Step	Description
1.	Refer to "38.2 Accessing Determine Coordinate System" to access DET C SYS Determine Coord System Begin .
2.	CONF (F2) to access DET C SYS Configuration, Method page.
3.	Select <Default Method: Normal> .

DET C SYS Configuration, Method page

This screen consists of the **Method** page, the **Residuals** page and the **Classic 3D** page. The explanations for the softkeys given below are valid for all pages, unless otherwise stated.

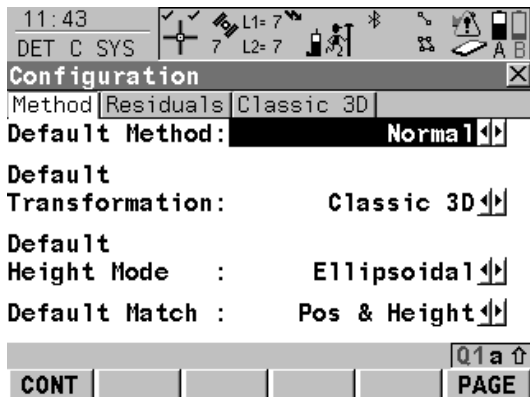

CONT (F1)

To accept changes and return to the screen from where this screen was accessed.

FIX (F4) or ADJUST (F4)

Available for **Classic 3D** page unless **<Transf Model:>** is highlighted. To define which parameters are computed or fixed in the Classic 3D transformation. Refer to paragraph "DET C SYS Configuration, Classic 3D page".

PAGE (F6)

To change to another page on this screen.

Description of fields

Field	Option	Description
<Default Method:>	Normal or One Pt Localistn	Method used to determine the coordinate system.  The fields and pages available are different if <Default Method: One Pt Localistn> is selected. Refer to "38.3.2 Configuring Determine Coordinate System - One Point Localisation" for information on how to configure DET C SYS using the one point localisation method.
<Default Transformation:>	Onestep, Twostep or Classic 3D	The default transformation to be used when determining the coordinate system. Refer to "38.1 Overview".

Field	Option	Description
<Default Height Mode:>	Orthometric or Ellipsoidal	The default height type to be used when determining the coordinate system.
<Default Match:>	Pos & Height, Pos Only, Height Only or <None>	Options available depend on the choice made for <Default Transformation:>. Point parameters to be matched between points in both datums.

Next step

PAGE (F6) changes to the **Residuals** page. Refer to paragraph "DET C SYS Configuration, Residuals page".

DET C SYS Configuration, Residuals page

Description of fields

Field	Option	Description
<Easting:>	User input	The limit above which Easting residuals will be flagged as possible outliers.
<Northing:>	User input	The limit above which Northing residuals will be flagged as possible outliers.
<Height:>	User input	The limit above which Height residuals will be flagged as possible outliers.
<Default Residual Distbtn:>	None	The method by which the residuals of the control points will be distributed throughout the transformation area. No distribution is made. Residuals remain with their associated points.

Field	Option	Description
	1/Distance^{XX}	Distributes the residuals according to the distance between each control point and the newly transformed point.
	Multiquadratic	Distributes the residuals using a multiquadratic interpolation approach.

Next step

PAGE (F6) changes to the **Classic 3D** page. Refer to paragraph "DET C SYS Configuration, Classic 3D page".

**DET C SYS
Configuration,
Classic 3D page**

The settings on this page define the parameters to be used in a Classic 3D transformation. Refer to "13.2 Terminology" for more information about how many transformation parameters are computed, based on the number of points common to both datums.

IF the value for a field is	THEN the value for this parameter will be
-----	calculated.
any number	fixed to that value.

Description of fields

Field	Option	Description
<Transf Model:>	Bursa Wolf or Molodensky-Bad	The transformation model to be used. Refer to standard surveying literature for details on the models.
<Shift dX:>	User input	Shift in X direction.
<Shift dY:>	User input	Shift in Y direction.
<Shift dZ:>	User input	Shift in Z direction.
<Rotation X:>	User input	Rotation around the X axis.
<Rotation Y:>	User input	Rotation around the Y axis.
<Rotation Z:>	User input	Rotation around the Z axis.
<Scale:>	User input	Scale factor.

Next step

IF	AND	THEN
a field displays -----	the parameter needs to be fixed to a value	highlight the field. FIX (F4) . Enter the value of the parameter.
a field displays a value	the parameter needs to be calculated	highlight the field. ADJST (F4) .

IF	AND	THEN
all parameters are configured	-	CONT (F1) to return to DET C SYS Determine Coord System Begin.

38.3.2

Configuring Determine Coordinate System - One Point Localisation

Description

The configuration of **DET C SYS**, one point localisation method, allows options to be set which are used as the default options within the Determine Coordinate System application program when using the one point localisation method. These settings are stored within the active configuration set.

Access step-by-step

Step	Description
1.	Refer to "38.2 Accessing Determine Coordinate System" to access DET C SYS Determine Coord System Begin .
2.	CONF (F2) to access DET C SYS Configuration, Method page.
3.	Select <Default Method: One Pt Localistn> .

DET C SYS Configuration, Method page

This screen consists of the **Method** page, the **Onestep** page, the **Twostep** page and the **Classic 3D** page. The explanations for the softkeys given below are valid for all pages.

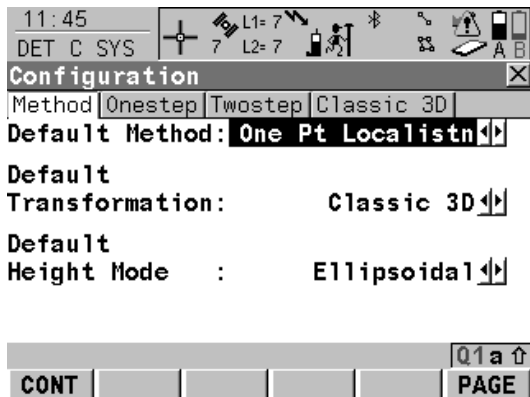

CONT (F1)

To accept changes and return to the screen from where this screen was accessed.

PAGE (F6)

To change to another page on this screen.

Description of fields

Field	Option	Description
<Default Method:>	Normal or One Pt Localistn	Method used to determine the coordinate system.  The fields and pages available are different if <Default Method: Normal> is selected. Refer to "38.3.1 Configuring Determine Coordinate System - Normal" for information on how to configure DET C SYS using the normal method.
<Default Transformation:>	Onestep, Twostep or Classic 3D	The default transformation to be used when determining the coordinate system. Refer to "13.2 Terminology".

Field	Option	Description
<Default Height Mode:>	Orthometric or Ellipsoidal	The default height mode to be used when determining the coordinate system.

Next step

PAGE (F6) changes to the **Onestep** page. Refer to paragraph "DET C SYS Configuration, Onestep page".

DET C SYS Configuration, Onestep page

Description of fields

Field	Option	Description
<Default Rotation:>	Use WGS84 North	The default rotation method to be used in the transformation process.
	User Entered	Rotate to North as defined by WGS 1984.
	Convergence Angle	Rotation can be manually typed in.
	Two WGS84 Points	Angle between grid North and geodetic North at a certain point. Refer to "40.2 Determine Coordinate System - Onestep Transformation" paragraph "DET C SYS Step 4: Determine Rotation" for a diagram.
<Default Height SF:>		Rotation defined by two points on the WGS 1984 datum. Refer to "40.2 Determine Coordinate System - Onestep Transformation" paragraph "DET C SYS Step 4: Determine Rotation" for a diagram.
<Default Height SF:>		The default method for determining the height scale factor to be used in the transformation process.

Field	Option	Description
	User Entered	Height scale factor can be manually typed in.
	Known WGS84 Pt	Height scale factor defined by a known point on the WGS 1984 datum.
	Known WGS84 Ht	Height scale factor defined by the known height of a point on the WGS 1984 datum.

Next step

PAGE (F6) changes to the **Twostep** page. Refer to paragraph "DET C SYS Configuration, Twostep page".

**DET C SYS
Configuration,
Twostep page**

Description of fields

Field	Option	Description
<Default Rotation:>	Use WGS84 North	The default rotation method to be used in the transformation process.
	User Entered	Rotate to North as defined by WGS 1984.
	Convergence Angle	Rotation can be manually typed in.
		Angle between grid North and geodetic North at a certain point. Refer to "40.2 Determine Coordinate System - Onestep Transformation" paragraph "DET C SYS Step 4: Determine Rotation" for a diagram.

Field	Option	Description
	Two WGS84 Points	Rotation defined by two points on the WGS 1984 datum. Refer to "40.2 Determine Coordinate System - Onestep Transformation" paragraph "DET C SYS Step 4: Determine Rotation" for a diagram.
<Default Scale:>	User Entered Compute CSF	The default method for determining the scale factor to be used in the transformation process. Scale factor can be manually typed in Compute the combined grid and height scale factor.
<Defltd Grid SF:>	User Entered or Known Local Pt	Available for <Default Scale: Compute CFS> . Default method for computing the grid scale factor of the known point.
<Defltd Ht SF:>	User Entered, Known Local Pt or Known Local Ht	Available for <Default Scale: Compute CFS> . Default method for computing the height scale factor of the known point.

Next step

PAGE (F6) changes to the **Classic 3D** page. Refer to paragraph "DET C SYS Configuration, Classic 3D page".

DET C SYS Configuration, Classic 3D page

Description of fields

Field	Option	Description
<Default Local Height:>	Use WGS84 Pt Ht or Use Local Pt Ht	Source of height information to use.

Next step

CONT (F1) returns to **DET C SYS Determine Coord System Begin.**

39**Determine Coordinate System - Normal****39.1****Overview****Description**

The Determine Coordinate System application program allows a new coordinate system to be determined or a coordinate system to be updated. The coordinate system is defined by the transformation used to convert coordinates from one geodetic datum to another. Onestep, Twostep or Classic 3D transformations are available. Refer to "38 Determine Coordinate System - General" for more information.

Next step

IF	THEN
a new coordinate system is to be determined	Refer to "39.2 Determining a New Coordinate System".
a coordinate system is to be updated	Refer to "39.3 Updating a Coordinate System".

39.2

Determining a New Coordinate System

Access step-by-step

Step	Description
1.	Refer to "38.2 Accessing Determine Coordinate System" to access DET C SYS Determine Coord System Begin .
2.	Select <Method: Normal> .
3.	CONT (F1) to access DET C SYS Step 1: Choose Transform Type .

DET C SYS Step 1: Choose Transform Type

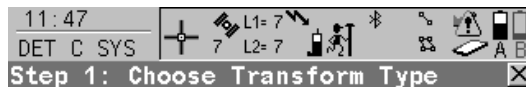

Transform Name: **New Coord System**
Transform Type: **Classic 3D**
Height Mode : **Ellipsoidal**



CONT (F1)

To confirm the selections and to continue with the subsequent screen.

Description of fields

Field	Option	Description
<Transfrm Name:>	User input	A unique name for the transformation. The name may be up to 16 characters in length and may include spaces. If a coordinate system is being updated then its name is displayed.
<Transfrm Type:>	Onestep, Twostep or Classic 3D Output	The type of transformation to be used when determining a coordinate system. Available when determining a new coordinate system. Available when updating a coordinate system. The transformation type shown is the same as the transformation used in the existing system.
<Height Mode:>	Orthometric or Ellipsoidal Output	The height mode to be used in the determination of a coordinate system. Available when determining a new coordinate system. Available when updating a coordinate system. The height mode shown is the same as the mode used in the existing system.

Next step

CONT (F1) continues to **DET C SYS Step 2: Choose Parameters.**



If a coordinate system was chosen to be edited in **DET C SYS Determine Coord System Begin**, pressing **CONT (F1)** accesses **DET C SYS Step 3: Match Points (n)**. Pressing **ESC** does not re-access **DET C SYS Determine Coord System Begin** but accesses **DET C SYS Step 2: Choose Parameters** and **DET C SYS Step 1: Choose Transform Type**.

**DET C SYS
Step 2: Choose Parameters**

This screen contains different fields, depending on what transformation type was chosen in **DET C SYS Step 1: Choose Transform Type**.

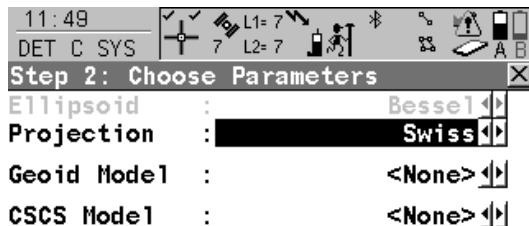

CONT (F1)

To confirm the selections and to continue with the subsequent screen.



For <Transform Type: Onestep>

Description of fields

Field	Option	Description
<Geoid Model:>	Choicelist	The geoid model to be used in the transformation. Geoid models from MANAGE Geoid Models can be selected.

For <Transfrm Type: Twostep>

Description of fields

Field	Option	Description
<Pre Transform:>	Choicelist	The pre-transformation to use for the preliminary 3D transformation. All 3D transformations from MANAGE Transformations can be selected.
<Ellipsoid:>	Choicelist Output	The ellipsoid to use in the transformation. All ellipsoids from MANAGE Ellipsoids can be selected. The ellipsoid being used by a fixed projection when selected in <Projection:>.
<Projection:>	Choicelist	The projection to use in the transformation. All projections from MANAGE Projections can be selected.
<Geoid Model:>	Choicelist	The geoid model to be used in the transformation. Geoid models from MANAGE Geoid Models can be selected.

For <Transfrm Type: Classic 3D>

Description of fields

Field	Option	Description
<Ellipsoid:>	Choicelist	The ellipsoid to use in the transformation. All ellipsoids from MANAGE Ellipsoids can be selected.

Field	Option	Description
	Output	The ellipsoid being used by a fixed projection when selected in <Projection:> .
<Projection:>	Choicelist	The projection to use in the transformation. All projections from MANAGE Projections can be selected.
<Geoid Model:>	Choicelist	The geoid model to use in the transformation. Geoid models from MANAGE Geoid Models can be selected.
<CSCS Model:>	Choicelist	The CSCS model to use in the transformation. All CSCS models from MANAGE CSCS Models can be selected.

Next step

CONT (F1) continues to **DET C SYS Step 3: Match Points (n)**.

DET C SYS Step 3: Match Points (n)

This screen provides a list of points chosen from **<WGS84 Pts Job:>** and **<Local Pts Job:>**. The number of control points matched between both jobs is indicated in the title, for example **DET C SYS Step 3: Match Points (4)**. Unless there is no pair of matching points in the list all softkeys are available. Refer to "39.4 Matching Points" for information on how to match points.

MGS84 Pts	Local Pts	Match
101	101	P & H
200	200	P & H
300	300	P & H
400	400	P & H

CALC NEW EDIT DEL MATCH AUTO

CALC (F1)

To confirm the selections, compute the transformation and continue with the subsequent screen.

NEW (F2)

To match a new pair of points. This pair is added to the list. A new point can be manually occupied. Refer to "39.4.2 Selecting a New Pair of Matching Points".

EDIT (F3)

To edit the highlighted pair of matched points. Refer to "39.4.3 Editing a Pair of Matching Points".

DEL (F4)

To delete the highlighted pair of matched points from the list.

MATCH (F5)

To change the type of match for a highlighted pair of matched points. Refer to "Description of columns".

AUTO (F6)

To scan both jobs for points that have the same point ID. Points with matching point ID's are added to the list.

SHIFT PARAM (F5)

Available for <Transform Type: Classic 3D> in **DET C SYS Step 1: Choose Transform Type**. To configure Classic 3D transformation parameters. Refer to "38.3.1 Configuring Determine Coordinate System - Normal" paragraph "DET C SYS Configuration, Classic 3D page".

Description of columns

Column	Description
WGS84 Pts	The point ID of the points chosen from <WGS84 Pts Job:>.
Local Pts	The point ID of the points chosen from <Local Pts Job:>.
Match	<p>The type of match to be made between the points. This information is used in the transformation calculation. Position & Height, Position only, Height only or None.</p> <ul style="list-style-type: none">• For <Transform Type: Onestep> or <Transform Type: Twostep> possible options are P & H, P only, H only or None.• For <Transform Type: Classic 3D> possible options are P & H or None. <p>None removes matched common points from the transformation calculation but does not delete them from the list. This can be used to help improve residuals.</p>

Next step

CALC (F1) computes the transformation and continues to **DET C SYS Step 4: Check Residuals**. Refer to paragraph "DET C SYS Step 4: Check Residuals".



If a coordinate system to be updated contains a point that was deleted from the active job and a new point was created in that job with the same point ID but different coordinates, the coordinates of the old point will still be used for the calculation. Pressing **EDIT (F3)** to edit a highlighted pair of matched points containing the deleted point, will overwrite the coordinates of the old point and the coordinates of the new point will be used in the calculation.

DET C SYS
Step 4: Check Residuals

Displays a list of the matched points used in the transformation calculation and their associated residuals.

WGS84 Pts	East[m]	North[m]
101	0.009?	0.004
200	0.000	0.003
300	-0.002	-0.004
400	-0.008	-0.004?

Q1 a ↑

CONT RESULT MORE

CONT (F1)

To accept the residuals and to continue with the subsequent screen.

RESULT (F3)

To view results of the transformation.

Accesses **DET C SYS Transformation Results**. Refer to "39.5 Transformation Results".

MORE (F5)

To display information about height residuals.

Description of columns

Column	Description
WGS84 Pts	The point ID of the points chosen from <WGS84 Pts Job:> .
East	The Easting residual. If positions were not used in the transformation calculation then ----- will be displayed.
North	The Northing residual. If positions were not used in the transformation calculation then ----- will be displayed.
Height	The Height residual. If heights were not used in the transformation calculation then ----- will be displayed.
!	Indicates residuals that exceed the residual limit defined in DET C SYS Configuration, Residuals page.
!	Indicates the largest residual in East, North and Height .

Next step

IF the residuals are	THEN
unacceptable	ESC returns to DET C SYS Step 3: Match Points (n) . Matched points can be edited, deleted or temporarily removed from the list and the transformation recalculated.
acceptable	CONT (F1) continues to DET C SYS Step 5: Store Coord System .

DET C SYS**Step 5: Store Coord System, Summary page**

This screen consists of the **Summary** page and the **Coord System** page. The **Coord System** page contains different fields, depending on what transformation type was chosen in **DET C SYS Step 1: Choose Transform Type**. The explanations for the softkeys given below are valid for all pages.

11:47
DET C SYS

Step 5: Store Coord System

Summary | Coord System

Name : **New Coord System**

Transform Type: **Classic 3D**

Matched Pts : **4**

Largest Residuals

Easting : **0.008 m**

Northing : **0.007 m**

Height : **0.002 m**

Q1a ↑

STORE **PAGE**

STORE (F1)

To store the coordinate system to the DB-X and return to **GPS1200 Main Menu**.

PAGE (F6)

To change to another page on this screen.

Description of fields

Field	Option	Description
<Name:>	User input	The name of the coordinate system can be changed. The name may be up to 16 characters in length and may include spaces.
<Transform Type:>	Output	The type of transformation used, as defined in DET C SYS Step 1: Choose Transform Type .

Field	Option	Description
<Matched Pts:>	Output	Number of matched points, as defined in DET C SYS Step 3: Match Points (n) .
<Easting:>	Output	Largest Easting residual from the transformation calculation.
<Northing:>	Output	Largest Northing residual from the transformation calculation.
<Height:>	Output	Largest Height residual from the transformation calculation.

Next step

PAGE (F6) changes to the **Coord System** page. Refer to paragraph "DET C SYS Step 5: Store Coord System, Coord System page".

DET C SYS Step 5: Store Coord System, Coord System page

For <Transfrm Type: Onestep>

Description of fields

Field	Option	Description
<Residuals:>	None, 1/Distance^{XX} or Multiquadratic	The method by which the residuals of the control points will be distributed throughout the transformation area. Refer to "38.3.1 Configuring Determine Coordinate System - Normal" paragraph "DET C SYS Configuration, Residuals page".
<Geoid Model:>	Output	Name of geoid model used, as defined in DET C SYS Step 2: Choose Parameters .

For <Transform Type: Twostep>

Description of fields

Field	Option	Description
<Residuals:>	None, 1/Distance ^{XX} or Multiquadratic	The method by which the residuals of the control points will be distributed throughout the transformation area. Refer to "38.3.1 Configuring Determine Coordinate System - Normal" paragraph "DET C SYS Configuration, Residuals page".
<Pre Transform:>	Output	Name of the pre-transformation used, as defined in DET C SYS Step 1: Choose Transform Type.
<Ellipsoid:>	Output	Name of ellipsoid used, as defined in DET C SYS Step 2: Choose Parameters.
<Projection:>	Output	Name of projection used, as defined in DET C SYS Step 2: Choose Parameters.
<Geoid Model:>	Output	Name of geoid model used, as defined in DET C SYS Step 2: Choose Parameters.

For <Transform Type: Classic 3D>

Description of fields

Field	Option	Description
<Residuals:>	None, 1/Distance ^{XX} or Multiquadratic	The method by which the residuals of the control points will be distributed throughout the transformation area. Refer to "38.3.1 Configuring Determine Coordinate System - Normal" paragraph "DET C SYS Configuration, Residuals page".
<Transform:>	Output	Name of transformation used, as defined in DET C SYS Step 1: Choose Transform Type .
<Ellipsoid:>	Output	Name of ellipsoid used, as defined in DET C SYS Step 2: Choose Parameters .
<Projection:>	Output	Name of projection used, as defined in DET C SYS Step 2: Choose Parameters .
<Geoid Model:>	Output	Name of geoid model used, as defined in DET C SYS Step 2: Choose Parameters .
<CSCS Model:>	Output	Name of CSCS model used, as defined in DET C SYS Step 2: Choose Parameters .

Next step

STORE (F1) stores the coordinate system to the DB-X and attaches it to the **<WGS84 Pts Job:>** selected in **DET C SYS Determine Coord System Begin**, replacing any coordinate system attached to this job. **<WGS84 Pts Job:>** becomes the active job.

39.3

Updating a Coordinate System

Access step-by-step

Step	Description
1.	Refer to "38.2 Accessing Determine Coordinate System" to access DET C SYS Determine Coord System Begin .
2.	Select <Method: Normal> .
3.	Enter the name of a coordinate system in <Name:> . OR CSYS (F6) to select a coordinate system.
4.	CONT (F1) to access DET C SYS Step 3: Match Points (n) .
5.	All the following steps are identical with the determination of a new coordinate system from DET C SYS Step 3: Match Points (n) onwards. Refer to "39.2 Determining a New Coordinate System". Follow the instructions from paragraph "DET C SYS Step 3: Match Points (n)" onwards.

39.4

Matching Points

39.4.1

Overview

Description

Before calculating a transformation, it must be defined which points in **<WGS84 Pts Job:>** and **<Local Pts Job:>** are to be matched. Pairs of matched points are displayed in one line in **DET C SYS Step 3: Match Points (n)**. New pairs of matched points can be created, existing pairs of matched points can be edited and pairs of matched points can be deleted.

39.4.2

Selecting a New Pair of Matching Points

Match points step-by-step

Step	Description
1.	Refer to "39.2 Determining a New Coordinate System" to access DET C SYS Step 3: Match Points (n) .
2.	NEW (F2) to access DET C SYS Choose Matching Points .
3.	<p>DET C SYS Choose Matching Points</p> <p><WGS84 Point:> A WGS 1984 control point. All WGS 1984 stored points from MANAGE Data: Job Name can be selected.</p> <p><Known Point:> A local control point. All local stored points from MANAGE Data: Job Name of any class, except NONE, can be selected.</p> <p><Match Type:> The type of match to be made between the points selected in <WGS84 Point:> and <Known Point:>. Position and Height, Position Only, Height Only or None.</p> <ul style="list-style-type: none"> For <Transfrm Type: Onestep> or <Transfrm Type: Twostep> possible options are Pos & Ht, Pos Only, Height Only or None. For <Transfrm Type: Classic 3D> possible options are Pos & Ht or None. <p>Select a control point from both jobs that occupy the same position on the different datums.</p>
	SURVY (F5) . Available when <WGS84 Point:> is highlighted. To manually occupy a point and store it in <WGS84 Pts Job:> .
4.	CONT (F1) returns to DET C SYS Step 3: Match Points (n) and adds a new line of matched points to the matched points list.

39.4.3

Editing a Pair of Matching Points

Edit matching points step-by-step

Step	Description
1.	Refer to "39.2 Determining a New Coordinate System" to access DET C SYS Step 3: Match Points (n) .
2.	DET C SYS Step 3: Match Points (n) Highlight the pair of matching points to be edited.
3.	EDIT (F3) to access DET C SYS Edit Matching Points .
4.	All the following steps are identical with the selecting of new matching points. Refer to "39.4.2 Selecting a New Pair of Matching Points". Follow the instructions from step 3. onwards.

39.5

Transformation Results

39.5.1

Accessing Transformation Results

Access step-by-step

Step	Description
	The results of a transformation can be displayed during the process of determining or updating a coordinate system.
1.	Refer to "39.2 Determining a New Coordinate System". Follow the instructions to access DET C SYS Step 4: Check Residuals .
2.	RESLT (F3) to access DET C SYS Transformation Results .

Next step

IF	THEN
<Transfrm Type: Onestep> or <Transfrm Type: Twostep>	Refer to "39.5.2 Results for Onestep and Twostep Transformations".
<Transfrm Type: Classic 3D>	Refer to "39.5.3 Results for Classic 3D Transformation".

39.5.2

DET C SYS Transformation Results, Position page

Results for Onestep and Twostep Transformations

Results of the transformation between the WGS 1984 datum and the local datum are shown for each of the transformation parameters. This screen consists of the **Position** page and the **Height** page. The explanations for the softkeys given below are valid for the pages as indicated.

The screenshot shows a handheld device screen with a status bar at the top displaying '11:48' and 'DET C SYS'. Below the status bar is a toolbar with various icons. The main display area is titled 'Transformation Results' and is divided into two sections: 'Position' and 'Height'. The 'Position' section displays the following parameters:

Shift dX	:	249519.0014	m
Shift dY	:	758220.2394	m
Rotation	:	-5511.36979	"
Scale	:	34.6421	ppm
Rot Orig X	:	3.6845	m
Rot Orig Y	:	5.8791	m

The 'Height' section is currently empty. At the bottom of the screen, there are several softkeys: 'CONT', 'SCALE', 'RMS', and 'PAGE'. A 'Q1 a ↑' softkey is also visible on the right side of the screen.

CONT (F1)

To return to **DET C SYS Step 4: Check Residuals**.

SCALE (F4) or PPM (F4)

Available on the **Position** page. To switch between **<Scale:>** displaying the true scale and displaying the ppm.

RMS (F5) or PARAM (F5)

To switch between the root mean square values of the parameters and the actual parameter values. The name of the screen changes to **DET C SYS Transformation Results rms** when displaying rms values.

PAGE (F6)

To change to another page on this screen.

Description of fields

Field	Option	Description
<Shift dX:>	Output	Shift in X direction.
<Shift dY:>	Output	Shift in Y direction.

Field	Option	Description
<Rotation:>	Output	Rotation of transformation.
<Scale:>	Output	Scale factor used in transformation. Either true scale or ppm.
<Rot Orig X:>	Output	Position in the X direction of the origin of rotation.
<Rot Orig Y:>	Output	Position in the Y direction of the origin of rotation.

Next step

PAGE (F6) changes to the **Height** page. Refer to paragraph "DET C SYS Transformation Results, Height page".

**DET C SYS
Transformation
Results,
Height page**

Description of fields

Field	Option	Description
<Slope in X:>	Output	Tilt of the transformation in the X direction.
<Slope in Y:>	Output	Tilt of the transformation in the Y direction.
<Height Shift:>	Output	Shift in height between WGS 1984 datum and local datum.

Next step

CONT (F1) returns to **DET C SYS Step 4: Check Residuals**.

39.5.3

DET C SYS Transformation Results, Parameters page

Results for Classic 3D Transformation

Results of the transformation between the WGS 1984 datum and the local datum are shown for each of the transformation parameters. This screen consists of the **Parameters** page and the **Rotn Origin** page. The explanations for the softkeys given below are valid for the pages as indicated.

The screenshot shows a handheld device screen with a status bar at the top displaying '11:46' and 'DET C SYS'. Below the status bar is a toolbar with various icons. The main display area is titled 'Transformation Results' and is divided into two sections: 'Parameters' and 'Rotn Origin'. The 'Parameters' section lists the following values:

Shift dX	:	-665.0537	m
Shift dY	:	-2.1071	m
Shift dZ	:	-365.9000	m
Rotation X	:	-0.96799	"
Rotation Y	:	-0.75489	"
Rotation Z	:	-0.57971	"
Scale	:	-5.7349	ppm

At the bottom of the screen, there is a row of softkeys: 'CONT', 'SCALE', 'RMS', and 'PAGE'. The 'PAGE' softkey has a small icon above it.

CONT (F1)

To return to **DET C SYS Step 4: Check Residuals**.

SCALE (F4) or PPM (F4)

Available on the **Parameters** page. To switch between **<Scale:>** displaying the true scale and displaying the ppm.

RMS (F5) or PARAM (F5)

To switch between the root mean square values of the parameters and the actual parameter values.

PAGE (F6)

To change to another page on this screen.

Description of fields

Field	Option	Description
<Shift dX:>	Output	Shift in X direction.
<Shift dY:>	Output	Shift in Y direction.
<Shift dZ:>	Output	Shift in Z direction.
<Rotation X:>	Output	Rotation around the X axis.

Field	Option	Description
<Rotation Y:>	Output	Rotation around the Y axis.
<Rotation Z:>	Output	Rotation around the Z axis.
<Scale:>	Output	Scale factor used in transformation. Either true scale or ppm.

Next step

PAGE (F6) changes to the **Rotn Origin** page. Refer to paragraph "DET C SYS Transformation Results, Rotn Origin page".

**DET C SYS
Transformation
Results,
Rotn Origin page**

Description of fields

Field	Option	Description
<Transf Model:>	Output	Classic 3D transformation model used for the transformation as defined in DET C SYS Configuration, Classic 3D page.
<Rot Orig X:>	Output	Available for <Transf Model: Molodensky-Bad>. Position in the X direction of the origin of rotation.
<Rot Orig Y:>	Output	Available for <Transf Model: Molodensky-Bad>. Position in the Y direction of the origin of rotation.
<Rot Orig Z:>	Output	Available for <Transf Model: Molodensky-Bad>. Position in the Z direction of the origin of rotation.

Next step

CONT (F1) returns to **DET C SYS Step 4: Check Residuals**.

40 Determine Coordinate System - One Point Localisation

40.1 Accessing Determine Coordinate System - One Point Localisation

Access step-by-step

Step	Description
1.	Refer to "38.2 Accessing Determine Coordinate System" to access DET C SYS Determine Coord System Begin.
2.	Select <Method: One Pt Localistn> .
3.	CONT (F1) to access DET C SYS Step 1: Choose Transform Type.

DET C SYS Step 1: Choose Transform Type

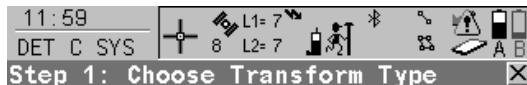

Transform Name: **New Coord System**
 Transform Type: **Classic 3D**
 Height Mode : **Ellipsoidal**



CONT (F1)

To confirm the selections and to continue with the subsequent screen.

Description of fields

Field	Option	Description
<Transfrm Name:>	User input	A unique name for the coordinate system. The name may be up to 16 characters in length and may include spaces.
<Transfrm Type:>	Onestep , Twostep or Classic 3D	The type of transformation to be used when determining a coordinate system.
<Height Mode:>	Orthometric or Ellipsoidal	The height mode to be used in the determination of a coordinate system

Next step

IF	THEN
<Transfrm Type: Onestep>	CONT (F1) to access DET C SYS Step 2: Choose Parameters . Refer to "40.2 Determine Coordinate System - Onestep Transformation".
<Transfrm Type: Twostep>	CONT (F1) to access DET C SYS Step 2: Choose Parameters . Refer to "40.3 Determine Coordinate System - Twostep Transformation".
<Transfrm Type: Classic 3D>	CONT (F1) to access DET C SYS Step 2: Choose Parameters . Refer to "40.4 Determine Coordinate System - Classic 3D Transformation".



<Azimuth:> is used throughout this chapter. This should always be considered to also mean <Bearing:>.

40.2

Determine Coordinate System - Onestep Transformation

Access step-by-step

Step	Description
1.	Refer to "40.1 Accessing Determine Coordinate System - One Point Localisation" to access DET C SYS Step 1: Choose Transform Type .
2.	DET C SYS Step 1: Choose Transform Type <Transform Type: Onestep>
3.	CONT (F1) to access DET C SYS Step 2: Choose Parameters .

DET C SYS

Step 2: Choose Parameters

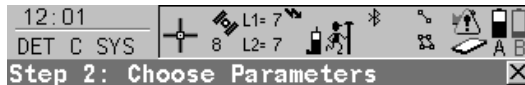

Geoid Mode1 : <None>



CONT (F1)

To confirm the selections and to continue with the subsequent screen.

Description of fields

Field	Option	Description
<Geoid Model:>	Choicelist	The geoid model to be used in the transformation. Geoid models from MANAGE Geoid Models can be selected.

Next step

CONT (F1) continues to **DET C SYS Step 3: Choose Common Point**.

DET C SYS Step 3: Choose Common Point

11:51
DET C SYS

Step 3: Choose Common Point

Match Type : Pos Only

WGS84 Point : 100

Known Point : 100

Match Height : Yes

WGS84 Point : 200

Known Point : 200

Q1 a ↑

CONT SURVY

CONT (F1)

To confirm the selections and to continue with the subsequent screen.

SURVY (F5)

Available for <WGS84 Point:> being highlighted. To manually occupy a point and store it in <WGS84 Pts Job:>.

Description of fields

Field	Option	Description
<Match Type:>		How the horizontal and vertical shifts of the transformation should be computed.
	Pos & Height	Position and height are taken from the same pair of matching points.
	Pos Only	Position is taken from one pair of matching points. The height can be taken from another pair of matching points.
<WGS84 Point:>	Choicelist	The point ID of the horizontal and/or vertical control point chosen from <WGS84 Pts Job:>. All WGS 1984 points from MANAGE Data: Job Name can be selected.
<Known Point:>	Choicelist	The point ID of the horizontal and/or vertical control point chosen from <Local Pts Job:>. All local points from MANAGE Data: Job Name can be selected.
<Match Height:>	Yes or No	Available for <Match Type: Pos Only>. Activates the determination of the vertical shift from a separate pair of matching points.

Next step

CONT (F1) continues to **DET C SYS Step 4: Determine Rotation.**

DET C SYS

Step 4: Determine Rotation

This screen contains different fields, depending on the **<Method:>** selected. The explanations for the softkeys given below are valid as indicated.



Rotation : 0.000 g



CONT (F1)

To confirm the selections and to continue with the subsequent screen.

INV (F2)

Available for **<Method: Two WGS84 Points>** and **<Method: User Entered>**. To compute an azimuth between two local points. Refer to "40.5 Computing Required Azimuth".

SURVY (F5)

Available when **<Point 1:>** or **<Point 2:>** are highlighted for **<Method: Two WGS84 Points>** or when **<WGS84 Point:>** is highlighted for **<Method: Convergence Angle>**. To manually occupy a point and store it in **<WGS84 Pts Job:>**.

Description of common fields

Field	Option	Description
<Method:>	Use WGS84 North, User Entered, Convergence Angle or Two WGS84 Points	Method by which the rotation angle for the transformation is determined.

For <Method: Use WGS84 North>**Description of fields**

Field	Option	Description
<Rotation:>	Output	Transformation will be rotated to North as defined by the WGS 1984 datum. North is 0.00000°.

For <Method: User Entered>**Description of fields**

Field	Option	Description
<Rotation:>	User input	Allows the orientation of the transformation to be manually typed in or calculated in DET C SYS Compute Required Azimuth .

For <Method: Convergence Angle>

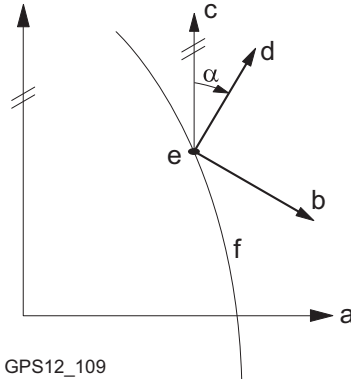

GPS12_109

- a WGS 1984 coordinate system
- b Local coordinate system, <Coord System:>
- c Geodetic North
- d Grid North
- e Point on WGS 1984 datum, <WGS84 Point:>
- f Meridian
- α Convergence angle, <Rotation:>

Description of fields

Field	Option	Description
<Coord System:>	Choicelist	Coordinate system to provide the direction of grid North in the area where the control point used for determining the local coordinate system, is located. All coordinate systems from Main Menu: Manage...\Coordinate Systems can be selected.
<WGS84 Point:>	Choicelist	WGS 1984 point of which the convergence angle will be calculated. All points from <WGS84 Pts Job:> selected in DET C SYS Determine Coord System Begin can be selected.

Field	Option	Description
<Rotation:>	Output	The rotation of the transformation calculated as 0.00000° minus the computed convergence angle. The field is updated as <Coord System:> and <WGS84 Point:> are changed.

For <Method: Two WGS84 Points>

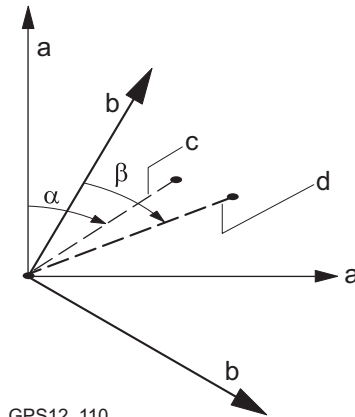

GPS12_110

- a WGS 1984 coordinate system
- b Local coordinate system
- c Line between two WGS 1984 points.
- d Line between two local points
- α Azimuth of two WGS 1984 points, <Azimuth:>
- β Known azimuth or azimuth of two local points, <Reqd Azimuth:>

Description of fields

Field	Option	Description
<Point 1:>	Choicelist	First point to use for computation of <Azimuth:>. All points from <WGS84 Pts Job:> chosen in DET C SYS Determine Coord System Begin can be selected.
<Point 2:>	Choicelist	Second point to use for computation of <Azimuth:>. All points from <WGS84 Pts Job:> chosen in DET C SYS Determine Coord System Begin can be selected.
<Azimuth:>	Output	Computed azimuth between <Point 1:> and <Point 2:>.
<Reqd Azimuth:>	User input	The required grid azimuth, computed between two local points. Refer to "40.5 Computing Required Azimuth".
<Rotation:>	Output	The rotation of the transformation calculated as <Reqd Azimuth> minus <Azimuth>. The field is updated as <Point 1:>, <Point 2:> and <Reqd Azimuth:> are changed.

Next step

CONT (F1) continues to **DET C SYS Step 5: Determine Scale**.

DET C SYS

Step 5: Determine Scale

This screen contains different fields, depending on the **<Method:>** selected. The explanations for the softkeys given below are valid as indicated. The scale is calculated using the formula $(r + h)/r$ where r is the distance from the centre of the ellipsoid to the WGS 1984 point selected in **DET C SYS Step 3: Choose Common Point** and h is the height of this point above the WGS 1984 ellipsoid.

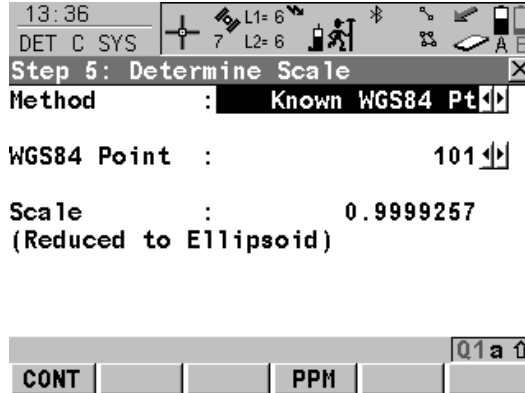

CONT (F1)

To confirm the selections and to continue with the subsequent screen.

SCALE (F4) or PPM (F4)

To switch between **<Scale:>** displaying the true scale and displaying the ppm.

SURVY (F5)

Available for **<Method: Known WGS84 Pt:>** when **<WGS84 Point:>** is highlighted. To manually occupy a point and store it in **<WGS84 Pts Job:>**.

Description of common fields

Field	Option	Description
<Method:>	User Entered, Known WGS84 Pt or Known WGS84 Ht	Method of determining the scale factor of the transformation.

For <Method: User Entered>

Description of fields

Field	Option	Description
<Scale:>	User input	Allows the scale factor to be typed in manually.

For <Method: Known WGS84 Pt>

Description of fields

Field	Option	Description
<WGS84 Point:>	Choicelist	WGS 1984 point from which the scale factor will be calculated. The scale factor is calculated using the height of the known WGS 1984 point. All points from the <WGS84 Pts Job:> chosen in DET C SYS Determine Coord System Begin can be selected.
<Scale:>	Output	The calculated scale factor.

For <Method: Known WGS84 Ht>

Description of fields

Field	Option	Description
<Known Height:>	User input	The WGS 1984 height of a point can be typed in. The scale factor is calculated using this height.
<Scale:>	Output	The calculated scale factor.

Next step

CONT (F1) continues to **DET C SYS Step 6: Store Coord System.**

**DET C SYS
Step 6: Store Coord
System**

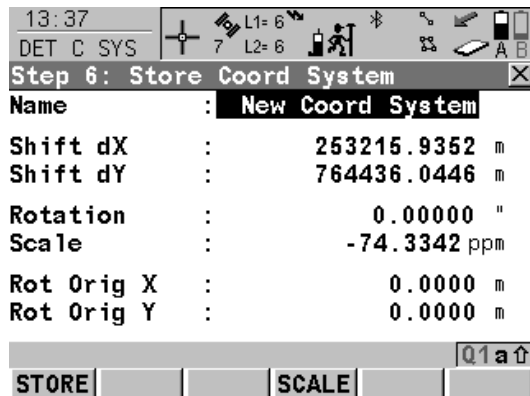

STORE (F1)

To store the coordinate system to the DB-X, attach the system to **<WGS84 Pts Job:>** that was selected in **DET C SYS Determine Coord System Begin** and return to **GPS1200 Main Menu.**

SCALE (F4) or PPM (F4)

To switch between **<Scale:>** displaying the true scale and displaying the ppm.

Description of fields

Field	Option	Description
<Name:>	User input	A unique name for the coordinate system. The name may be up to 16 characters in length and may include spaces.
<Shift dX:>	Output	Shift in X direction.
<Shift dY:>	Output	Shift in Y direction.
<Rotation:>	Output	Rotation of transformation.

Field	Option	Description
<Scale:>	Output	Scale factor of transformation.
<Rot Orig X:>	Output	Position in the X direction of the origin of rotation.
<Rot Orig Y:>	Output	Position in the Y direction of the origin of rotation.

Next step

STORE (F1) stores the coordinate system and returns to **GPS1200 Main Menu**.

40.3 Determine Coordinate System - Twostep Transformation

40.3.1 Twostep Transformation

Access step-by-step

Step	Description
1.	Refer to "40.1 Accessing Determine Coordinate System - One Point Localisation" to access DET C SYS Step 1: Choose Transform Type .
2.	DET C SYS Step 1: Choose Transform Type <Transfrm Type: Twostep>
3.	CONT (F1) to access DET C SYS Step 2: Choose Parameters .

DET C SYS

Step 2: Choose Parameters

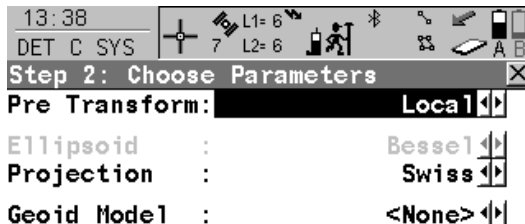

CONT (F1)

To confirm the selections and to continue with the subsequent screen.

Description of fields

Field	Option	Description
<Pre Transform:>	Choicelist	The pre-transformation to be used for the preliminary 3D transformation. All 3D transformations from MANAGE Transformations can be selected.
<Ellipsoid:>	Choicelist Output	The ellipsoid to be used in the transformation. All ellipsoids from MANAGE Ellipsoids can be selected. The ellipsoid being used by a fixed projection when selected in <Projection:>.
<Projection:>	Choicelist	The projection to be used in the transformation. All projections from MANAGE Projections can be selected.
<Geoid Model:>	Choicelist	The geoid model to be used in the transformation. Geoid models from MANAGE Geoid Models can be selected.

Next step

CONT (F1) continues to **DET C SYS Step 3: Choose Common Point**.

DET C SYS
Step 3: Choose
Common Point

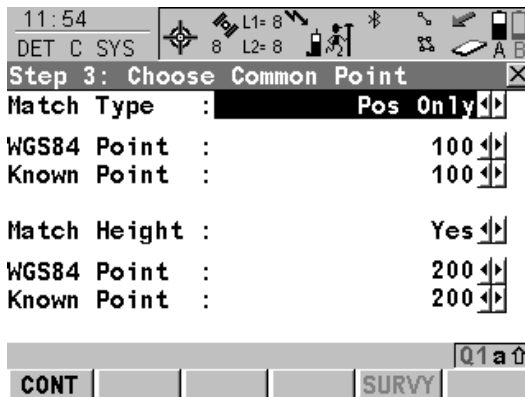

CONT (F1)

To confirm the selections and to continue with the subsequent screen.

SURVY (F5)

Available for **<WGS84 Point:>** being highlighted. To manually occupy a point and store it in **<WGS84 Pts Job:>**.

Description of fields

Field	Option	Description
<Match Type:>		How the horizontal and vertical shifts of the transformation should be computed.
	Pos & Height	Position and height are taken from the same pair of matching points.
	Pos Only	Position is taken from one pair of matching points. The height can be taken from another pair of matching points.

Field	Option	Description
<WGS84 Point:>	Choicelist	The point ID of the horizontal and/or vertical control point chosen from <WGS84 Pts Job:>. All WGS 1984 points from MANAGE Data: Job Name can be selected.
<Known Point:>	Choicelist	The point ID of the horizontal and/or vertical control point chosen from <Local Pts Job:>. All local points from MANAGE Data: Job Name can be selected.
<Match Height:>	Yes or No	Available for <Match Type: Pos Only>. Activates the determination of the vertical shift from a separate pair of matching points.

Next step

CONT (F1) continues to **DET C SYS Step 4: Determine Rotation**.

DET C SYS

Step 4: Determine Rotation

This screen contains different fields, depending on the **<Method:>** selected. The explanations for the softkeys given below are valid as indicated.

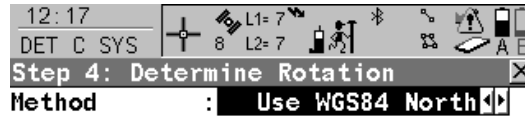

Rotation : 0.000 g



CONT (F1)

To confirm the selections and to continue with the subsequent screen.

INV (F2)

Available for **<Method: Two WGS84 Points>** and **<Method: User Entered>**. To compute an azimuth between two local points. Refer to "40.5 Computing Required Azimuth".

SURVY (F5)

Available when **<Point 1:>** or **<Point 2:>** are highlighted for **<Method: Two WGS84 Points>** or when **<WGS84 Point:>** is highlighted for **<Method: Convergence Angle>**. To manually occupy a point and store it in **<WGS84 Pts Job:>**.

Description of common fields

Field	Option	Description
<Method:>	Use WGS84 North, User Entered, Convergence Angle or Two WGS84 Points	Method by which the rotation angle for the transformation is determined.

For <Method: Use WGS84 North>

Description of fields

Field	Option	Description
<Rotation:>	Output	Transformation will be rotated to North as defined by the WGS 1984 datum. North is 0.00000°.

For <Method: User Entered>

Description of fields

Field	Option	Description
<Rotation:>	User input	Allows the orientation of the transformation to be manually typed in or calculated in DET C SYS Compute Required Azimuth.

For <Method: Convergence Angle>

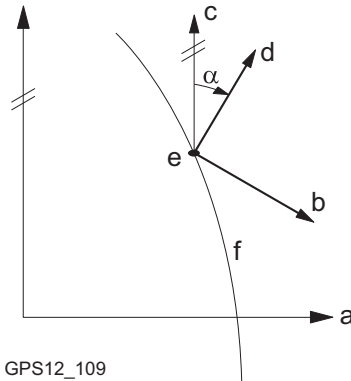

GPS12_109

- a WGS 1984 coordinate system
- b Local coordinate system, <Coord System:>
- c Geodetic North
- d Grid North
- e Point on WGS 1984 datum, <WGS84 Point:>
- f Meridian
- α Convergence angle, <Rotation:>

Description of fields

Field	Option	Description
<Coord System:>	Choicelist	Coordinate system to provide the direction of grid North in the area where the control point used for determining the local coordinate system, is located. All coordinate systems from Main Menu: Manage...\Coordinate Systems can be selected.
<WGS84 Point:>	Choicelist	WGS 1984 point of which the convergence angle will be calculated. All points from <WGS84 Pts Job:> chosen in DET C SYS Determine Coord System Begin can be selected.

Field	Option	Description
<Rotation:>	Output	The rotation of the transformation calculated as 0.00000° minus the computed convergence angle. The field is updated as <Coord System:> and <WGS84 Point:> are changed.

For <Method: Two WGS84 Points>

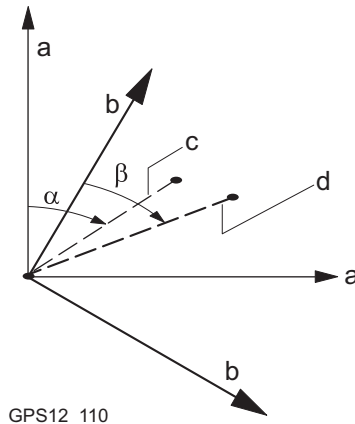

- a WGS 1984 coordinate system
- b Local coordinate system
- c Line between two WGS 1984 points.
- d Line between two local points
- α Azimuth of two WGS 1984 points, <Azimuth:>
- β Known azimuth or azimuth of two local points, <Reqd Azimuth:>

Description of fields

Field	Option	Description
<Point 1:>	Choicelist	First point to use for computation of <Azimuth:>. All points from <WGS84 Pts Job:> chosen in DET C SYS Determine Coord System Begin can be selected.
<Point 2:>	Choicelist	Second point to use for computation of <Azimuth:>. All points from <WGS84 Pts Job:> chosen in DET C SYS Determine Coord System Begin can be selected.
<Azimuth:>	Output	Computed azimuth between <Point 1:> and <Point 2:>.
<Reqd Azimuth:>	User input	The required grid azimuth, computed between two local points. Refer to "40.5 Computing Required Azimuth".
<Rotation:>	Output	The rotation of the transformation calculated as <Reqd Azimuth> minus <Azimuth>. The field is updated as <Point 1:>, <Point 2:> and <Reqd Azimuth:> are changed.

Next step

CONT (F1) continues to **DET C SYS Step 5: Determine Scale.**

DET C SYS

Step 5: Determine Scale

This screen contains different fields, depending on the **<Method:>** selected. The explanations for the softkeys given below are valid as indicated. The scale is calculated using the formula $(r + h)/r$ where r is the radius of the ellipsoid at the position of the WGS 1984 point selected in **DET C SYS Step 3: Choose Common Point** and h is the height of this point above the local ellipsoid.

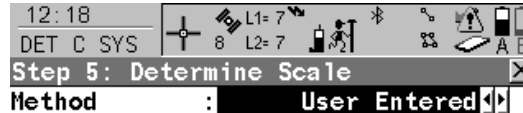

Combined SF : 0.9999257



Description of fields

Field	Option	Description
<Method:>	User Entered or Compute CSF	The default method for determining the Combined Scale Factor to be used in the transformation process.

CONT (F1)

To confirm the selections and to continue with the subsequent screen.

GRID (F2)

Available for **<Method: Compute CSF>**. To compute the grid scale factor. Accesses **DET C SYS Compute Grid Scale Factor**. Refer to "40.3.2 Computing the Grid Scale Factor".

HIGHT (F3)

Available for **<Method: Compute CSF>**. To compute the height scale factor. Accesses **DET C SYS Compute Height Scale Factor**. Refer to "40.3.3 Computing the Height Scale Factor".

Field	Option	Description
<Grid SF:>	Output	Available for <Method: Compute CSF>. The grid scale factor as computed in DET C SYS Compute Grid Scale Factor .
<Height SF:>	Output	Available for <Method: Compute CSF>. The height scale factor as computed in DET C SYS Compute Height Scale Factor .
<Combined SF:>	User input	The combined scale factor of the transformation. Available for <Method: User Entered>. The scale factor can be typed in.
	Output	Available for <Method: Compute CSF>. The product of the grid scale factor and the height scale factor.

Next step

CONT (F1) continues to **DET C SYS Step 6: Store Coord System**.

DET C SYS
Step 6: Store Coord
System

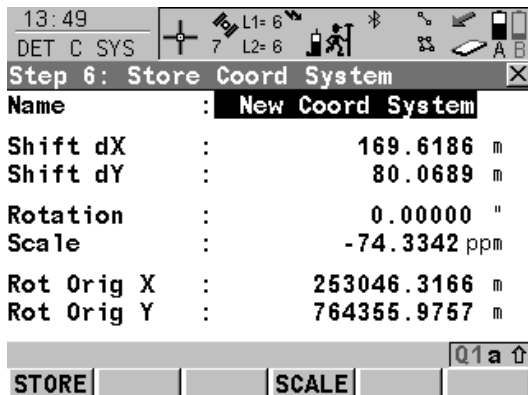

STORE (F1)

To store the coordinate system to the DB-X, attach the system to **<WGS84 Pts Job:>** that was selected in **DET C SYS Determine Coord System Begin** and return to **GPS1200 Main Menu**.

SCALE (F4) or PPM (F4)

To switch between **<Scale:>** displaying the true scale and displaying the ppm.

Description of fields

Field	Option	Description
<Name:>	User input	A unique name for the coordinate system. The name may be up to 16 characters in length and may include spaces.
<Shift dX:>	Output	Shift in X direction.
<Shift dY:>	Output	Shift in Y direction.
<Rotation:>	Output	Rotation of transformation.
<Scale:>	Output	Scale factor of transformation.
<Rot Orig X:>	Output	Position in the X direction of the origin of rotation.
<Rot Orig Y:>	Output	Position in the Y direction of the origin of rotation.

Next step

STORE (F1) stores the coordinate system and returns to **GPS1200 Main Menu**.

40.3.2

Computing the Grid Scale Factor

Description

Calculates the grid scale factor. The grid scale factor is the scale factor of the point chosen relative to the projection being used.

Access step-by-step

Step	Description
1.	Refer to "40.1 Accessing Determine Coordinate System - One Point Localisation" to access DET C SYS Step 1: Choose Transform Type .
2.	Select <Transform Type: Twostep> .
3.	Continue to DET C SYS Step 5: Determine Scale .
4.	Select <Method: Compute CSF> .
5.	GRID (F2) to access DET C SYS Compute Grid Scale Factor .

DET C SYS Compute Grid Scale Factor

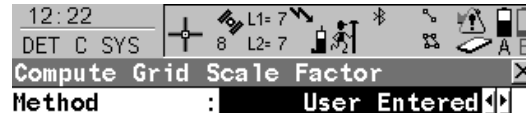

Grid SF : 1.0000010



CONT (F1)

To confirm the selections and return to the screen from where this screen was accessed.

Description of fields

Field	Option	Description
<Method:>	<p>User Entered</p> <p>Known Local Pt</p>	<p>Method by which the grid scale factor is to be calculated.</p> <p>Grid scale factor can be manually typed in.</p> <p>Grid scale factor is computed using the position of a known local point.</p>
<Local Point:>	Choicelist	Available for <Method: Known Local Pt >. The point ID of the point chosen from <Local Pts Job:> from which the grid scale factor is computed using the projection selected in DET C SYS Step 2: Choose Parameters . All local points from MANAGE Data: Job Name can be selected.
<Grid SF:>	<p>User input</p> <p>Output</p>	<p>The grid scale factor.</p> <p>Available for <Method: User Entered>. To type in the grid scale factor.</p> <p>Available for <Method: Known Local Pt>. The computed grid scale factor.</p>

Next step

CONT (F1) returns to **DET C SYS Step 5: Determine Scale**.

40.3.3

Computing the Height Scale Factor

Description

Calculates the height scale factor of the point chosen.

Access step-by-step

Step	Description
1.	Refer to "40.1 Accessing Determine Coordinate System - One Point Localisation" to access DET C SYS Step 1: Choose Transform Type .
2.	Select <Transform Type: Twostep> .
3.	Continue to DET C SYS Step 5: Determine Scale .
4.	Select <Method: Compute CSF> .
5.	HIGHT (F3) to access DET C SYS Compute Height Scale Factor .

DET C SYS Compute Height Scale Factor

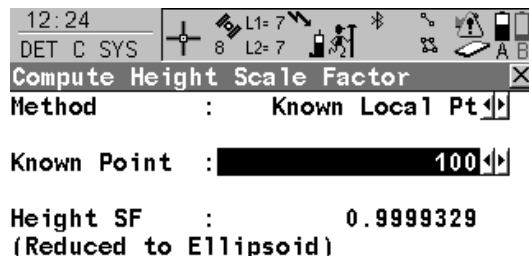

CONT (F1)

To confirm the selections and return to the screen from where this screen was accessed.

Description of fields

Field	Option	Description
<Method:>		Method by which the height scale factor is to be calculated.
	User Entered	Height scale factor can be manually typed in.
	Known Local Pt	Height scale factor is computed using the height of a known local point.
	Known Local Ht	Height scale factor is computed using an entered height value.
<Known Point:>	Choicelist	Available for <Method: Known Local Pt>. The point ID of the point chosen from <Local Pts Job:> from which the height scale factor is computed. All local points from MANAGE Data: Job Name can be selected.
<Known Height:>	User input	Available for <Method: Known Local Ht>. A known local height.
<Height SF:>	User input	The height scale factor. Available for <Method: User Entered>. To type in the height scale factor.
	Output	Available for <Method: Known Local Pt> and <Method: Known Local Ht>. The computed height scale factor.

Next step

CONT (F1) returns to **DET C SYS Step 5: Determine Scale.**

40.4

Determine Coordinate System - Classic 3D Transformation

Access step-by-step

Step	Description
1.	Refer to "40.1 Accessing Determine Coordinate System - One Point Localisation" to access DET C SYS Step 1: Choose Transform Type .
2.	DET C SYS Step 1: Choose Transform Type <Transfrm Type: Classic 3D>
3.	CONT (F1) to access DET C SYS Step 2: Choose Parameters .

DET C SYS

Step 2: Choose Parameters

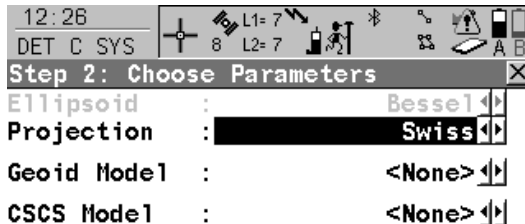

CONT (F1)

To confirm the selections and to continue with the subsequent screen.



Description of fields

Field	Option	Description
<Ellipsoid:>	Choicelist Output	The ellipsoid to be used in the transformation. All ellipsoids from MANAGE Ellipsoids can be selected. The ellipsoid being used by a fixed projection when selected in <Projection:>.
<Projection:>	Choicelist	The projection to be used in the transformation. All projections from MANAGE Projections can be selected.
<Geoid Model:>	Choicelist	The geoid model to be used in the transformation. Geoid models from MANAGE Geoid Models can be selected.
<CSCS Model:>	Choicelist	The CSCS model to be used in the transformation. All CSCS models from MANAGE CSCS Models can be selected.

Next step

CONT (F1) continues to **DET C SYS Step 3: Choose Common Point**.

DET C SYS
Step 3: Choose
Common Point

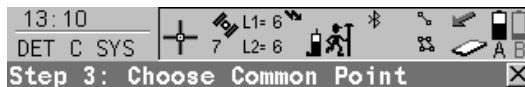

WGS84 Point : ██████████ 101
Known Point : 101

Local Height : Use WGS84 Pt Ht



CONT (F1)

To confirm the selections and to continue with the subsequent screen.

SURVY (F5)

To manually occupy a point and store it in <WGS84 Pts Job:>.

Description of fields

Field	Option	Description
<WGS84 Point:>	Choicelist	The point ID of the control point chosen from <WGS84 Pts Job:>. All WGS 1984 points from MANAGE Data: Job Name can be selected.
<Known Point:>	Choicelist	The point ID of the control point chosen from <Local Pts Job:>. All local points from MANAGE Data: Job Name can be selected.
<Local Height:>	Use WGS84 Pt Ht or Use Local Pt Ht	The source of the height information to use in the transformation.

Next step

CONT (F1) continues to **DET C SYS Step 4: Store Coord System.**

**DET C SYS
Step 4: Store Coord
System**



Name : **New Coord System**

Shift dX : **-643.6830 m**

Shift dY : **-10.9948 m**

Shift dZ : **-370.9894 m**

STORE (F1)

To store the coordinate system to the DB-X, attach the system to <**WGS84 Pts Job**> that was selected in **DET C SYS Determine Coord System Begin** and return to **GPS1200 Main Menu.**



COORD (F2)

To view other coordinate types.

Description of fields

Field	Option	Description
<Shift dX:>	Output	Shift in X direction.
<Shift dY:>	Output	Shift in Y direction.
<Shift dZ:>	Output	Shift in Z direction.

Next step

STORE (F1) stores the coordinate system and returns to **GPS1200 Main Menu.**

40.5

Computing Required Azimuth

Description

Available for **<Method: Two WGS84 Points>** and **<Method: User Entered>** in **DET C SYS Step 4: Determine Rotation**.

Allows two local points to be chosen from **<Local Pts Job:>** selected in **DET C SYS Determine Coord System Begin** between which the required azimuth will be computed. This azimuth is then used with an azimuth computed between two WGS 1984 points chosen from **<WGS84 Pts Job:>** selected in **DET C SYS Determine Coord System Begin**, to calculate the rotation of the transformation.

The computed required azimuth appears in the **<Reqd Azimuth:>** field for **<Method: Two WGS84 Points>** and the **<Rotation:>** field for **<Method: User Entered>** in **DET C SYS Step 4: Determine Rotation**.

Compute azimuth step-by-step

Step	Description
1.	Refer to "40.1 Accessing Determine Coordinate System - One Point Localisation" to access DET C SYS Step 1: Choose Transform Type .
2.	Select <Transfrm Type: Onestep> or <Transfrm Type: Twostep> .
3.	Continue to DET C SYS Step 4: Determine Rotation .
4.	Select <Method: Two WGS84 Points> or <Method: User Entered> .
5.	INV (F2) to access DET C SYS Compute Required Azimuth .
6.	DET C SYS Compute Required Azimuth <From:> The point ID of the first known point for the azimuth calculation. <To:> The point ID of the second known point for the azimuth calculation. Select the points stored in the <Local Pts Job:> .

Step	Description
7.	CONT (F1) to calculate the required azimuth and return to DET C SYS Step 4: Determine Rotation.

41

Reference Line

41.1

Overview

Description

The Reference Line application program can be used to set out or measure points relative to a reference line or a reference arc.

Reference line tasks

The Reference Line application program can be used for the following tasks:

- Measuring to a line/arc where the coordinates of a target point can be calculated from its position relative to the defined reference line/arc.
- Staking to a line/arc where the position of a target point is known and instructions to locate the point are given relative to the reference line/arc.
- Gridstaking a line/arc where a grid can be staked relative to a reference line/arc.

Other functionality available includes:

- Offsetting the reference line/arc horizontally or vertically. The radius of the arc changes with the horizontal offset.
- Shifting the reference line with parallel offsets or rotating to match predefined setting out instructions.
- Measuring points and staking points on slopes related to a reference line/arc.

Activating the application program

The Reference Line application program must be activated via a licence key. Refer to "30 Tools...\Licence Keys" for information on how to activate the application program.



Measuring and staking out of points is possible for **<R-Time Mode: Rover>** and **<R-Time Mode: None>**.

Point types

Reference lines/arcs can be created from points stored as:

- WGS 1984 geodetic
- Local grid

Heights and positions are always taken into account. Points must have full coordinate triplets.

Properties of measured points

The properties stored with staked points are:

- Class: Either **MEAS** or **NAV** depending on the position status when the staked point was occupied.
 - Sub class: **GPS Fixed**, **GPS Code Only**, **GNSS Fixed** or **GNSS Code Only**
 - Source: **RefLine (Grid)**, **RefLine (Meas)** or **RefLine (Stake)**
 - Instrument source: **GPS**
-

Deleting points

A point that is used to define a reference line/arc can be deleted. A reference line/arc can still be used if one or more points defining the reference line/arc have been deleted. Within **REFLINE Edit Reference Line** and **REFLINE Edit Reference Arc** the deleted point field is shown in grey. Within MapView the reference line is still displayed but the deleted point or points is/are not.

Terms

Reference point: The term reference point is used in this chapter to refer to the point from which the perpendicular offset from the reference line/arc, to the target point, is measured. Refer to paragraph "Defining a reference line/arc" and the diagrams for further explanation.

Target point:	The design point. <ul style="list-style-type: none"> • For measuring to a reference line, this is the point with the coordinates of the current position and the designed or calculated height. • For staking or grid staking to a reference line, this is the point to be staked.
Measured point:	The current position.

Defining a reference line/arc

A reference line can be defined in the following ways:

- Two known points
- One known point, an azimuth, a distance and a gradient
- One known point, an azimuth, a distance and a difference in height

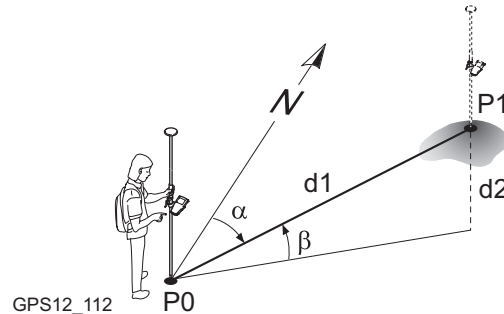

- P0 Start point
- P1 End point
- $d1$ Known distance
- $d2$ Difference in height, ΔHt
- α Azimuth
- β Elevation angle between the start point and the end point

A reference arc can be defined in the following ways:

- Two known points and a radius
- Three known points

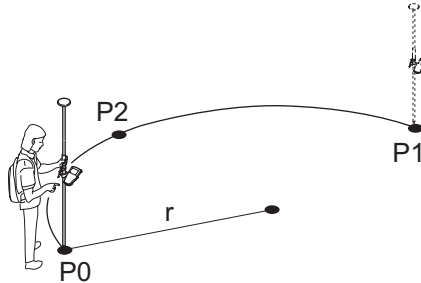

GPS12_113

P0 Start point
 P1 End point
 P2 Known point
 r Radius of arc

Defining chainage



The chainage of the start point of a reference line/arc can be defined.

Coordinate systems



It is possible to define an arc that has an opening angle of more than 180° .

It is possible to use a valid coordinate system but have the line or part of the line lying outside of the projection or CSCS model being used.

In these cases the output fields of all prompts relating to the difference in coordinates between the point being staked and the current position are shown as -----.



<Azimuth:> is used throughout this chapter. This should always be considered to also mean **<Bearing:>**.

When describing screens with a title that changes depending on whether a line or an arc was chosen, the terms line and arc are replaced by XX.

Direction of values

The following diagram shows the direction of positive and negative values for distance and height differences between the target point and the reference point for reference lines.

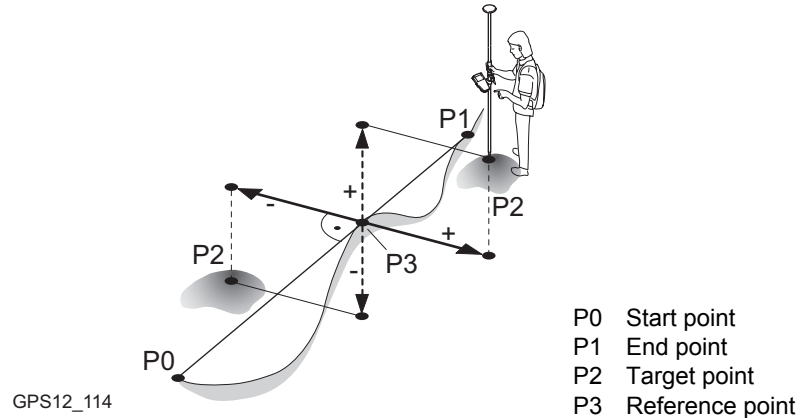

41.2

Accessing Reference Line

Access

Select **Main Menu: Programs...\Reference Line**.

OR

Press **PROG**. Highlight **Reference Line**. **CONT (F1)**. Refer to "36.2 Accessing the Application Programs Menu" for information on the **PROG** key.

OR

Press a hot key configured to access the screen **REFLINE Reference Line/Arc Begin**. Refer to "6.1 Hot Keys" for information on hot keys.

OR

Press **USER**. Refer to "6.2 USER Key" for information on the **USER** key.

REFLINE Reference Line/Arc Begin

11:53
REFLINE
Reference Line/Arc Begin
Control Job : Job1
Job : Job2
Coord System : Local
Codelist : <None>
Config Set : RT_Rov
Antenna : AX1202 Pole
CONT CONF CSYS

CONT (F1)

To confirm the selections and to continue with the subsequent screen.

CONF (F2)

To configure the Reference Line application program. Refer to "41.3 Configuring Reference Line".

CSYS (F6)

To select a different coordinate system.

Description of fields

Field	Option	Description
<Control Job:>	Choicelist	The original points to be staked and the reference lines/arcs are stored in this job. All jobs from Main Menu: Manage...\Jobs can be selected.
<Job:>	Choicelist	The active job. All jobs from Main Menu: Manage...\Jobs can be selected. Points which are occupied after staking out are stored in this job. The original points to be staked are not copied to this job.
<Coord System:>	Output	The coordinate system currently attached to the selected <Job:>.
<Codelist:>	Choicelist	No codes are stored in the selected <Job:>. All codelists from Main Menu: Manage...\Codelists can be selected.
	Output	Codes have already been stored in the selected <Job:>. If codes had been copied from a System RAM codelist, then the name of the codelist is displayed. If codes have not been copied from a System RAM codelist but typed in manually, then the name of the active job is displayed.
<DTM Job:>	Choicelist	Available for <Heights: Use DTM Model> in REFLINE Configuration, Heights page. To select a DTM to be staked. Heights are then staked out relative to the selected DTM.

Field	Option	Description
<Config Set:>	Choicelist	The active configuration set. All configuration sets from Main Menu: Manage... \Configuration Sets can be selected. Configuration sets with < R-Time Mode: Reference > cannot be used in the Reference Line application program.
<Antenna:>	Choicelist	The antenna currently defined to be used in the selected configuration set. All antennas from Main Menu: Manage... \Antennas can be selected.

Next step

IF the Reference Line application program	THEN
is to be accessed	CONT (F1) accepts the changes and accesses the Reference Line application program. Refer to "41.4 Managing Reference Lines/Arcs".
is to be configured	CONF (F2) . Refer to "41.3 Configuring Reference Line".

41.3 Configuring Reference Line

Description

Allows options to be set which are used within the Reference Line application program. These settings are stored within the configuration set.

Access step-by-step

Step	Description
1.	Refer to "41.2 Accessing Reference Line" to access REFLINE Reference Line/Arc Begin .
2.	CONF (F2) to access REFLINE Configuration .

REFLINE Configuration, General page

This screen consists of the **General** page, the **Checks** page, the **Heights** page and the **Logfile** page. The explanations for the softkeys given below are valid as indicated.

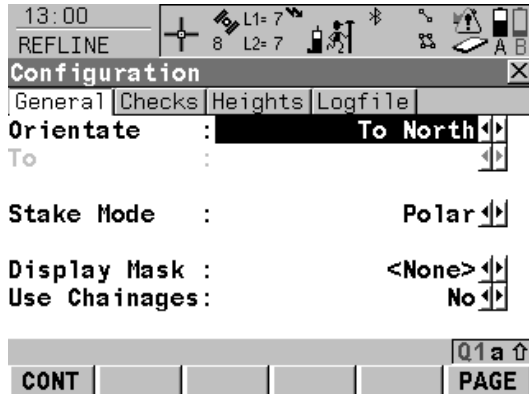

CONT (F1)

To accept changes and return to the screen from where this screen was accessed.

DMASK (F3)

To edit the display mask currently being displayed. Accesses **CONFIGURE Define Display Mask n**. Available when **<Display Mask:>** is highlighted on **General** page. Refer to "19.2 Display Settings".

PAGE (F6)

To change to another page on this screen.

SHIFT ABOUT (F5)

To display information about the application program name, the version number, the date of the version, the copyright and the article number.

Description of fields

Field	Option	Description
<Orientate:>		The reference direction to be used to stakeout points. The stakeout elements and the graphical display shown in the Reference Line application program are based on this selection.
	To North	The North direction shown in the graphical display based on the active coordinate system.
	To Sun	The position of the sun calculated from the current position, the time and the date.
	To Last Point	Timewise the last recorded point. If no points are yet staked, <Orientate: To North> is used for the first point to be staked.
	To Point(Stake)	A point from <Control Job:> selected in REFLINE Reference Line/Arc Begin .
	To Point(Store)	A point from <Job:> selected in REFLINE Reference Line/Arc Begin .
	To Line/Arc	The direction of the orientation is parallel to the reference line or the reference arc.

Field	Option	Description
	To Arrow	The direction of the orientation is from the current position to the point to be staked. The graphical display shows an arrow pointing in the direction of the point to be staked.
<To:>	Choicelist	Available for <Orientate: To Point(Stake)> and <Orientate: To Point(Store)>. To select the point to be used for orientation. Refer to "9.2 Accessing Data Management" for information on creating, editing and deleting a known point.
<Stake Mode:>	Polar Orthogonal	The method of staking out. The direction from the orientation reference, the horizontal distance and the cut/fill is displayed. The distance forwards/backwards to the point, the distance right/left to the point and the cut/fill is displayed.
<Display Mask:>	Choicelist	The user defined display mask to be shown in REFLINE XX Points . All display masks of the active configuration set defined in CONFIGURE Display Settings can be selected.
<Use Chainages:>	Yes or No	Activates the use of chainages within the reference line application program.
<Chain Format:>	+123456.789	Available for <Use Chainages: Yes>. Selects display format for all chainage information fields. Default chainage display form.

Field	Option	Description
	+123.4+56.789	Separator between tens and hundreds with additional decimal point.
	+123+456.789	Separator between hundreds and thousands.
	+1234+56.789	Separators between tens and hundreds.  The distance units <Int Ft/Inch (fi)> , <US Ft/Inch (ft)> , <Kilometres (km)> and <US Miles (mi)> are only supported by the first chainage format. All other chainage formats are restricted to the base units <Metre (m)> , <Int Ft (fi)> and <US Ft (ft)> .

Next step

PAGE (F6) changes to the **Checks** page. Refer to paragraph "REFLINE Configuration, Checks page".

REFLINE Configuration, Checks page

Description of fields

Field	Option	Description
<Pos Check:>	Yes or No	Allows a check to be made on the horizontal coordinate difference between the manually occupied staked point and the point to be staked. If the defined <Pos Limit:> is exceeded, the stakeout can be repeated, skipped or stored.

Field	Option	Description
<Pos Limit:>	User input	Available for <Pos Check: Yes>. Sets the maximum horizontal coordinate difference which is accepted in the position check.
<Height Check:>	Yes or No	Allows a check to be made on the vertical difference between the manually occupied staked point and the point to be staked. If the defined <Height Limit:> is exceeded, the stakeout can be repeated, skipped or stored.
<Height Limit:>	User input	Available for <Height Check: Yes>. Sets the maximum vertical difference accepted in the height check.
<Beep near Pt:>	Yes or No	The receiver beeps when the horizontal radial distance from the current position to the point to be staked is equal to or less than defined in <Dist from Pt:>.
<Dist from Pt:>	User input	Available for <Beep near Pt: Yes>. The horizontal radial distance from the current position to the point to be staked when a beep should be heard.

Next step

PAGE (F6) changes to the **Heights** page. Refer to paragraph "REFLINE Configuration, Heights page".

**REFLINE
Configuration,
Heights page**

Description of fields

Field	Option	Description
<Heights:>	Choicelist	Available if this screen was accessed from REFLINE Reference Line/Arc Begin . Depending on the task chosen this parameter controls the following: <ul style="list-style-type: none"> • When measuring to a line/arc, it determines the delta height value which is displayed when points are being measured. • When staking to or gridstaking a line/arc, it determines the height value to be staked out.
	Use Ref Line	Heights are computed along the reference line/arc.
	Use Start Point	Heights are computed relative to the height of the starting point.
	Use DTM Model	The stakeout heights is computed from the DTM being used.
	Output	Available unless this screen was accessed from REFLINE Reference Line/Arc Begin .
<Edit Height:>	No	The field <Height:> for the height of the current position is displayed in REFLINE Measure Points, Ref XX page and REFLINE Enter Offset Values and as <Ht:> in REFLINE XX Stakeout, Ref XX page and REFLINE +yyy.yy +xxx.xx, Ref XX page. The values for <Height:> and <Ht:> cannot be changed.

Field	Option	Description
	Yes	The field <Design Ht:> is displayed in REFLINE Measure Points, Ref XX page and REFLINE Enter Offset Values and as <D Ht:> in REFLINE XX Stakeout, Ref XX page and REFLINE +yyy.yy +xxx.xx, Ref XX page. The design height is the height of the point to be staked. The initial value is as configured in the <Heights:> field. The values for <Design Ht:> and <D Ht:> can be changed.

Next step

PAGE (F6) changes to the **Logfile** page. Refer to paragraph "REFLINE Configuration, Logfile page".

**REFLINE
Configuration,
Logfile page**
Description of fields

Field	Option	Description
<Write Logfile:>	Yes or No	To generate a logfile when the application program is exited. A logfile is a file to which data from an application program is written to. It is generated using the selected <Format File:> .
<File Name:>	Choicelist	Available for <Write Logfile: Yes> . The name of the file to which the data should be written. A logfile is stored in the \DATA directory of the active memory device. The data is always appended to the file.

Field	Option	Description
		Opening the choicelist accesses XX Logfiles where a name for a new logfile can be created and an existing logfile can be selected or deleted.
<Format File:>	Choicelist	Available for <Write Logfile: Yes> . A format file defines which and how data is written to a logfile. Format files are created using LGO. A format file must first be transferred from the CompactFlash card to the System RAM before it can be selected. Refer to "26 Tools...\Transfer Objects..." for information on how to transfer a format file. Opening the choicelist accesses MANAGE XX where an existing format file can be selected or deleted.

Next step

CONT (F1) returns to the screen from where this screen was accessed.

41.4

Managing Reference Lines/Arcs

41.4.1

Overview

Description

There are two ways by which a reference line/arc can be defined.

Manually Enter

- A reference line/arc can be defined by manually entering known parameters.
- The line is only temporary and is not stored once the Reference Line application program has been exited.
- Select **<Ref to Use: Manually Enter>** in **REFLINE Choose Task & Reference Line, Reference** page.
- Refer to "41.4.2 Manually Entering a Reference Line/Arc".

Select from Job

- Reference lines/arcs can be created, edited, stored and deleted in the **<Control Job:>**.
 - The reference lines/arcs can be recalled for use later.
 - Select **<Ref to Use: Select from Job>** in **REFLINE Choose Task & Reference Line, Reference** page.
 - Refer to "41.4.3 Selecting a Reference Line/Arc from the Job".
-

41.4.2

Manually Entering a Reference Line/Arc

Description

This screen allows a reference line/arc to be temporarily defined using a number of methods.

Access step-by-step

Step	Description
1.	Refer to "41.2 Accessing Reference Line" to access REFLINE Reference Line/Arc Begin .
2.	CONT (F1) to access REFLINE Choose Task & Reference Line, Reference page.
3.	REFLINE Choose Task & Reference Line, Reference page
	Select <Ref to Use: Manually Enter> .

REFLINE Choose Task & Refer- ence Line, Reference page

This screen contains the **Reference** page and the **Map** page. The explanations for the softkeys given below are valid as indicated. The fields available depend on the options chosen for **<Task:>** and **<Method:>** on this screen.

For all point fields, the MapView interactive display on the **Map** page can be used to select the desired point. Refer to "32 MapView Interactive Display Feature" for more information on the functionality and softkeys available.

09:40
REFLINE
Choose Task & Reference Line X
Reference | Map
Task : Measure to Line
Ref to Use : Manually Enter
Method : Pt/Brg/Dst/Grade
Start Point : 1000
Azimuth : 34°00'00"
Horiz Dist : 100.000 m
Grade : 1:0 hv
a ↑
CONT SLOPE OFFSET SURVY PAGE

CONT (F1)

To accept changes and continue with the subsequent screen.

SLOPE (F3)

To set a slope from a defined reference line/arc. Cut/Fill values can then be displayed to the slope when measurements are taken along the reference line/arc. Refer to "41.4.5 Defining Reference Line/Arc Slopes".

OFFSET (F4)

To define reference line/arc offsets, shifts, rotations, height offsets and DTM offsets. Refer to "41.4.4 Defining Reference Line/Arc Offsets".

SURVY (F5)

To manually occupy a point. Available when a point field is highlighted.

PAGE (F6)

To change to another page on this screen.

SHIFT CONF (F2)

To configure the reference line/arc. Refer to "41.3 Configuring Reference Line".

Description of fields

Field	Option	Description
<Task:>	Measure to Line or Measure to Arc	Defines the task to be performed. Calculates the coordinates of a point from it's position relative to the reference line/arc.

Field	Option	Description
	Stake to Line or Stake to Arc Gridstake Line or Gridstake Arc	<p>Allows points to be staked relative to the reference line/arc.</p> <p>Allows a grid to be staked out relative to the reference line/arc.</p>
<Chainage:>	User input	Available for <Use Chainages: Yes> in REFLINE Configuration, General page. Defines the chainage of the start point of the reference line/arc. The input format depends on the selection for <Chain Format:> in REFLINE Configuration, General page.
<Method:>	2 Points Pt/Brg/Dst/Grade Pt/Brg/Dst/ΔHt 3 Points 2 Points/Radius	<p>The method by which the reference line/arc will be defined.</p> <ul style="list-style-type: none"> For <Task: XX Line> <p>Uses two known points to define the reference line.</p> <p>Defines the reference line using a known point, a distance, an azimuth and the gradient of the line.</p> <p>The same as above but uses the difference in height instead of the gradient.</p> For <Task: XX Arc> <p>Defines the reference arc using three known points.</p> <p>Defines the reference arc with two known points and a known radius.</p>

Field	Option	Description
<Start Point:>	Choicelist	The start point of the reference line/arc. All points from REFLINE Data: Job Name can be selected.
<Second Point:>	Choicelist	Available for <Method: 3 Points>. The second point of the reference arc. All points from REFLINE Data: Job Name can be selected.
<End Point:>	Choicelist	Available for <Method: 2 Points>, <Method: 3 Points> and <Method: 2 Points/Radius>. The end point of the reference line/arc. All points from REFLINE Data: Job Name can be selected.
<Line Length:>	Output	Available for <Ref to Use: Manually Enter> with <Method: 2 Points>. The horizontal grid distance between <Start Point:> and <End Point:> of the line. ---- is displayed if the distance cannot be calculated.
<Azimuth:>	User input	Available for <Method: Pt/Brg/Dst/Grade> and <Method: Pt/Brg/Dst/ Δ Ht>. The azimuth of the reference line.
<Horiz Dist:>	User input	Available for <Method: Pt/Brg/Dst/Grade> and <Method: Pt/Brg/Dst/ Δ Ht>. The horizontal grid distance from the start point to the end point of the reference line.
<Grade:>	User input	Available for <Method: Pt/Brg/Dst/Grade>. The gradient of the line from the start point to the end point of the reference line.

Field	Option	Description
<ΔHeight:>	User input	Available for <Method: Pt/Brg/Dst/ΔHt>. The difference in height from the start point to the end point of the reference line.
<Radius:>	User input	Available for <Method: 2 Points/Radius>. The radius of the reference arc.
<Arc Dist:>	Output	The horizontal grid distance along the arc between <Start Point:> and <End Point:> of the arc. ----- is displayed if the distance cannot be calculated.

Next step

PAGE (F6) to access **REFLINE Choose Task & Reference Line, Map** page. Refer to paragraph "REFLINE Choose Task & Reference Line, Map page".

REFLINE Choose Task & Refer- ence Line, Map page

The **Map** page provides an interactive display of the data. Refer to "32 MapView Interactive Display Feature" for information on the functionality and softkeys available.

Next step

IF	THEN
<Task: Measure to XX>	CONT (F1) accepts the changes and accesses REFLINE Measure Points . Refer to "41.5 Measuring to a Reference Line/Arc".
<Task: Stake to XX>	CONT (F1) accepts the changes and accesses REFLINE Enter Offset Values . Refer to "41.6 Staking to a Reference Line/Arc".

IF	THEN
<Task: Gridstake XX>	CONT (F1) accepts the changes and accesses REFLINE Define Grid . Refer to "41.7 Gridstaking to a Reference Line/Arc".

41.4.3

Selecting a Reference Line/Arc from the Job

Description

New reference lines/arcs can be created, existing reference lines/arcs can be edited and previously entered reference lines/arcs can be selected from the **<Control Job:>**.

Access step-by-step

Step	Description
1.	Refer to "41.2 Accessing Reference Line" to access REFLINE Reference Line/Arc Begin .
2.	CONT (F1) to access REFLINE Choose Task & Reference Line, Reference page .
3.	REFLINE Choose Task & Reference Line, Reference page Select <Ref to Use: Select from Job> .

REFLINE Choose Task & Refer- ence Line, Reference page

This screen contains the **Reference** page and the **Map** page. The explanations for the softkeys and the fields are as for manually entering a reference line. The **<Method:>** field is not available and all line definition fields are outputs, all other differences are described below.

The fields shown depend on the options chosen for **<Task:>** and **<Method:>** in **REFLINE New Reference XX**. Refer to paragraph "Create reference line/arc step-by-step".

Description of fields

Field	Option	Description
<Ref Line:>	Choicelist	Available for <Task: XX Line> . The reference line to be used. Accesses REFLINE Manage Reference Lines .

Field	Option	Description
<Ref Arc:>	Choicelist	Available for <Task: XX Arc>. The reference arc to be used. Accesses REFLINE Manage Reference Arcs .

Next step

PAGE (F6) to access **REFLINE Choose Task & Reference Line, Map** page. Refer to paragraph "REFLINE Choose Task & Reference Line, Map page".

**REFLINE
Choose Task & Refer-
ence Line,
Map page**

The **Map** page provides an interactive display of the data. The reference line/arc can be viewed but not defined using this page. Refer to "32 MapView Interactive Display Feature" for information on the functionality and softkeys available.

Next step

IF	THEN
the desired reference line/arc needs to be created, edited or selected	highlight <Ref Line:> or <Ref Arc:> and press ENTER to access REFLINE Manage Reference XX . Refer to paragraph "REFLINE Manage Reference XX".
the desired reference line/arc has been selected	<ul style="list-style-type: none"> for <Task: Measure to XX> CONT (F1) to access REFLINE Measure Points, Ref XX page. Refer to "41.5 Measuring to a Reference Line/Arc". for <Task: Stake to XX> CONT (F1) to access REFLINE Enter Offset Values. Refer to "41.6 Staking to a Reference Line/Arc".

IF	THEN
	<ul style="list-style-type: none"> for <Task: Gridstake XX> CONT (F1) to access REFLINE Define Grid. Refer to "41.7 Grid-staking to a Reference Line/Arc".
offsets are to be defined	OFFSET (F4) to access REFLINE Define Offsets .

REFLINE Manage Reference XX

The screen name will be either **REFLINE Manage Reference Lines** for <Task: **XX Line**> or **REFLINE Manage Reference Arcs** for <Task: **XX Arc**>. Apart from the screen name the appearance of the screen and the functionality of the softkeys is the same.

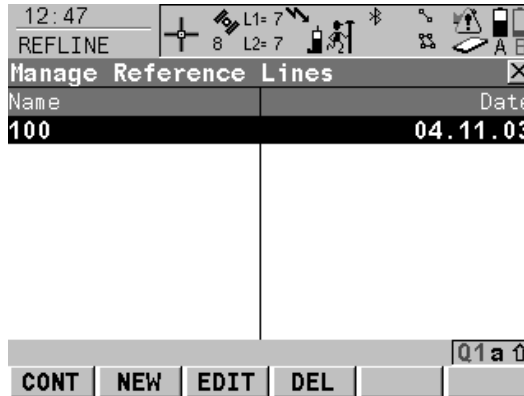

CONT (F1)

To select the highlighted reference line/arc and to return to the screen from where this screen was accessed.

NEW (F2)

To create a reference line/arc. Refer to paragraph "Create reference line/arc step-by-step".

EDIT (F3)

To edit a reference line/arc. Refer to paragraph "Edit reference line/arc step-by-step".

DEL (F4)

To delete a reference line/arc.

Description of columns

Column	Description
Name	Names of all the reference lines/arcs available in the < Control Job >.
Date	Date that the reference line/arc was created.

Next step



IF a reference line/arc	THEN
is to be selected	highlight the desired reference line/arc. CONT (F1) closes the screen and returns to REFLINE Choose Task & Reference Line .
is to be created	NEW (F2) . Refer to paragraph "Create reference line/arc step-by-step".
is to be edited	highlight the reference line/arc and EDIT (F3) . Refer to paragraph "Edit reference line/arc step-by-step".

Create reference line/arc step-by-step

The following table explains the most common settings. Refer to the stated chapter for more information on screens.

Step	Description	Refer to chapter
1.	Refer to "41.2 Accessing Reference Line" to access REFLINE Reference Line/Arc Begin .	

Step	Description	Refer to chapter
2.	CONT (F1) to access REFLINE Choose Task & Reference Line, Reference page.	
3.	REFLINE Choose Task & Reference Line, Reference page Select <Ref to Use: Select from Job> .	
4.	Highlight <Ref Line:> or <Ref Arc:> and press ENTER to access REFLINE Manage Reference XX .	
5.	NEW (F2) to access REFLINE New Reference XX, Input page.	
6.	<p>REFLINE New Reference XX, Input page</p> <p><Ref ID:> The ID of the new reference line/arc.</p> <p>The other fields available depend on the option chosen for <Task:> in REFLINE Choose Task & Reference Line, Reference page and <Method:> on this screen.</p> <ul style="list-style-type: none"> • For <Task: XX Line> <p><Method:> The method by which the reference line will be defined. <Method: 2 Points> uses two known points to define the reference line. <Method: Pt/Brg/Dst/Grade> defines the reference line using a known point, a distance, a bearing and the gradient of the line. <Method: Pt/Brg/Dst/ΔHt> is the same as above but uses the difference in height instead of the gradient.</p> <p><Line Length:> Available for <Method: 2 Points>. The horizontal grid distance between <Start Point:> and <End Point:> of the line. ----- is displayed if the distance cannot be calculated.</p> 	41.4.2

Step	Description	Refer to chapter
	<ul style="list-style-type: none"> For <Task: XX Arc> <Method:> The method by which the reference arc will be defined. <Method: 3 Points> defines the reference arc using three known points. <Method: 2 Points/Radius> defines the reference arc with two known points and a known radius. <Arc Dist:> The horizontal grid distance along the arc between <Start Point:> and <End Point:> of the arc. ----- is displayed if the distance cannot be calculated. Choose the method by which to define a reference line/arc and enter the appropriate parameters. 	
	SURVY (F5) available for <Start Point:> , <Second Point> and <End Point:> . To manually occupy a point.	
	For all point fields, the MapView interactive display on the Map page can be used to select the desired point.	32
7.	PAGE (F6) to access REFLINE New Reference XX, Map page.	
8.	REFLINE New Reference XX, Map page MapView displays the reference line/arc as a solid line.	32.5
9.	STORE (F1) to store changes and return to REFLINE Manage Reference XX .	

Edit reference line/arc step-by-step

Step	Description
1.	Refer to "41.4.3 Selecting a Reference Line/Arc from the Job" to access REFLINE Manage Reference XX .
2.	EDIT (F3) to access REFLINE Edit Reference XX, Input page.
3.	<p>All the following steps are identical with the creation of a new reference line/arc except for the following differences.</p> <ul style="list-style-type: none">• All fields except <Ref ID:> are output fields.• SURVY (F5) is not available.• A Plot page replaces the Map page. Refer to "32 MapView Interactive Display Feature" for information on the functionality and softkeys available. <p>Refer to paragraph "Create reference line/arc step-by-step". Follow the instructions from step 6. onwards.</p>

41.4.4

Defining Reference Line/Arc Offsets

Description

A reference line can be offset, shifted and rotated, a reference arc can be offset.

Diagram

Reference line offsets

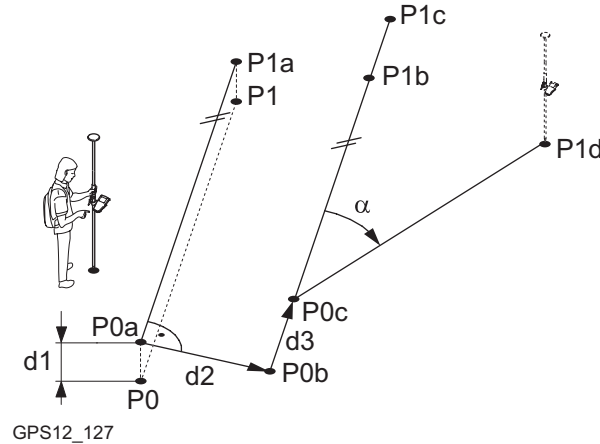

- P0 Start point
- P1 End point
- P0a Start point with **<Height Offset:>**
- P1a End point with **<Height Offset:>**
- P0b Start point with **<Offset Line:>**
- P1b End point with **<Offset Line:>**
- P0c Start point with **<Shift Line:>**
- P1c End point with **<Shift Line:>**
- P1d End point with **<Rotation Line:>**
- d1 **<Height Offset:>**
- d2 **<Offset Line:>**
- d3 **<Shift Line:>**
- α **<Rotation Line:>**

Reference arc offsets

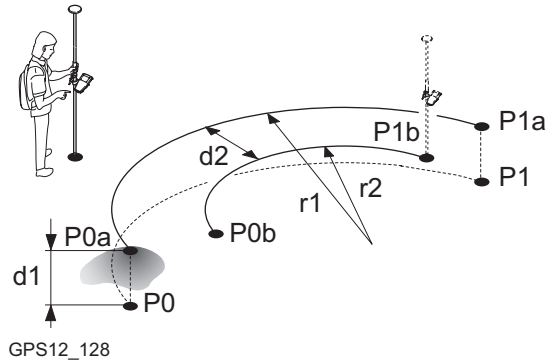

- P0 Start point
- P1 End point
- P0a Start point with **<Height Offset:>**
- P1a End point with **<Height Offset:>**
- P0b Start point with **<Offset Arc:>**
- P1b End point with **<Offset Arc:>**
- d1 **<Height Offset:>**
- d2 **<Offset Arc:>**
- r1 Radius before offset
- r2 Radius after offset

Access step-by-step

Step	Description
1.	Refer to "41.2 Accessing Reference Line" to access REFLINE Reference Line/Arc Begin .
2.	CONT (F1) to access REFLINE Choose Task & Reference Line .
3.	OFFSET (F4) to access REFLINE Define Offsets .

REFLINE Define Offsets

This screen contains different fields depending on the options chosen for **<Heights:>** in **REFLINE Configuration, Heights** page, and **<Task:>** in **REFLINE Choose Task & Reference Line, Reference** page.

**CONT (F1)**

To confirm the selections and to return to the previous screen.

SHIFT CONF (F2)

To configure the reference line/arc. Refer to "41.3 Configuring Reference Line".

**Description of fields**

Field	Option	Description
<Offset Line:> or <Offset Arc:>	User input	Distance to horizontally offset reference line/arc to the left or right.  When an offset is applied to an arc the radius of the arc changes.
<Shift Line:>	User input	Available for <Task: XX Line> unless <Heights: Use Ref Line> in REFLINE Configuration, Heights page. Distance to horizontally shift reference line forward or back.

Field	Option	Description
<Height Offset:>	User input	Available for <Heights: Use Start Point> and <Heights: Use Ref Line>. The vertical offset of the reference line/arc.
<DTM Offset:>	User input	Available for <Heights: Use DTM Model>. The vertical offset of the DTM model.
<Rotate Line:>	User input	Available for <Task: XX Line> unless <Heights: Use Ref Line> in REFLINE Configuration, Heights page. Angle by which to rotate the reference line.

Next step

CONT (F1) closes the screen and returns to **REFLINE Choose Task & Reference Line**.

41.4.5

Defining Reference Line/Arc Slopes

Description

It is possible to measure points and stake points on slopes related to a reference line/arc. A slope can be defined and cut/fill values can then be displayed to the slope when measuring along the reference line/arc. The slope is a plane from the reference line/arc and extends along the length of the reference line/arc.

Slopes can be used when measuring to a reference line/arc, staking a point relative to a reference line/arc or performing a grid stakeout relative to a reference line/arc.

Access step-by-step

Step	Description
1.	Refer to "41.2 Accessing Reference Line" to access REFLINE Reference Line/Arc Begin .
2.	CONT (F1) to access REFLINE Choose Task & Reference Line .
3.	SLOPE (F3) to access REFLINE Define Slope .

REFLINE Define Slope

This screen contains different fields depending on the options chosen for <Heights:> in **REFLINE Configuration**, **Heights** page, and <Task:> in **REFLINE Choose Task & Reference Line**, **Reference** page.

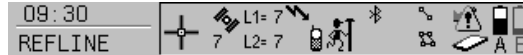

Define Slope

Use Slope : **Yes**

Slope Type : **Left Down**

Slope Grade : **1:1 hv**

Hinge Hz Ofst : **2.000 m**

Hinge V Ofst : **5.000 m**



CONT (F1)

To confirm the selections and to return to the previous screen.

SHIFT CONF (F2)

To configure the reference line/arc. Refer to "41.3 Configuring Reference Line".

Description of fields

Field	Option	Description
<Use Slope:>	Yes or No	<Use Slope:Yes> to define a slope.
<Slope Type:>	Choicelist	The method how the slope will be created.
	Left down	Creates a downward plane extending to the left of the defined reference line/arc.
	Right down	Creates a downward plane extending to the right of the defined reference line/arc.
	Left up	Creates a upward plane extending to the left of the defined reference line/arc.

Field	Option	Description
	Right up	Creates a upward plane extending to the right of the defined reference line/arc.
<Slope Grade:>	User input	Inclination of the slope.
<Hinge Hz Ofst:>	User input	Horizontal offset from the line/arc that sets where the slope starts.
<Hinge V Ofst:>	User input	Vertical offset from the line/arc that sets where the slope starts.

Next step

CONT (F1) closes the screen and returns to **REFLINE Choose Task & Reference Line.**

41.5

41.5.1

Measuring to a Reference Line/Arc

Measure Points

Description

The horizontal and vertical position and the chainage of a manually occupied point can be calculated relative to the defined reference line/arc.

Access

Select **<Task: Measure to XX>** in **REFLINE Choose Task & Reference Line, Reference** page and press **CONT (F1)** to access **REFLINE Measure Points**. Refer to "41.4.4 Defining Reference Line/Arc Offsets" to access **REFLINE Choose Task & Reference Line**.

OR

Press **SURVY (F5)** in **REFLINE XX Stakeout** to access **REFLINE Measure Points**. Refer to "41.6 Staking to a Reference Line/Arc" to access **REFLINE XX Stakeout**.

Measure to line - horizontal measurements

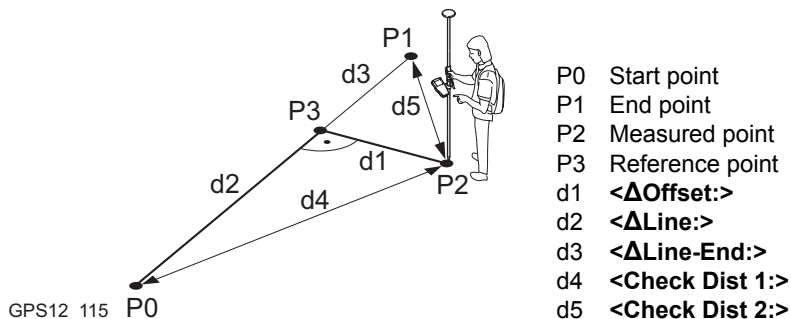

Measure to line - vertical measurements

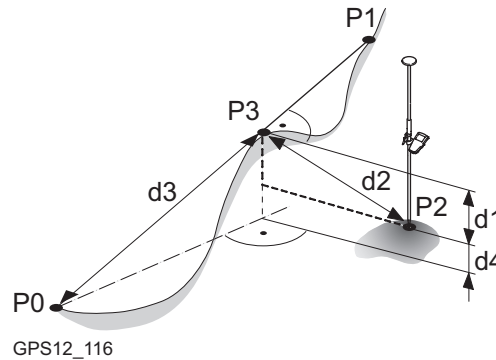

- P0 Start point
- P1 End point
- P2 Measured point
- P3 Reference point
- d1 $\Delta\text{Ht-Line}$:>
- d2 $\Delta\text{Perp Dist}$:>
- d3 $\Delta\text{Spat Dist}$:>
- d4 $\Delta\text{Ht-Start}$:>

Measure to arc - horizontal measurements

Target point inside arc

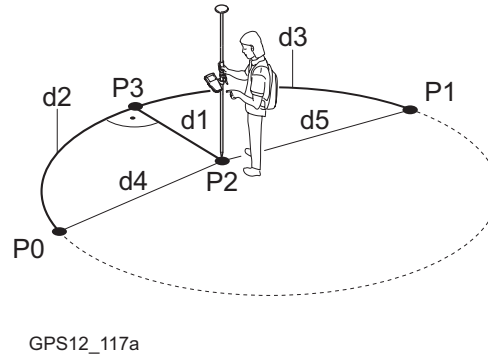

- P0 Start point
- P1 End point
- P2 Measured point
- P3 Reference point
- d1 ΔOffset:>
- d2 ΔArc:>
- d3 $\Delta\text{Arc-End}$:>
- d4 Check Dist 1:>
- d5 Check Dist 2:>

Target point outside arc

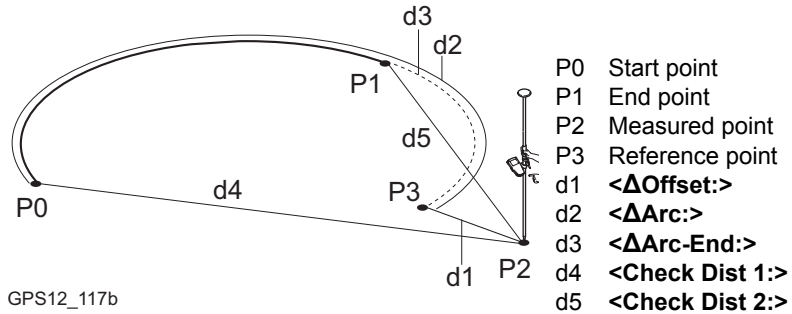

GPS12_117b

Measure to arc - vertical measurements

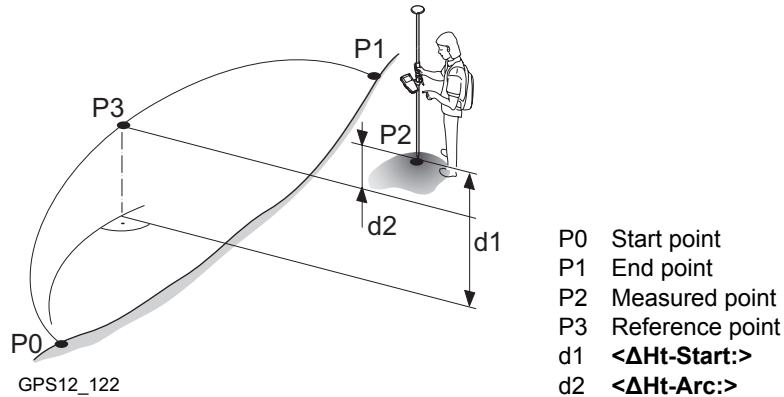

GPS12_122

REFLINE Measure Points, Ref XX page

The pages shown are those from a typical configuration set. An additional page is available when a user defined display mask is used.

09:33		REFLINE		L1= 7		L2= 7		A B	
Measure Points									
Ref Line		Slope		Map					
Point ID	:	143							
Antenna Ht	:	2.000		m					
ΔOffset	:	-106.034		m					
ΔLine	:	145.664		m					
ΔHt-Design	:	-17.057		m					
Design Ht	:	1655.320		m					
ΔLine-End	:	-57.547		m					
						a ↑			
OCUPY				LINE		STAKE		PAGE	

OCUPY (F1)

To start measuring the point. The position mode icon changes to the static icon. (F1) changes to **STOP**. The difference between the current position and the point being staked is still displayed.

STOP (F1)

To end measuring the point. When <Auto STOP: Yes> in **CONFIGURE Point Occupation Settings**, recording of positions ends automatically as defined by the stop criteria. The position mode icon changes to the moving icon. (F1) changes to **STORE**.

STORE (F1)

To store the measured point. When <Auto STORE: Yes> in **CONFIGURE Point Occupation Settings**, the measured point is stored automatically. (F1) changes to **OCUPY**.

LINE (F4)

To define/select a reference line/arc. Accesses **REFLINE Choose Task & Reference Line, Reference page**.

STAKE (F5)

To define reference line offsets to be staked out in relation to the reference line. Accesses **REFLINE Enter Offset Values**. Refer to "41.6 Staking to a Reference Line/Arc".

SHIFT CONF (F2)

To configure the reference line/arc. Available for **OCUPY (F1)** being displayed. Refer to "41.3 Configuring Reference Line".

SHIFT CONEC (F3) and SHIFT DISCO (F3)

To dial the number of the reference station configured in the active configuration set and to hang up immediately after the survey is completed. Available for **OCUPY (F1)** or **STORE (F1)** being displayed and for real-time devices of type digital cellular phone or modem. Available for **<Auto CONEC: No>** in **CONFIGURE GSM Connection**.

SHIFT INIT (F4)

To select an initialisation method and to force a new initialisation. Available for **OCUPY (F1)** or **STORE (F1)** being displayed and for configuration sets allowing phase fixed solutions.

Refer to "44.6.2 Accessing Initialisation for Real-Time Rover Operations".

SHIFT INDIV (F5) and SHIFT RUN (F5)

To change between entering an individual point ID different to the defined ID template and the running point ID according to the ID template. Refer to "19.1 ID Templates".

SHIFT QUIT (F6)

To exit Reference Line application program.

The fields available depend on the options chosen for **<Heights:>** and **<Edit Height:>** in **REFLINE Configuration, Heights** page and **<Task:>** in **REFLINE Choose Task & Reference Line, Reference** page. The following fields are always available:

Description of fields

Field	Option	Description
<Point ID:>	User input	The point ID of the point to be measured.
<Antenna Ht:>	User input	The height of the antenna that is being used. Changing the antenna height here does not update the default antenna height as defined in the active configuration set. The changed antenna height is used until the application program is exited.
<ΔOffset:>	Output	Perpendicular offset from the reference line/arc measured from the reference point to the measured point. For reference arcs, <ΔOffset:> , <ΔArc:> and <ΔArc-End:> values are always calculated so as to produce the smallest <ΔOffset:> possible. To ensure this the arc will be extended if necessary. Refer to paragraph "Measure to arc - horizontal measurements".
<Chainage>	Output	Chainage of the current position along the line/arc. This is the chainage of the start of the reference line/arc plus <ΔLine:>/<ΔArc:> .

Field	Option	Description
<Check Dist 1:>	Output	Horizontal distance from start point to measured point.
<Check Dist 2:>	Output	Horizontal distance from end point to measured point.

For <Task: Measure to Line>

Description of fields

Field	Option	Description
< Δ Line:>	Output	Horizontal distance along the reference line from the start point to the reference point.
< Δ Line-End:>	Output	Horizontal distance along the reference line from the end point to the reference point.

For <Task: Measure to Arc>

Description of fields

Field	Option	Description
< Δ Arc:>	Output	Horizontal distance along the reference arc from the start point to the reference point.
< Δ Arc-End:>	Output	Horizontal distance along the reference arc from the reference point to the end point.

For <Task: Measure to XX>, <Heights: Use Start Point> and <Edit Height: No>

Description of fields

Field	Option	Description
< Δ Ht-Start:>	Output	Height difference between the start point and the measured point.
<Height:>	Output	Height of measured point.

For <Task: Measure to Line>, <Heights: Use Ref Line> and <Edit Height: No>

Description of fields

Field	Option	Description
< Δ Ht-Line:>	Output	Height difference between the reference point on the line and the measured point.
<Height:>	Output	Height of measured point.
< Δ Perp Dist:>	Output	Slope distance between the reference point and the measured point, perpendicular to the reference line.
< Δ Spatial Dist:>	Output	Slope distance between the start point and the reference point.

**For <Task: Measure to Arc>, <Heights: Use Ref Line> and <Edit Height: No>
Description of fields**

Field	Option	Description
<ΔHt-Arc:>	Output	Height difference between the reference point on the arc and the measured point.
<Height:>	Output	Height of measured point.

**For <Task: Measure to XX>, <Heights: Use DTM Model> and <Edit Height: No>
Description of fields**

Field	Option	Description
<ΔHt-DTM:>	Output	Height difference between the measured point and the DTM.
<Height:>	Output	Height of measured point.

**For <Task: Measure to XX>, <Heights: XX> and <Edit Height: Yes>
Description of fields**

Field	Option	Description
<Design Ht:>	User input	Allows input of the design height of the target point. The suggested value for the <Design Ht:> is as configured in the <Heights:> field in REFLINE Configuration, Heights page.

Field	Option	Description
< Δ Ht-Design:>	Output	Height difference between the <Design Ht:> and the height of the measured point.

Next step

PAGE (F6) changes to the **Map** page. Refer to paragraph "REFLINE Measure Reference, Map page".

**REFLINE
Measure Reference,
Map page**

The **Map** page provides an interactive display of the data. Displayed is also

- the horizontal distance or chainage along the reference line/arc from the start point to the reference point.
- the perpendicular offset from the reference line/arc measured from the reference point to the measured point.

Refer to "32 MapView Interactive Display Feature" for information on the functionality and softkeys available.

Next step

PAGE (F6) changes to the first page on this screen.

41.5.2

Working Example

Description

Application: The positions of stakes, indicating the corners of a house that is to be built, need to be measured relative to the title boundary of the property that the house is to be built on. This is done to check that the house is not being built too close to the title boundary in keeping with council regulations.

Reference line/arc: The title boundary is used to define a reference line.

Working technique: Real-time kinematic.

Diagram

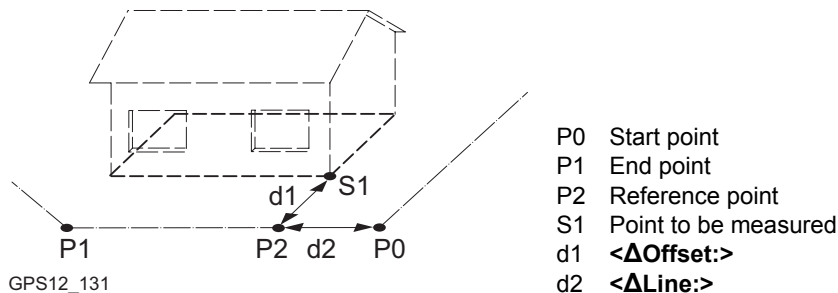





Requirements

- The reference line does not need to be stored.
- **<Write Logfile: Yes>** in **REFLINE Configuration, Logfile** page.
- A real-time reference is running.
- For the rover: **<R-Time Mode: Rover>** in **CONFIGURE Real-Time Mode**.

Field procedure step-by-step

The following table explains the most common settings. Refer to the stated chapter for more information on screens.

Step	Description	Refer to chapter
1.	Refer to "41.2 Accessing Reference Line" to access REFLINE Reference Line/Arc Begin .	
2.	REFLINE Reference Line/Arc Begin Select a job and a configuration set with the settings mentioned above.	41.2
3.	CONT (F1)	
4.	REFLINE Choose Task & Reference Line, Reference page <Task: Measure to Line> <Ref to Use: Manually Enter> <Method: 2 Points>	41.4.2
5.	Highlight <Start Point:> .	
6.	SURVY (F5) to manually occupy P1.	
7.	Highlight <End Point:> .	
8.	SURVY (F5) to manually occupy P2.	
	The Map page provides an interactive display of the defined reference line.	32
9.	CONT (F1)	
10.	Walk to the first point to be measured.	

Step	Description	Refer to chapter
11.	REFLINE Measure Points <Point ID: S1>	41.5
12.	OCUPY (F1) starts collecting data.	
13.	If required, check information, for example on the satellites, the memory or the battery.	
14.	When < Auto STOP: No > in CONFIGURE Point Occupation Settings, STOP (F1) when enough data is collected. At least one epoch of data must be recorded.	19.6.1
15.	When < Auto STORE: No > in CONFIGURE Point Occupation Settings, STORE (F1) to store the point information.	19.6.1
	The results are displayed on the screen. The values in the fields indicate the position of the point being occupied relative to the reference line.	
	It may happen that a point with the same point ID exists in the job. If the codes and/or attribute values of the new and the existing point do not match, a screen opens where they can be corrected.	
	Do not turn off the receiver.	

Step	Description	Refer to chapter
16.	PAGE (F6) to access the Map page which provides an interactive display of the defined reference line and the points measured relative to it. Displayed is also <ul style="list-style-type: none">• the horizontal distance or chainage along the reference line/arc from the start point to the reference point.• the perpendicular offset from the reference line/arc measured from the reference point to the measured point.	32
17.	Are more points to be measured? <ul style="list-style-type: none">• If yes, continue with step 18.• If no, continue with step 20.	
18.	Walk to the next point	
19.	Repeat steps 11. to 17.	
20.	SHIFT QUIT (F6) returns to GPS1200 Main Menu .	
	The results are written to the logfile.	

41.6

41.6.1

Staking to a Reference Line/Arc

Stakeout Points

Description

Allows for the position of a point to be defined relative to a reference line/arc and then staked.

Access

Select **<Task: Stake to XX>** in **REFLINE Choose Task & Reference Line, Reference** page and press **CONT (F1)** to access **REFLINE Enter Offset Values**. Refer to "41.4 Managing Reference Lines/Arcs" to access **REFLINE Choose Task & Reference Line**.

OR

Press **STAKE (F5)** in **REFLINE Measure Points**. Refer to "41.5 Measuring to a Reference Line/Arc" to access **REFLINE Measure Points**.

Stake to line - horizontal measurements

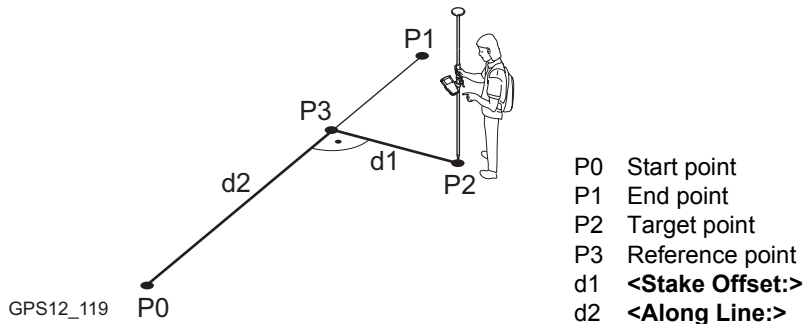

Stake to line - vertical measurements

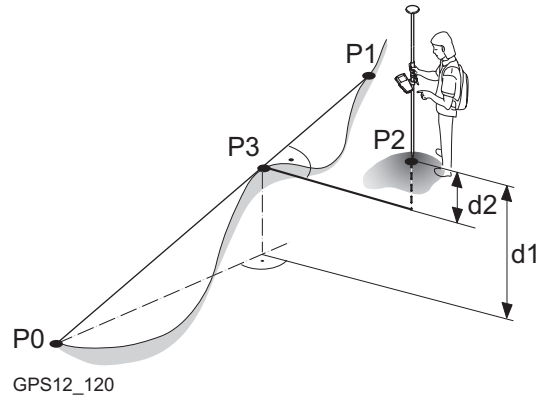

- P0 Start point
- P1 End point
- P2 Target point
- P3 Reference point
- d1 **<Height Offset:>**, for **<Heights: Use Start Point>**
- d2 **<Height Offset:>**, for **<Heights: Use Ref Line>**

Stake to arc - horizontal measurements

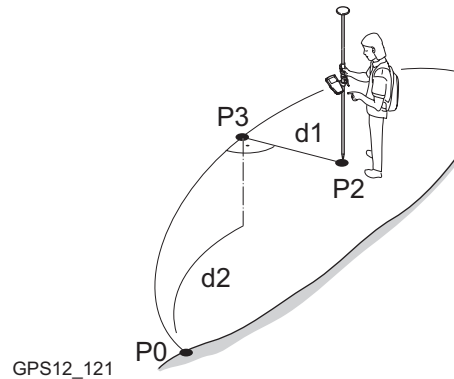

- P0 Start point
- P1 End point
- P2 Target point
- P3 Reference point
- d1 **<Stake Offset:>**
- d2 **<Along Arc:>**

Stake to arc - vertical measurements

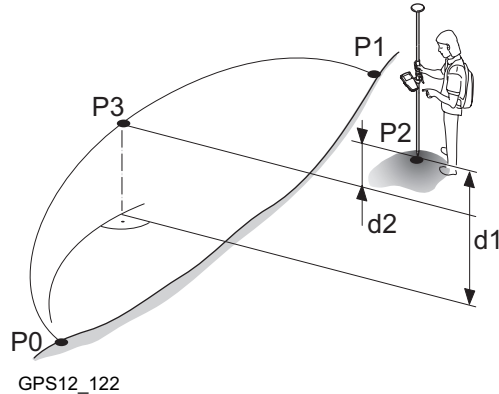

- P0 Start point
- P1 End point
- P2 Target point
- P3 Reference point
- d1 **<Height Offset:>**, for **<Heights: Use Start Point>**

REFLINE Enter Offset Values

This screen is for typing in the stakeout values for a point relative to the reference line/arc. The screen contains different fields depending on the options chosen for **<Heights:>** and **<Edit Height:>** in **REFLINE Configuration, Heights** page and **<Task:>** in **REFLINE Choose Task & Reference Line, Reference** page. The explanations for the softkeys given below are valid in all cases.

13:05
REFLINE
Enter Offset Values
Point ID : 101
Stake Offset : 102.2310 m
Along Line : 102.9231 m
Height Offset: 2.0000 m

CONT LINE SURVY Q1 a ↑

CONT (F1)

To confirm the selections and to continue with the subsequent screen.

LINE (F4)

To define/select a reference line/arc.

Accesses **REFLINE Choose Task & Reference Line**. Refer to "41.4 Managing Reference Lines/Arcs".

SURVY (F5)

To measure a point relative to the reference line/arc.

SHIFT CONF (F2)

To configure the reference line/arc. Refer to "41.3 Configuring Reference Line".

SHIFT INDIV (F5) and SHIFT RUN (F5)

To change between entering an individual point ID different to the defined ID template and the running point ID according to the ID template. Refer to "19.1 ID Templates".

Description of fields

Field	Option	Description
<Point ID:>	User input	The point ID of the target point to be staked.
<Stake Offset:>	User input	The offset from the reference point to the target point.

Field	Option	Description
<Along Line:>	User input	Available for <Task: Stake to Line>. Horizontal distance from the start point to the reference point along the reference line.
<Along Arc:>	User input	Available for <Task: Stake to Arc>. Horizontal distance from the start point to the reference point along the reference arc.
<Chainage:>	User input	Chainage along the line/arc. This is the chainage of the start of the reference line/arc plus <Along Line:>/<Along Arc:>.
<Height Offset:>	User input	Available for <Edit Height: No> unless <Heights: Use DTM Model> in REFLINE Configuration. The height offset of the target point. <ul style="list-style-type: none"> • For <Heights: Use Start Point> The height of the target point is calculated as the height of the start point plus <Height Offset:>. • For <Heights: Use Ref Line> The height of the target point is calculated as the height of the reference point plus <Height Offset:>.
<Design Ht:>	User input	Available for <Edit Height: Yes> in REFLINE Configuration, Heights page. The design height of the target point.

Field	Option	Description
		<ul style="list-style-type: none">• For <Heights: Use Start Point> The suggested height is the height of the start point.• For <Heights: Use Ref Line> The suggested height is the height of the reference point.

Next step

CONT (F1) to accept changes and continue to **REFLINE XX Stakeout**.

**REFLINE
XX Stakeout,
Ref XX page**

The pages shown are those from a typical configuration set. An additional page is available when a user defined display mask is used.

Refer to "43.4.1 Elements of the Graphical Display in the Stakeout" for an explanation of the appearance of the elements of the graphical display within this screen. The display changes depending on what option is chosen for **<Orientate:>** in **REFLINE Configuration, General** page.

This screen contains different fields depending on the options chosen for **<Stake Mode:>** in **REFLINE Configuration, General** page. The explanations for the fields and softkeys given below are valid as indicated.

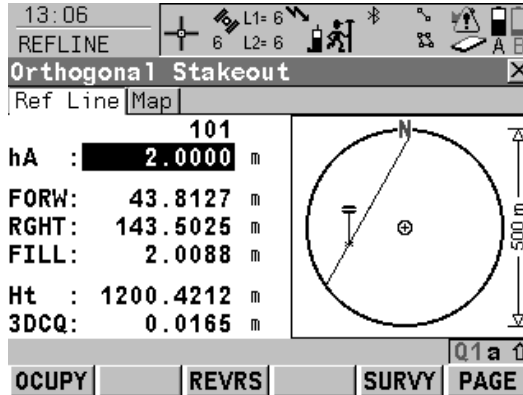

OCUPY (F1)

To start measuring the point being staked. The position mode icon changes to the static icon. (F1) changes to **STOP**. The difference between the current position and the point being staked is still displayed.

STOP (F1)

To end measuring the point being staked. When **<Auto STOP: Yes>** in **CONFIGURE Point Occupation Settings**, recording of positions ends automatically as defined by the stop criteria. The position mode icon changes to the moving icon. (F1) changes to **STORE**.

STORE (F1)

To store the measured point. When **<Auto STORE: Yes>** in **CONFIGURE Point Occupation Settings**, the measured point is stored automatically. (F1) changes to **OCUPY**.

REVRS (F3)

To reverse the graphical display top to bottom. A reversed graphical display can be used when the point to be staked lies behind the current position.

SURVY (F5)

To measure a point relative to the reference line/arc.

PAGE (F6)

To change to another page on this screen.

SHIFT CONF (F2)

To configure the reference line/arc. Available for **OCUPY (F1)** being displayed. Refer to "41.3 Configuring Reference Line".

SHIFT CONEC (F3) and SHIFT DISCO (F3)

To dial the number of the reference station configured in the active configuration set and to hang up immediately after the survey is completed. Available for **OCUPY (F1)** or **STORE (F1)** being displayed and for real-time devices of type digital cellular phone or modem. Available for **<Auto CONEC: No>** in **CONFIGURE GSM Connection**.

SHIFT INIT (F4)

To select an initialisation method and to force a new initialisation. Available for **OCUPY (F1)** or **STORE (F1)** being displayed and for configuration sets allowing phase fixed solutions. Refer to "44.6.2 Accessing Initialisation for Real-Time Rover Operations".

SHIFT INDIV (F5) and SHIFT RUN (F5)

To change between entering an individual point ID different to the defined ID template and the running point ID according to the ID template. Refer to "19.1 ID Templates".

SHIFT QUIT (F6)

To exit Reference Line application program.

Description of fields

Field	Option	Description
First field on the screen	Choicelist	The point ID of the point to be staked.
<hA:>	User input	The default antenna height as defined in the active configuration set is suggested. Refer to "2.3 Determining Antenna Heights". Changing the antenna height here does not update the default antenna height as defined in the active configuration set. The changed antenna height is used until the application program is exited.
<CUT:>	Output	The negative height difference from the height of the current position to the height of the point to be staked. To move down.
<FILL:>	Output	The positive height difference from the height of the current position to the height of the point to be staked. To move up.
<Ht:>	Output	Available for <Edit Height: No> in REFLINE Configuration, Heights page. The orthometric height of the current position is displayed. If the orthometric height cannot be displayed, the local ellipsoidal height is displayed. If it is not possible to display the local ellipsoidal height, the WGS 1984 height is displayed.

Field	Option	Description
<D Ht:>	User input	Available for <Edit Height: Yes> in REFLINE Configuration, Heights page. The design height, which is the orthometric height of the point to be staked, is displayed. If the orthometric height cannot be displayed, the local ellipsoidal height is displayed. If it is not possible to display the local ellipsoidal height, the WGS 1984 height is displayed. Changing the value for <D Ht:> changes the values displayed for <CUT:> and <FILL:>.
<3DCQ:>	Output	Available for code and phase fixed solutions. The current 3D coordinate quality of the computed position.
<PDOP:>	Output	Available for autonomous solutions. The current PDOP of the autonomous solution.

For <Stake Mode: Polar>

Description of fields

Field	Option	Description
<DIRC:>	Output	The bearing from the direction of the orientation to the point to be staked seen from the current position.
<DIST:>	Output	Horizontal distance from the current position to the point to be staked.

For <Stake Mode: Orthogonal>

Description of fields

Field	Option	Description
<FORW:>	Output	The horizontal distance from the current position to the point to be staked in the direction of the orientation.
<BACK:>	Output	The horizontal distance from the current position to the point to be staked in the reverse direction of the orientation.
<RGHT:>	Output	Horizontal distance from the current position to the point to be staked orthogonal to the right of the orientation direction.
<LEFT:>	Output	Horizontal distance from the current position to the point to be staked orthogonal to the left of the orientation direction.

Next step

PAGE (F6) changes to the **Map** page. Refer to paragraph "REFLINE XX Stakeout, Map page".

REFLINE XX Stakeout, Map page

The **Map** page provides an interactive display of the data. Displayed is also

- the horizontal distance from the current position to the point to be staked.
- the height difference from the height of the current position to the height of the point to be staked.

Refer to "32 MapView Interactive Display Feature" for information on the functionality and softkeys available.

Next step

PAGE (F6) changes to the first page on this screen.

41.6.2

Working Example

Description

Application:	A curb is to be defined using offsets from the centreline of a road that is being built.
Reference line/arc:	The defined centre line of the curve is used as a reference arc.
Working technique:	Real-time kinematic.

Diagram

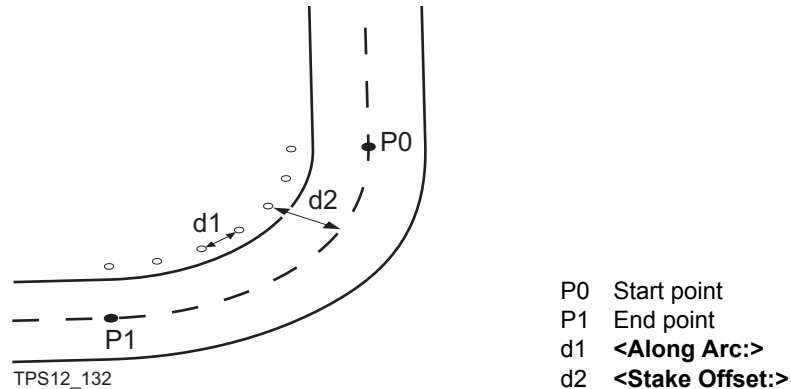



Requirements



- The reference arc is already defined and saved in a job.
- **<Write Logfile: Yes>** in **REFLINE Configuration, Logfile** page.
- A real-time reference is running.
- For the rover: **<R-Time Mode: Rover>** in **CONFIGURE Real-Time Mode**.

Field procedure step-by-step

The following table explains the most common settings. Refer to the stated chapter for more information on screens.

Step	Description	Refer to chapter
1.	Refer to "41.2 Accessing Reference Line" to access REFLINE Reference Line/Arc Begin .	
2.	REFLINE Reference Line/Arc Begin Select a job and a configuration set with the settings mentioned above.	41.2
3.	CONT (F1) .	
4.	REFLINE Choose Task & Reference Line, Reference page <Task: Stake to Arc> <Ref to Use: Select from Job>	41.4.3
5.	Highlight <Ref Arc:> .	
6.	Open the choicelist to access REFLINE Manage Reference Arcs .	
7.	REFLINE Manage Reference Arcs Select the correct reference arc.	41.4
8.	CONT (F1) returns to REFLINE Choose Task & Reference Line, Reference page .	
	The Map page provides an interactive display of the defined reference arc.	32
9.	CONT (F1) .	

Step	Description	Refer to chapter
10.	REFLINE Enter Offset Values <Point ID: CL1> <Stake Offset: 5.2000> <Along Arc: 2.0000> <Height Offset: 0.0000>	41.6
11.	CONT (F1)	
12.	REFLINE XX Stakeout, Ref XX page Depending on the configuration of the staking options in REFLINE Configuration, General page, the graphical display and the values in the fields indicate how to find the point to be staked.	
13.	OCUPY (F1) starts collecting data.	
14.	If required, check information, for example on the satellites, the memory or the battery.	
15.	When < Auto STOP: No > in CONFIGURE Point Occupation Settings, STOP (F1) when enough data is collected. At least one epoch of data must be recorded.	19.6.1
16.	When < Auto STORE: No > in CONFIGURE Point Occupation Settings, STORE (F1) to store the point information.	19.6.1
	The results are displayed on the screen.	

Step	Description	Refer to chapter
	It may happen that a point with the same point ID exists in the job. If the codes and/or attribute values of the new and the existing point do not match, a screen opens where they can be corrected.	
	Do not turn off the receiver.	
17.	<p>PAGE (F6) to access the Map page which provides an interactive display of the defined reference arc and the points staked relative to it. Displayed is also</p> <ul style="list-style-type: none"> • the horizontal distance from the current position to the point to be staked. • the height difference from the height of the current position to the height of the point to be staked. 	32
18.	<p>Are more points to be staked?</p> <ul style="list-style-type: none"> • If yes, continue with step 19. • If no, continue with step 21. 	
19.	<p>REFLINE Enter Offset Values</p> <p>Enter the parameters of the next point to be staked.</p>	41.6
20.	Repeat steps 11. to 18.	
21.	SHIFT QUIT (F6) returns to GPS1200 Main Menu .	
22.	The results are written to the logfile.	

41.7

41.7.1

Gridstaking to a Reference Line/Arc

Gridstaking Points

Description

A grid can be defined relative to a reference line/arc and points staked out in that defined grid.

Access step-by-step

Step	Description
1.	Refer to "41.2 Accessing Reference Line" to access REFLINE Reference Line/Arc Begin .
2.	CONT (F1) to access REFLINE Choose Task & Reference Line .
3.	REFLINE Choose Task & Reference Line, Reference page <Task: Gridstake XX> .
4.	CONT (F1) to access REFLINE Define Grid .

Gridstake line methods Start at Begin

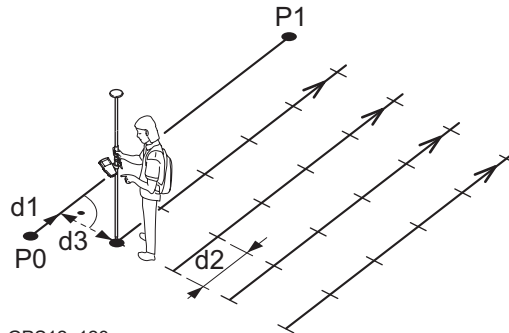

GPS12_123

- P0 Start point
- P1 End point
- d1 <Begin Grid At:>
- d2 <Increment By:>
- d3 <Line Offsets:>

Current Grid Pt

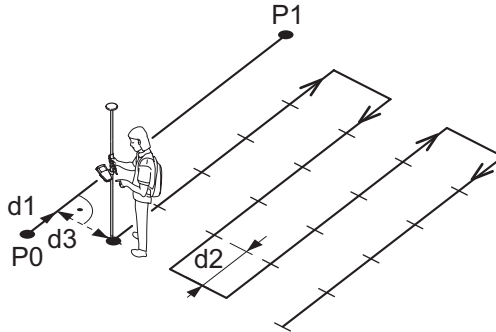

GPS12_124

- P0 Start point
- P1 End point
- d1 <Begin Grid At:>
- d2 <Increment By:>
- d3 <Line Offsets:>

Gridstake arc methods **Start at Begin**

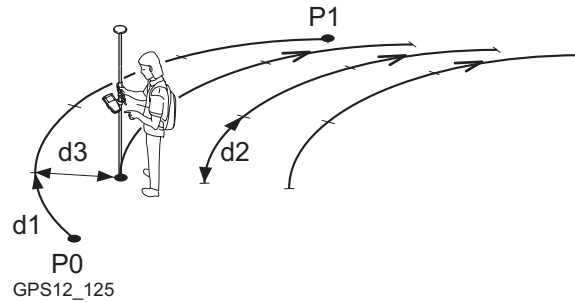

- P0 Start point
- P1 End point
- d1 **<Begin Grid At:>**
- d2 **<Increment By:>**
- d3 **<Line Offsets:>**

Current Grid Pt

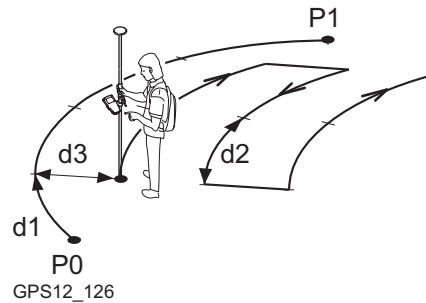

- P0 Start point
- P1 End point
- d1 **<Begin Grid At:>**
- d2 **<Increment By:>**
- d3 **<Line Offsets:>**

REFLINE

Define Grid

13:11
REFLINE
Define Grid

Begin Grid at: 0.0000 m
Increment by : 10.0000 m

Line Offsets : 10.0000 m
Next Line : Current Grid Pt →

Point ID : Grid ID →

CONT LINE Q1 a ↑

CONT (F1)

To confirm the selections and to continue with the subsequent screen.

LINE (F4)

To define/select a reference line/arc. Accesses **REFLINE Choose Task & Reference Line**. Refer to "41.4 Managing Reference Lines/Arcs".

SHIFT CONF (F2)

To configure the reference line/arc. Refer to "41.3 Configuring Reference Line".

Description of fields

Field	Option	Description
<Begin Grid At:>	User input	Distance along the reference line/arc from the start point to the first target point to be staked.
<Chainage:>	User input	Chainage of the first target point to be staked along the line/arc. This is the chainage of the start of the reference line/arc plus <Begin Grid At:>.
<Increment By:>	User input	Spacing between points on the grid line.
<Line Offsets:>	User input	Spacing between grid lines.
<Next Line:>		Method by which the grid will be staked out.

Field	Option	Description
	Start at Begin	Each new grid line is started at the same end as where the previous grid line started.
	Current Grid Pt	Each new grid line is started at the same end as where the previous grid line finished.
<Point ID:>	Grid ID	Determines the format of the point ID for grid points. Point ID is shown as the position of the grid being staked where +yyy.yy is the station position along the grid line and +xxx.xx is the grid line offset.
	Pt ID Template	The point ID template as defined in the active configuration set is used. The point ID template can be defined for <Survey Pts:> in CONFIGURE ID Templates . Refer to "19.1 ID Templates".

Next step

CONT (F1) to accept changes and continue to **REFLINE Stake +yyy.yy +xxx.xx, Ref XX** page.

REFLINE Stake +yyy.yy +xxx.xx, Ref XX page

The title of this screen indicates the position of the grid being staked where +yyy.yy is the station position along the grid line and +xxx.xx is the grid line offset.

The functionality of this screen is very similar to **REFLINE XX Stakeout, Ref XX** page. Differences between the two screens are outlined below. Refer to paragraph "REFLINE XX Stakeout, Ref XX page" for all other key and field explanations.

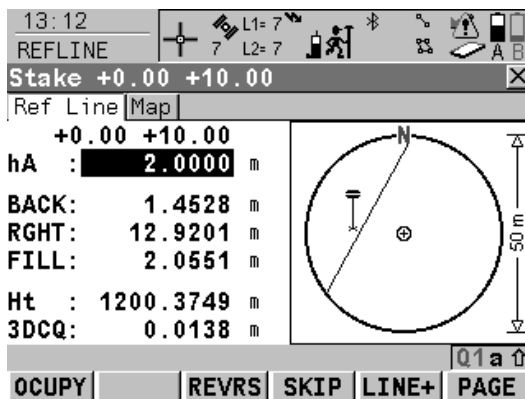
**SKIP (F4)**

To skip the currently displayed station and increment to the next station. Available for **OCUPY (F1)** being displayed.

LINE (F5)

To start staking the next grid line. The position of the first point on the new line is determined by the option selected for **<Next Line:>**. Available for **OCUPY (F1)** being displayed.

Description of fields

Field	Option	Description
First field on the screen	User input	The point ID of the grid point to be staked. The point ID is based on the selection for <Point ID:> in REFLINE Define Grid . If a different point ID is typed in, the next point ID will still be shown as the next automatically computed point ID.
<Ht:>	Output	Available for <Edit Height: No> in REFLINE Configuration, Heights page.

Field	Option	Description
		The orthometric height of the current position is displayed. If the orthometric height cannot be displayed, the local ellipsoidal height is displayed. If it is not possible to display the local ellipsoidal height, the WGS 1984 height is displayed.
<D Ht:>	User input	<p>Available for <Edit Height: Yes> in REFLINE Configuration, Heights page.</p> <p>The design height, which is the orthometric height of the target point to be staked, is displayed. If the orthometric height cannot be displayed, the local ellipsoidal height is displayed. If it is not possible to display the local ellipsoidal height, the WGS 1984 height is displayed.</p> <p>If a design height has been entered and SKIP (F4) or LINE (F5) is used the true grid height for the next point is shown as the suggested height.</p>

Next step

PAGE (F6) changes to the **Map** page. Refer to paragraph "REFLINE Stake +yyy.yy +xxx.xx, Map page".

REFLINE
Stake +yyy.yy +xxx.xx,
Map page

The **Map** page provides an interactive display of the data. Displayed is also

- the horizontal distance from the current position to the point to be staked.
- the height difference from the height of the current position to the height of the point to be staked.

Refer to "32 MapView Interactive Display Feature" for information on the functionality and softkeys available.

Next step

PAGE (F6) changes to the first page on this screen.

41.7.2

Working Example

Description

- Application: The positions of bore-holes need to be staked out in a regular grid over the area of a site to be used for landfill.
- Reference line/arc: Two known points on the site can be used to define the reference line.
- Working technique: Real-time kinematic.

Diagram

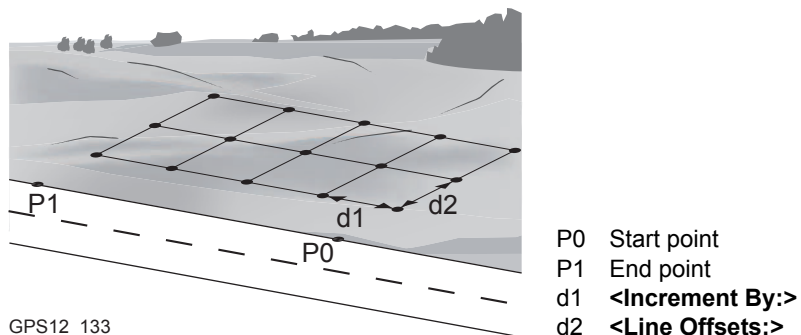



Requirements



- A new reference line needs to be created and saved with the job.
- <Write Logfile: Yes> in **REFLINE Configuration, Logfile** page.
- A real-time reference is running.
- For the rover: <R-Time Mode: Rover> in **CONFIGURE Real-Time Mode**.

Field procedure step-by-step

The following table explains the most common settings. Refer to the stated chapter for more information on screens.

Step	Description	Refer to chapter
1.	Refer to "41.2 Accessing Reference Line" to access REFLINE Reference Line/Arc Begin .	
2.	REFLINE Reference Line/Arc Begin Select a job and a configuration set with the settings mentioned above.	41.2
3.	CONT (F1)	
4.	REFLINE Choose Task & Reference Line, Reference page <Task: Gridstake Line> <Ref to Use: Select from Job>	41.4.3
5.	Highlight <Ref Line:> .	
6.	Open the choicelist to access REFLINE Manage Reference Lines .	
7.	NEW (F2) to access REFLINE New Reference Line, Input page .	
8.	REFLINE New Reference Line, Input page <Ref ID: Line001> <Method: 2 Points> Select the appropriate points from the choicelist.	41.4.3
	The Map page provides an interactive display of the defined reference line.	32

Step	Description	Refer to chapter
9.	STORE (F1)	
10.	CONT (F1) returns to REFLINE Choose Task & Reference Line, Reference page.	
	The Map page provides an interactive display of the defined reference line.	32
11.	CONT (F1)	
12.	REFLINE Define Grid <Begin Grid At: 0> <Increment By: 20.0000> <Line Offsets: 20.0000> <Next Line: Current Grid Pt> <Point ID: Grid ID>	41.7
13.	CONT (F1)	
14.	REFLINE Stake +yyy.yy +xxx.xx, Ref XX page Depending on the configuration of the staking options in REFLINE Configuration, General page, the graphical display and the values in the fields indicate how to find the point to be staked.	41.7
15.	OCUPY (F1) starts collecting data.	
16.	If required, check information, for example on the satellites, the memory or the battery.	

Step	Description	Refer to chapter
17.	When <Auto STOP: No> in CONFIGURE Point Occupation Settings, STOP (F1) when enough data is collected. At least one epoch of data must be recorded.	19.6.1
18.	When <Auto STORE: No> in CONFIGURE Point Occupation Settings, STORE (F1) to store the point information.	19.6.1
	The results are displayed on the screen.	
	It may happen that a point with the same point ID exists in the job. If the codes and/or attribute values of the new and the existing point do not match, a screen opens where they can be corrected.	
19.	PAGE (F6) to access the Map page which provides an interactive display of the defined reference line and the grid points staked relative to it. Displayed is also <ul style="list-style-type: none"> • the horizontal distance from the current position to the point to be staked. • the height difference from the height of the current position to the height of the point to be staked. 	32
20.	Repeat steps 14. to 18. including the advice until all grid points have been staked.	
21.	SHIFT QUIT (F6) returns to GPS1200 Main Menu .	
22.	The results are written to the logfile.	

42

Reference Plane

42.1

Overview

Description

The Reference Plane application program can be used to measure points relative to a reference plane.

Reference plane tasks

The Reference Plane application program can be used for the following tasks:

- Measuring points to calculate and store the perpendicular distance to the plane.
- Viewing and storing the instrument and/or local coordinates of the measured points.
- Viewing and storing the height difference from the measured points to the plane.



Planes can only be computed with grid coordinates.

Activating the application program

The Reference Plane application program must be activated via a licence key. Refer to "30 Tools...\Licence Keys" for information on how to activate the application program.

Properties of measured points

The properties stored with measured points are:

- Class: Either **MEAS** or **NAV** depending on the position status when the point was occupied.
- Sub class: **GPS Fixed**, **GPS Code Only**, **GNSS Fixed** or **GNSS Code Only**
- Source: **Ref Plane (Meas)**
- Instrument source: **GPS**

Defining a reference plane

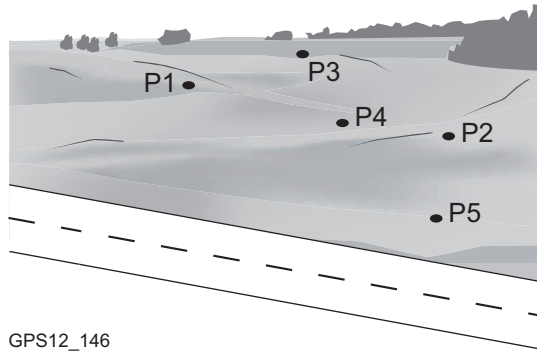

GPS12_146

- P1 Point defining reference plane
- P2 Point defining reference plane
- P3 Point defining reference plane
- P4 Point defining reference plane
- P5 Point defining reference plane

Reference planes are created using a right hand system. For two points defining a plane, a vertical plane is used. A reference plane is defined with the X axis and the Z axis of the plane. The Y axis of the plane defines the positive direction of the plane. A reference plane can be defined in the following ways:

- vertical
- tilted



- For GPS1200 the Reference Plane application program is only applicable for tilted plane definitions.
- For TPS1200, the Reference Plane application program is also applicable for vertical plane definitions.

Tilted plane

Any number of points define the plane. The axis of the tilted reference plane are:

X axis: Horizontal and parallel to the plane

Z axis: Defined by steepest direction of the plane

Y axis: Perpendicular to the plane; increases in the direction as defined



Offsets are applied in the direction of the Y axis.

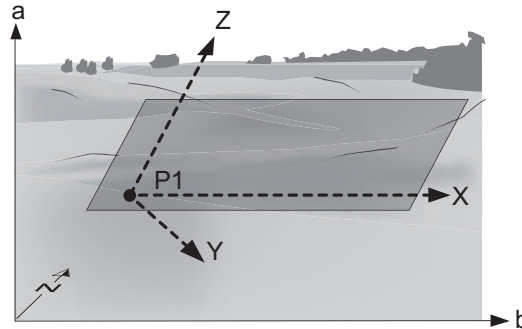

GPS12_147

a Height
b Easting
N Northing
P1 Origin of plane
X X axis of plane
Y Y axis of plane
Z Z axis of plane

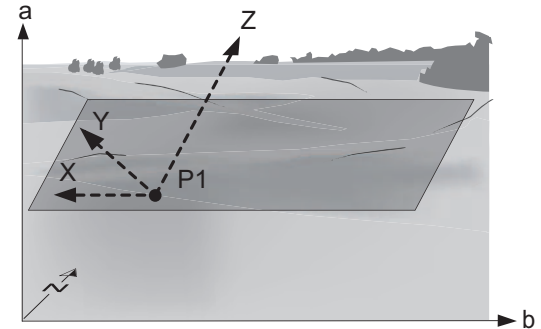

GPS12_148

a Height
b Easting
N Northing
P1 Origin of plane
X X axis of plane
Y Y axis of plane
Z Z axis of plane



With four or more points a least squares adjustment is calculated resulting in a best fit plane.

Origin

The origin of the reference plane can be defined to be in the plane coordinates or in relation to the national coordinate system.

Positive direction of plane

The positive direction of the plane is defined by the direction of the Y axis. The direction can be changed by selecting a point which defines the direction of the Y axis.

Offset of the plane

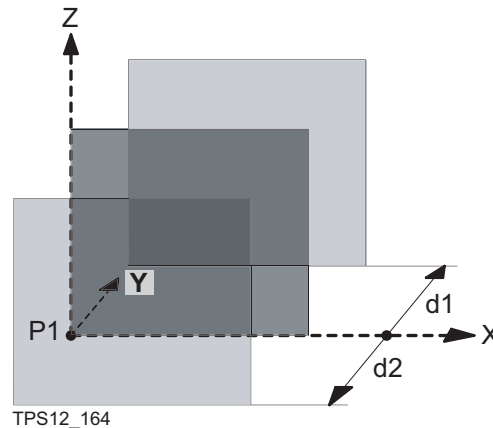

- P1 Origin of plane
- X X axis of plane
- Y Y axis of plane
- Z Z axis of plane
- d1 Positive offset
- d2 Negative offset

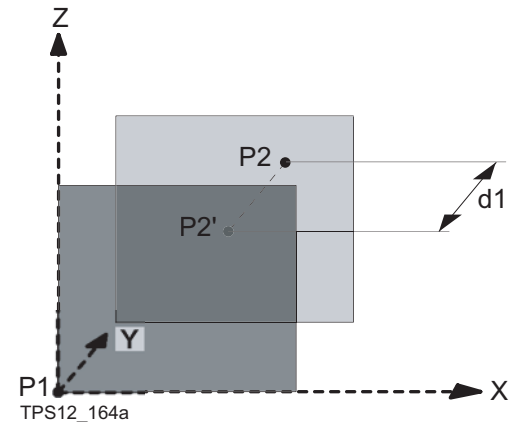

- P1 Origin of plane
- P2 Point defining offset of plane
- P2' P2 projected on original plane
- d1 Offset defined by P2
- X X axis of plane
- Y Y axis of plane
- Z Z axis of plane

42.2

Accessing Reference Plane

Access

Select **Main Menu: Programs...\Reference Plane**.

OR

Press **PROG**. Highlight **Reference Plane**. **CONT (F1)**. Refer to "36.2 Accessing the Application Programs Menu" for information on the **PROG** key.

OR

Press a hot key configured to access the screen **REFPLANE Reference Plane Begin**. Refer to "6.1 Hot Keys" for information on hot keys.

OR

Press **USER**. Refer to "6.2 USER Key" for information on the **USER** key.

REFPLANE

Reference Plane Begin

13:11 REFPLANE Reference Plane Begin

Job : Job1

Coord System : Local

Codelist : Codelist 2

Config Set : RTK Rover

Antenna : AX1202 Pole

CONT CONF CSYS

CONT (F1)

To confirm the selections and to continue with the subsequent screen.

CONF (F2)

To configure the Reference Plane application program. Refer to "42.3 Configuring Reference Plane".

CSYS (F6)

To select a different coordinate system.

Description of fields

Field	Option	Description
<Job:>	Choicelist	The active job. All jobs from Main Menu: Manage...\Jobs can be selected.
<Coord System:>	Output	The coordinate system currently attached to the selected <Job:>.
<Codelist:>	Choicelist	No codes are stored in the selected job. All codelists from Main Menu: Manage...\Codelists can be selected.
	Output	Codes have already been stored in the selected <Job:>. If codes had been copied from a System RAM codelist, then the name of the codelist is displayed. If codes have not been copied from a System RAM codelist but typed in manually, then the name of the active job is displayed.
<Config Set:>	Choicelist	The active configuration set. All configuration sets from Main Menu: Manage...\Configuration Sets can be selected.
<Antenna:>	Choicelist	Antennas in the receiver's System RAM or as defined in Main Menu: Manage...\Antennas .

Next step

IF the Reference Plane application program	THEN
is to be accessed	CONT (F1) accepts the changes and accesses the Reference Plane application program.
is to be configured	CONF (F2) . Refer to "42.3 Configuring Reference Plane".

42.3

Configuring Reference Plane

Description

Allows options to be set which are used within the Reference Plane application program. These settings are stored within the configuration set.

Access step-by-step

Step	Description
1.	Refer to "42.2 Accessing Reference Plane" to access REFPLANE Reference Plane Begin .
2.	CONF (F2) to access REFPLANE Configuration .

REFPLANE Configuration, Parameters page

This screen consists of the **Parameters** page and the **Logfile** page.

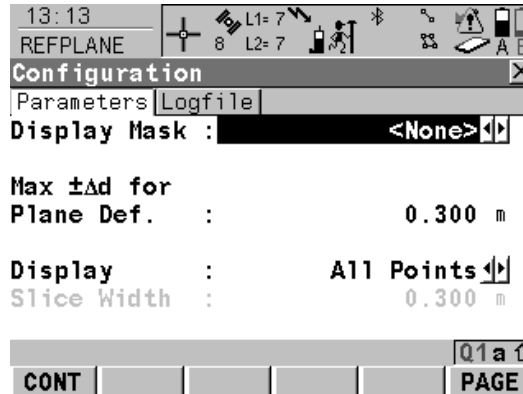

CONT (F1)

To accept changes and return to the screen from where this screen was accessed.

DMASK (F3)

To edit the display mask currently being displayed. Accesses **CONFIGURE Define Display Mask n**. Available when **<Display Mask:>** is highlighted on **Parameters** page. Refer to "19.2 Display Settings".

PAGE (F6)

To change to another page on this screen.

SHIFT ABOUT (F5)

To display information about the application program name, the version number, the date of the version, the copyright and the article number.

Description of fields

Field	Option	Description
<Display Mask:>	Choicelist	The user defined display mask is shown in REFPLANE Measure Points to Plane . All display masks of the active configuration set defined in CONFIGURE Display Settings can be selected.
<Max $\pm\Delta d$ for Plane Def.:>	User input	The maximum perpendicular deviation of a point from the calculated plane.
<Display:>	<p>All Points</p> <p>Points in Slice</p>	<p>This parameter defines the points displayed in the Plot and Map pages of the Reference Plane application program in the plan view.</p> <p><Display: All Points> displays all points in the plan view.</p> <p><Display: Points in Slice> displays points within the defined <Slice Width:> in the plan view.</p>
<Slice Width:>	User input	Available for <Display: Points in Slice >.

Field	Option	Description
		This parameter defines the distance from the plane in which points are displayed. This distance is applied to both sides of the plane. If lines and areas are to be displayed in a particular Map page, then parts of lines and areas falling within the defined slice are also displayed.

Next step

PAGE (F6) changes to the **Logfile** page. Refer to paragraph "REFPLANE Configuration, Logfile page".

REFPLANE Configuration, Logfile page

Description of fields

Field	Option	Description
<Write Logfile:>	Yes or No	To generate a logfile when the application program is exited. A logfile is a file to which data from an application program is written to. It is generated using the selected <Format File:> .
<File Name:>	Choicelist	Available for <Write Logfile: Yes> . The name of the file to which the data should be written. A logfile is stored in the \DATA directory of the active memory device. The data is always appended to the file.

Field	Option	Description
		Opening the choicelist accesses XX Logfiles where a name for a new logfile can be created and an existing logfile can be selected or deleted.
<Format File:>	Choicelist	Available for <Write Logfile: Yes>. A format file defines which and how data is written to a logfile. Format files are created using LGO. A format file must first be transferred from the CompactFlash card to the System RAM before it can be selected. Refer to "26 Tools...\Transfer Objects..." for information on how to transfer a format file. Opening the choicelist accesses XX Format Files where an existing format file can be selected or deleted.

Next step

CONT (F1) returns to the screen from where this screen was accessed.

42.4

Managing Reference Planes

Description

A reference plane is used to measure points relative to the plane.

Measure to plane

- Reference planes can be created, edited, stored and deleted in the active job.
- The reference planes can be recalled for later use.
- The plane can be shifted through a point or a defined offset.

REFPLANE

Choose Task & Reference Plane

13:15 REFPLANE

Choose Task & Reference Plane

Task : Measure to Plane

Plane to Use : **Select From Job**

Ref Plane : Plane001

No. of Points: 3

Std Deviation: ----- m

Max Δd : ----- m

Offset : None

Origin : Instrumnt Coords

Q1 a ↑

CONT

CONT (F1)

To accept changes and to continue with the subsequent screen.

SHIFT CONF (F2)

To configure the reference plane. Refer to "42.3 Configuring Reference Plane".

Description of fields





Field	Option	Description
<Task:>	Measure to Plane	The coordinates of measured points are calculated relative to the reference plane.
<Plane to Use:>	Create New Plane Select From Job	Defines a new reference plane. Reference plane is selected in <Ref Plane:>.
<Ref Plane:>	Choicelist	Available for <Plane to Use: Select From Job >. The reference plane to be used. Accesses REFPLANE Manage Reference Planes .
<No. of Points:>	Output	Available for <Plane to Use: Select From Job >. Number of points used for plane definition for the plane shown in the <Ref Plane:>.
<Std Deviation:>	Output	Standard deviation of used points for plane definition. ----- is displayed for less than four points.
<Max Δd:>	Output	Maximum distance between a point and the calculated plane. ----- is displayed for less than four points.
<Offset:>	Output	The offset method used as defined in REFPLANE XX Reference Plane, Offset page.
<Origin:>	Output	The origin method used as defined in REFPLANE XX Reference Plane, Origin page.



Next step



IF	THEN
a new plane is to be created	CONT (F1) accesses REFPLANE New Reference Plane, General page. Refer to paragraph "Create reference plane step-by-step".
points are to be measured to a plane	CONT (F1) accessses REFPLANE Measure Points to Plane, Reference page. Refer to "42.5 Measuring Points to a Reference Plane".

Create reference plane step-by-step

Step	Description	Refer to chapter
1.	Refer to "42.2 Accessing Reference Plane" to access REFPLANE Reference Plane Begin .	
2.	CONT (F1) to access REFPLANE Choose Task & Reference Plane .	
3.	REFPLANE Choose Task & Reference Plane Select <Plane to Use: Create New Plane> .	
4.	CONT (F1) to access REFPLANE New Reference Plane, General page.  NEW (F2) in REFPLANE Manage Reference Planes to access REFPLANE New Reference Plane, General page.	
5.	REFPLANE New Reference Plane, General page <Ref Plane:> The ID of the new reference plane. <No. of Points:> Number of points used for plane definition.	

Step	Description	Refer to chapter
	<p><Std Deviation:> Standard deviation of used points for plane definition. ----- is displayed unless more than four points are used to define the plane.</p> <p><Max Δd:> Maximum distance between measured point and defined plane. ----- is displayed unless more than four points are used to define the plane.</p>	
6.	PAGE (F6) to change to the Points page.	
7.	<p>REFPLANE New Reference Plane, Points page</p> <p>An * is shown to the right of the point for a point which will be used as origin of the plane.</p> <p>An ! is shown to the left of the point if the point is outside maximum distance between a point and the calculated plane as defined in REFPLANE Configuration, Parameters page.</p> <p>The column Δd(m) displays the perpendicular distance of the point from the definition of the plane.</p>	
	ADD (F2) to add points from REFPLANE Data: Job Name to define the reference plane.	
	USE (F3) to change between Yes and No for the highlighted point.	
	DEL (F4) to remove the highlighted point from the list.	
	<p>SURVY (F5) to measure a point to be used for the plane.</p> <p> DONE (F4) to return to REFPLANE New Reference Plane.</p>	

Step	Description	Refer to chapter
	SHIFT ORIGN (F4) to use the highlighted point as the origin of the plane.	
8.	PAGE (F6) to change to the Origin page.	
9.	<p>REFPLANE New Reference Plane, Origin page</p> <p><Use As Origin: Plane Coords> Point results are additionally stored with X, Y, Z coordinates based on the local plane coordinate system.</p> <p><Use As Origin: Instrumnt Coords> Points on the plane are transformed into the national coordinate system.</p> <p><X-coord:> Available for <Use As Origin: Plane Coords>. Enter local X coordinate of origin. The origin is defined as the projection of the measured point onto the calculated plane.</p> <p><Z-coord:> Available for <Use As Origin: Plane Coords>. Enter local Z coordinate of origin. The origin is defined as the projection of the measured point onto the calculated plane.</p> <p><Point:> Defines the direction of the Y axis.</p>	
	DIREC (F5) Available for <Point:> being highlighted. To access REFPLANE Survey: XX . Measure a point to define the plane direction.	
10.	PAGE (F6) to change to the Offset page.	
11.	<p>REFPLANE New Reference Plane, Offset page</p> <p><Define Offset:> An offset can be defined by a point or a distance. The defined plane is shifted along the Y axis by the offset.</p>	

Step	Description	Refer to chapter
	<p><Offset PtID:> Available for <Define Offset: By Point ID>. Point ID of offset point.</p> <p><Offset:> Distance by which to offset the plane along the Y axis. For <Define Offset: By Distance> the distance can be entered. For <Define Offset: By Point ID> the calculated distance to the adjusted plane is displayed. <Offset:-----> if no values are available.</p>	
	OFFSET (F5) Available for <Offset PtID:> being highlighted. To access REFPLANE Survey: XX, Survey page. Measure a point to define the offset point.	
12.	PAGE (F6) to change to the Plot page.	
13.	<p>REFPLANE New Reference Plane, Plot page</p> <p>Points displayed depend on the settings in REFPLANE Configuration, Parameters page. Points defining the plane are displayed in black, the other points are displayed in grey.</p>	42.3
	<p>SHIFT FACE (F1) to access the face view of the plane.</p> <p> SHIFT PLAN (F1) to access the plan view of the plane.</p>	
14.	STORE (F1) to compute and store the reference plane.	

Edit a reference plane step-by-step

Step	Description
1.	Refer to "42.2 Accessing Reference Plane" to access REFPLANE Reference Plane Begin .

Step	Description
2.	CONT (F1) to access REFPLANE Choose Task & Reference Plane.
3.	REFPLANE Choose Task & Reference Plane Select <Plane to Use: Select From Job> . Highlight <Ref Plane:> .
4.	ENTER to access REFPLANE Manage Reference Planes.
5.	REFPLANE Manage Reference Planes EDIT (F3) to access REFPLANE Edit Reference Plane, General page.
6.	REFPLANE Edit Reference Plane, General page Continue with step 5. from paragraph "Create reference plane step-by-step".

Select a reference plane from the job step-by-step



Step	Description
1.	Refer to "42.2 Accessing Reference Plane" to access REFPLANE Reference Plane Begin.
2.	CONT (F1) to access REFPLANE Choose Task & Reference Plane.
3.	REFPLANE Choose Task & Reference Plane Select <Plane to Use: Select From Job> .
4.	Highlight <Ref Plane:> .
5.	ENTER to access REFPLANE Manage Reference Planes.
6.	REFPLANE Manage Reference Planes Select a reference plane.





Step	Description
	MORE (F5) displays information about date and time of when the reference plane was created and the number of points defining the plane.
7.	CONT (F1) to access REFPLANE Measure Points to Plane, Reference page.

42.5

Measuring Points to a Reference Plane

Measure points to plane step-by-step

Step	Description
1.	Refer to "42.2 Accessing Reference Plane" to access REFPLANE Reference Plane Begin .
2.	CONT (F1) to access REFPLANE Choose Task & Reference Plane .
3.	REFPLANE Choose Task & Reference Plane Select a reference plane. Refer to paragraph "Select a reference plane from the job step-by-step".
4.	CONT (F1) to access REFPLANE Measure Points to Plane, Reference page.
5.	REFPLANE Measure Points to Plane, Reference page <Offset ΔPer d:> The perpendicular distance between current position and adjusted plane. <Offset ΔHt:> The vertical distance between current position and adjusted plane. For <Use As Origin: Plane Coords> <X Coordinate:> , <Y Coordinate:> and <Z Coordinate:> are displayed. For <Use As Origin: Instrumnt Coords> <Easting:> , <Northing:> and <Height:> are displayed.
	CMPR (F4) to calculate offsets to previously measured points.  STORE (F1) to store the results for the point currently being displayed.  DONE (F4) to return to REFPLANE Measure Points to Plane, Reference page.

Step	Description
	PLANE (F5) to edit the selected reference plane.
	SHIFT INDIV (F5) for an individual point ID independent of the ID template. SHIFT RUN (F5) changes back to the next ID from the configured ID template.
6.	PAGE (F6) to change to the Map page.
7.	REFPLANE Measure Points to Plane, Map page.
	SHIFT FACE (F1) to access the face view of the plane.  SHIFT PLAN (F1) to access the plan view of the plane.
8.	OCUPY (F1) to measure points to the plane.

43

Stakeout

43.1

Overview

Description

The Stakeout application program is used to place marks in the field at predetermined points. These predetermined points are the points to be staked. The points to be staked may

- have been uploaded to a job on the receiver using LGO.
- already exist in a job on the receiver.
- have been uploaded from an ASCII file to a job on the receiver using **Main Menu: Convert...Import ASCII/GSI Data to Job.**

A staked point can be manually occupied as a check.

Diagram

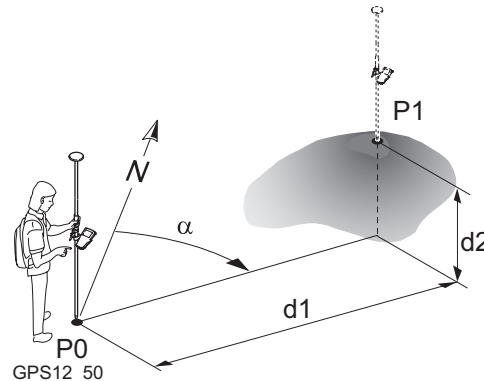

- P0 Current position
- P1 Point to be staked
- d1 Stake out distance
- d2 Height difference between current position and point to be staked
- α Stake out direction

Stakeout modes

Points can be staked using different modes:

- Polar mode.
 - Orthogonal mode.
-



Staking out is possible for **<R-Time Mode: Rover>** and **<R-Time Mode: None>**.



The points to be staked must exist in a job on the active memory device.

Coordinate system

Points cannot be staked if the active coordinate system is different to that in which the points to be staked are stored. For example, the points to be staked are stored with local coordinates and the active coordinate system is WGS 1984.

Point types

It is possible to stake:

- Position only points.
 - Height only points.
 - Points with full sets of coordinates.
-

Height types

Height type of the point to be staked:

Orthometric OR ellipsoidal

Height type computed for current position:

Orthometric OR ellipsoidal depending on the

- configured transformation,
- availability of a geoid model,
- height type of the point to be staked.

If possible, the height type of the point to be staked is computed for the current position.

Height source

Heights can be taken into account from

- the vertical component of a coordinate triplet.
- a **Digital Terrain Model**.

DTM Stakeout must be activated via a licence key. Refer to "30 Tools...\Licence Keys" for information on how to type in the licence key.

If activated, the height of the points to be staked can be edited in the field.

Coding of staked points

Codes can be attached to staked points, lines and areas. Refer to "11 Coding" for information on coding. The behaviour of the coding functionality depends on the definition of a display mask with input fields for coding and attributes.

It may happen that the codes and/or attributes of the staked point and the point to be staked do not match. In this case, a screen opens where they can be corrected. Refer to "11.6 Code and Attribute Mismatch" for information on solving a code and/or attribute mismatch.

Properties of staked points

The properties stored with staked points are:

- Class: Either **MEAS** or **NAV** depending on the position status when the staked point was occupied.
 - Sub class: **GPS Fixed**, **GPS Code Only**, **GNSS Fixed** or **GNSS Code Only**
 - Source: **Stakeout**
 - Instrument source: **GPS**
-

Averaging of staked points

The principles for averaging are identical to those of the Survey application program. Refer to "9.3.4 Mean Page" for information on averaging.

43.2

Accessing Stakeout

Access

Select **Main Menu: Programs... \Stakeout**.

OR

Press **PROG**. Highlight **Stakeout**. **CONT (F1)**. Refer to "36.2 Accessing the Application Programs Menu" for information on the **PROG** key.

OR

Press a hot key configured to access the screen **STAKEOUT Stakeout Begin**. Refer to "6.1 Hot Keys" for information on hot keys.

OR

Press **USER**. Refer to "6.2 USER Key" for information on the **USER** key.

OR

Press **STAKE (F5)** from another application program, for example COGO.

STAKEOUT Stakeout Begin

The screenshot shows the 'Stakeout Begin' screen with the following configuration:

Stakeout Job :	Local Job
Job :	Stake Control
Coord System :	Local
Codelist :	<None>
DTH Job :	<None>
Config Set :	RT_Rov
Antenna :	AX1202 Pole

At the bottom, there are four buttons: **CONT**, **CONF**, and **CSYS**. The **CSYS** button is highlighted with a cursor.

CONT (F1)

To accept changes and access the subsequent screen. The chosen settings become active.

CONF (F2)

To configure Stakeout application program. Accesses **STAKEOUT Configuration**. Refer to "43.3 Configuring Stakeout".

CSYS (F6)

To select a different coordinate system.

Description of fields

Field	Option	Description
<Stakeout Job:>	Choicelist	The job containing the points to be staked. All jobs from Main Menu: Manage...\Jobs can be selected.
<Job:>	Choicelist	The active job. All jobs from Main Menu: Manage...\Jobs can be selected. Points which are occupied after staking out are stored in this job. The original points to be staked are not copied to this job. The data from this job is shown in MANAGE Data: Job Name .
<Coord System:>	Output	The coordinate system currently attached to the selected <Job:>.
<Codelist:>	Choicelist	No codes are stored in the selected <Job:>. All codelists from Main Menu: Manage...\Codelists can be selected.
	Output	Codes have already been stored in the selected <Job:>. If codes had been copied from a System RAM codelist, then the name of the codelist is displayed. If codes have not been copied from a System RAM codelist but typed in manually, then the name of the active job is displayed.

Field	Option	Description
<DTM Job:>	Choicelist	Available for <Use DTM: DTM only> and <Use DTM: DTM & Stake Job> in STAKEOUT Configuration, Heights page. To select a DTM to be staked and to select the active DTM layer to be used. Heights are then staked out relative to the selected DTM. Refer to "43.4.4 Staking Out a DTM".
<Config Set:>	Choicelist	The active configuration set. All configuration sets from Main Menu: Manage... \Configuration Sets can be selected. Configuration sets with <R-Time Mode: Reference> cannot be used in the Stakeout application program.
<Antenna:>	Choicelist	The antenna currently defined to be used in the selected configuration set. All antennas from Main Menu: Manage... \Antennas can be selected.

Next step

IF the Stakeout application program	THEN
is to be accessed	CONT (F1) accepts the changes and accesses Stakeout application program. Refer to "43.4 Staking Out".
is to be configured	CONF (F2) . Refer to "43.3 Configuring Stakeout".

43.3

Configuring Stakeout

Access

Select **Main Menu: Programs...\Stakeout**. In **STAKEOUT Stakeout Begin** press **CONF (F2)** to access **STAKEOUT Configuration**.

OR

Press **PROG**. Highlight **Stakeout**. **CONT (F1)**. In **STAKEOUT Stakeout Begin** press **CONF (F2)** to access **STAKEOUT Configuration**.

OR

Press **SHIFT CONF (F2)** in **STAKEOUT XX Stakeout**.

STAKEOUT Configuration, General page

This screen consists of the **General** page, the **Checks** page, the **Heights** page and the **Logfile** page. The explanations for the softkeys given below are valid for all pages, unless otherwise stated.

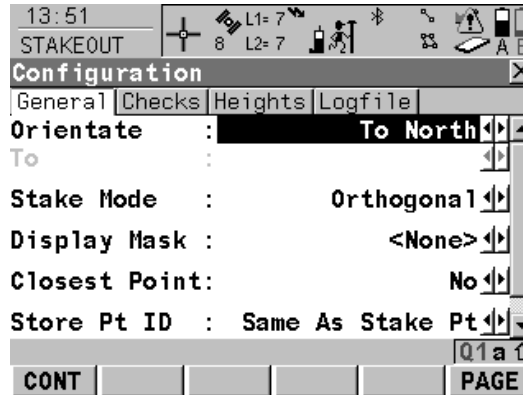

CONT (F1)

To accept changes and return to the screen from where this screen was accessed.

DMASK (F3)

To edit the display mask currently being displayed in this field. Accesses **CONFIGURE Define Display Mask n**. Available for **<Display Mask:>** being highlighted on **General** page. Refer to "19.2 Display Settings".

PAGE (F6)

To change to another page on this screen.

SHIFT ABOUT (F5)

To display information about the program name, the version number, the date of the version, the copyright and the article number.

Description of fields

Field	Option	Description
<Orientate:>		The reference direction to be used to stakeout points. The stakeout elements and the graphical display shown in the Stakeout application program are based on this selection.
	To North	The North direction shown in the graphical display based on the active coordinate system.
	To Sun	The position of the sun calculated from the current position, the time and the date.
	To Last Point	Timewise the last recorded point. If no points are yet staked, <Orientate: To North> is used for the first point to be staked.
	To Point(Stake)	A point from <Stakeout Job:> selected in STAKEOUT Stakeout Begin .
	To Point(Store)	A point from <Job:> selected in STAKEOUT Stakeout Begin .

Field	Option	Description
	To Line(Stake)	The direction of the orientation is parallel to a reference line from <Stakeout Job:> selected in STAKEOUT Stakeout Begin . Open the listbox to create, edit or delete a reference line.
	To Line(Store)	The direction of the orientation is parallel to a reference line from <Job:> selected in STAKEOUT Stakeout Begin . Open the listbox to create, edit or delete a reference line.
	To Arrow	The direction of the orientation is from the current position to the point to be staked. The graphical display shows an arrow pointing in the direction of the point to be staked.
<To:>	Choicelist	Available for <Orientate: To Point(Stake)> , <Orientate: To Point(Store)> , <Orientate: To Line(Stake)> and <Orientate: To Line(Store)> . To select the point or line to be used for orientation. Refer to "9.2 Accessing Data Management" for information on creating, editing and deleting a known point. Refer to "41.4 Managing Reference Lines/Arcs" for information on creating, editing and deleting a line.
<Stake Mode:>	Polar	The method of staking out. The direction from the orientation reference, the horizontal distance and the cut/fill is displayed.

Field	Option	Description
	Orthogonal	The distance forwards to/backwards from the point, the distance right/left to the point and the cut/fill is displayed.
<Display Mask:>	Choicelist	The user defined display mask to be shown in STAKEOUT XX Stakeout . All display masks of the active configuration set defined in CONFIGURE Display Settings can be selected.
<Closest Point:>	Yes	The order of the points suggested for staking out. After staking and storing a point, the next point suggested for staking out is the point closest to the point which was staked. If there are many points in <Stakeout Job:> , the search may take a few seconds.
	No	After staking and storing one point, the next point suggested for staking out is the subsequent one in <Stakeout Job:> .
<Store Pt ID:>	Same as Stake Pt	The staked points are stored with the same point ID's as the points to be staked.
	Prefix	Adds the setting for <Prefix/Suffix:> in front of the original point ID's.
	Suffix	Adds the setting for <Prefix/Suffix:> at the end of the original point ID's.

Field	Option	Description
<Prefix/Suffix:> >	User input	Available for <Store Pt ID: Prefix> and <Store Pt ID: Suffix>. The identifier with up to four characters is added in front of or at the end of the ID of the staked point.

Next step

PAGE (F6) changes to the **Checks** page. Refer to paragraph "STAKEOUT Configuration, Checks page".

**STAKEOUT
Configuration,
Checks page**
Description of fields

Field	Option	Description
<Pos Check:>	Yes or No	Allows a check to be made on the horizontal coordinate difference between the staked point and the point to be staked. If the defined <Pos Limit:> is exceeded, the stakeout can be repeated, skipped or stored.
<Pos Limit:>	User input	Available for <Pos Check: Yes>. Sets the maximum horizontal coordinate difference accepted in the position check.
<Height Check:>	Yes or No	Allows a check to be made on the vertical difference between the staked point and the point to be staked. If the defined <Height Limit:> is exceeded, the stakeout can be repeated, skipped or stored.

Field	Option	Description
<Height Limit:>	User input	Available for <Height Check: Yes>. Sets the maximum vertical difference accepted in the height check.
<Beep near Pt:>	Yes or No	The receiver beeps when the horizontal radial distance from the current position to the point to be staked is equal to or less than defined in <Dist from Pt:>.
<Dist from Pt:>	User input	Available for <Beep near Pt: Yes>. The horizontal radial distance from the current position to the point to be staked when a beep should be heard.

Next step

PAGE (F6) changes to the **Heights** page. Refer to paragraph "STAKEOUT Configuration, Heights page".

STAKEOUT Configuration, Heights page

Description of fields

Field	Option	Description
<Height Offset:>	User input	Allows a constant height offset to be applied to the height of the points or DTM being staked.
<Edit Height:>	Yes	The field <D Ht:> for the design height is displayed in STAKEOUT Orthogonal Stakeout, Stake page and STAKEOUT Polar Stakeout, Stake page. The design height is the height of the point to be staked. The value for <D Ht:> can be changed.

Field	Option	Description
	No	The field <Ht:> for the height of the current position is displayed in STAKEOUT Orthogonal Stakeout, Stake page and STAKEOUT Polar Stakeout, Stake page. The value for <Ht:> cannot be changed.
<Use DTM:>	No	Available if DTM Stakeout has been activated via a licence key. Refer to "30 Tools...\Licence Keys" for information on how to type in or upload the licence key. Available unless STAKEOUT Configuration, Heights page was accessed while being within the Stakeout application program. No DTM file is used. The positions and heights of points in the selected <Stakeout Job:> are staked out.
	DTM only	Activates the stakeout of heights without positions. Heights relative to the selected <DTM Job:> are staked out.
	DTM & Stake Job	The positions of points in the selected <Stakeout Job:> are staked out. Heights to be staked out are taken from <DTM Job:>.

Next step

PAGE (F6) changes to the **Logfile** page. Refer to paragraph "STAKEOUT Configuration, Logfile page".

**STAKEOUT
Configuration,
Logfile page**

Description of fields

Field	Option	Description
<Write Logfile:>	Yes or No	To generate a logfile when the application program is exited. A logfile is a file to which data from an application program is written to. It is generated using the selected <Format File:> .
<File Name:>	Choicelist	Available for <Write Logfile: Yes> . The name of the file to which the data should be written. A logfile is stored in the \DATA directory of the active memory device. The data is always appended to the file. Opening the choicelist accesses XX Logfiles where a name for a new logfile can be created and an existing logfile can be selected or deleted.
<Format File:>	Choicelist	Available for <Write Logfile: Yes> . A format file defines which and how data is written to a logfile. Format files are created using LGO. A format file must first be transferred from the CompactFlash card to the System RAM before it can be selected. Refer to "26 Tools...\Transfer Objects..." for information on how to transfer a format file. Opening the choicelist accesses MANAGE XX where an existing format file can be selected or deleted.

Next step

PAGE (F6) changes to the first page on this screen.

43.4

Staking Out

43.4.1











Elements of the Graphical Display in the Stakeout

Description

A graphical display provides a guide to find the point to be staked out. The elements of the graphical display used within the Stakeout application program screens are explained in this chapter. Some of the elements depend on the selection for **<Orientate:>** in **STAKEOUT Configuration, General** page. Other elements are commonly displayed.

The **Map** page provides an interactive display of the data. Refer to "32.5 Map Mode" for information on the functionality and softkeys available.

Elements of graphical display

	Rover		Arrow; short arrow when within 1 m of the point to be staked
	Point to be staked		North arrow
	North		Current scale
	Sun		
	Last or known point		
	Line within scale. The orientation of the line is from the first to the second point. This is from the bottom to the top of screen.		
	Line, out off scale		

Graphical display

If the antenna is too far away and the scale is >1000 m, the antenna is not shown and the point to be staked circle is grey.

Standard graphical display

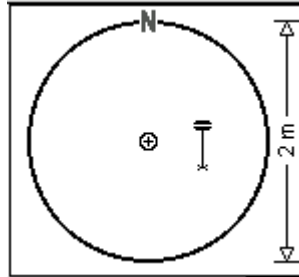

Reversed graphical display

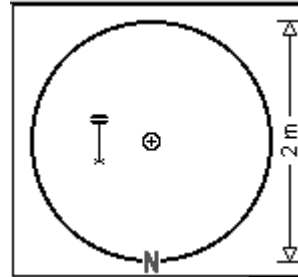

For scale 0.5 m

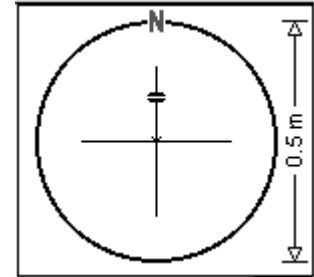

43.4.2

Staking Out in Orthogonal Mode

Description

The stakeout elements are a horizontal distance forwards/backwards, a horizontal distance right/left and a cut/fill. The values are calculated from the current position to the point to be staked.

Diagram

The diagram shows an example for stake out in orthogonal mode with **<Orientate: To North>**.

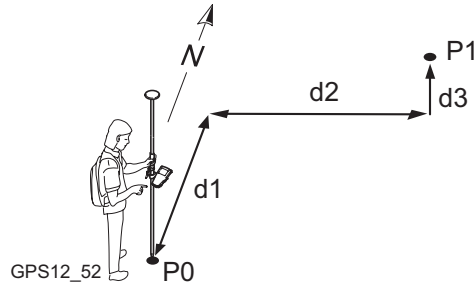

- P0 Current position
- P1 Point to be staked
- d1 **<FORW:>** or **<BACK:>**
- d2 **<RGHT:>** or **<LEFT:>**
- d3 **<FILL:>** or **<CUT:>**



<Stake Mode: Orthogonal> is configured in **STAKEOUT Configuration, General** page. Refer to "43.3 Configuring Stakeout".

Access

Refer to "43.2 Accessing Stakeout" to access **STAKEOUT Orthogonal Stakeout**.

STAKEOUT Orthogonal Stakeout, Stake page

The pages shown are those from a typical configuration set. An additional page is available when a user defined display mask is used.

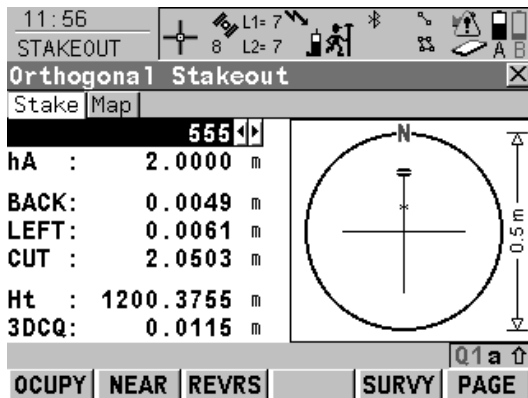

OCUPY (F1)

To start measuring the point being staked. The position mode icon changes to the static icon. (F1) changes to **STOP**. The difference between the current position and the point being staked is still displayed.

STOP (F1)

To end measuring the point being staked. When **<Auto STOP: Yes>** in **CONFIGURE Point Occupation Settings**, recording of positions ends automatically as defined by the stop criteria. The position mode icon changes to the moving icon. (F1) changes to **STORE**. After ending the measurements, the differences between the measured point and the point to be staked are displayed.

STORE (F1)

To store the measured point. When **<Auto STORE: Yes>** in **CONFIGURE Point Occupation Settings**, the measured point is stored automatically. (F1) changes to **OCUPY**.

NEAR (F2)

To search <**Stakeout Job**> for the point nearest to the current position when the key is pressed. The point is selected as the point to be staked and is displayed in the first field on the screen. After staking and storing the nearest point, the next point suggested for staking out is the one which was suggested before the key was pressed.

Available when **OCUPY (F1)** is displayed.

REVR (F3)

To reverse the graphical display top to bottom. A reversed graphical display can be used when the point to be staked lies behind the current position.

SURVY (F5)

To survey additional points which may be needed during staking out. To return to Stakeout application program, press **SHIFT QUIT (F6)** or **ESC**.

Available for **OCUPY (F1)** being displayed.

PAGE (F6)

To change to another page on this screen.

SHIFT CONF (F2)

To configure the Stakeout application program. Available for **OCUPY (F1)** being displayed. Refer to "43.3 Configuring Stakeout".

SHIFT CONEC (F3) and SHIFT DISCO (F3)

To dial the number of the reference station configured in the active configuration set and to hang up immediately after the survey is completed. Available for **OCUPY (F1)** or **STORE (F1)** being displayed and for real-time devices of type digital cellular phone or modem. Available for **<Auto CONEC: No>** in **CONFIGURE GSM Connection**.

SHIFT INIT (F4)

To select an initialisation method and to force a new initialisation. Available for **OCUPY (F1)** or **STORE (F1)** being displayed and for configuration sets allowing phase fixed solutions. Refer to "44.6.2 Accessing Initialisation for Real-Time Rover Operations".

SHIFT QUIT (F6)

To exit Stakeout application program. Available for **OCUPY (F1)** being displayed.

Description of fields

Field	Option	Description
First field on the screen	Choicelist	The point ID of the point to be staked. Accesses STAKEOUT Data: Job Name where points are shown according to sort and filter settings and staked points are indicated by the staked out symbol  .

Field	Option	Description
<hA:>	User input	The default antenna height as defined in the active configuration set is suggested. Refer to "2.3 Determining Antenna Heights". Changing the antenna height here does not update the default antenna height as defined in the active configuration set. The changed antenna height is used until the application program is exited.
<FORW:>	Output	The horizontal distance from the current position to the point to be staked in the direction of the orientation.
<BACK:>	Output	The horizontal distance from the current position to the point to be staked in the reverse direction of the orientation.
<RGHT:>	Output	Horizontal distance from the current position to the point to be staked orthogonal to the right of the orientation direction.
<LEFT:>	Output	Horizontal distance from the current position to the point to be staked orthogonal to the left of the orientation direction.
<CUT:>	Output	The negative height difference from the height of the current position to the height of the point to be staked. The value for <Height Offset:> configured in STAKEOUT Configuration, Heights page is taken into account. To move down.

Field	Option	Description
<FILL:>	Output	The positive height difference from the height of the current position to the height of the point to be staked. The value for <Height Offset:> configured in STAKEOUT Configuration, Heights page is taken into account. To move up.
<Ht:>	Output	Available for <Edit Height: No> in STAKEOUT Configuration, Heights page. The orthometric height of the current position is displayed. If the orthometric height cannot be displayed, the local ellipsoidal height is displayed. If it is not possible to display the local ellipsoidal height, the WGS 1984 height is displayed. The value for <Height Offset:> configured in STAKEOUT Configuration, Heights page is taken into account.
<D Ht:>	User input	Available for <Edit Height: Yes> in STAKEOUT Configuration, Heights page. The design height, which is the orthometric height of the point to be staked, is displayed. If the orthometric height cannot be displayed, the local ellipsoidal height is displayed. If it is not possible to display the local ellipsoidal height, the WGS 1984 height is displayed. The value for <Height Offset:> configured in STAKEOUT Configuration, Heights page is not taken into account.

Field	Option	Description
		Changing the value for <D Ht:> changes the values displayed for <CUT:> and <FILL:>.
<3DCQ:>	Output	Available for code and phase fixed solutions. The current 3D coordinate quality of the computed position.
<PDOP:>	Output	Available for autonomous solutions or if no solution is available. The current PDOP of the autonomous solution.

Next step

PAGE (F6) changes to the **Map** page. Refer to paragraph "STAKEOUT Orthogonal Stakeout, Map page".

STAKEOUT Orthogonal Stakeout, Map page



The **Map** page provides an interactive display of the data. Refer to "32 MapView Interactive Display Feature" for information on the functionality and softkeys available.





Next step

PAGE (F6) changes to the first page on this screen.

Stake out in orthogonal mode step-by-step

In the Stakeout application program, the behaviour of the icons is as for a real-time survey. The following table explains the most common settings. Refer to the stated chapter for more information on screens.

Step	Description	Refer to chapter
1.	Set up all equipment as for a real-time operation.	1
2.	Start the Stakeout application program.	43.2
3.	STAKEOUT Stakeout Begin Check the settings.	43.2
4.	CONF (F2)	
5.	STAKEOUT Configuration, General page <Stake Mode: Orthogonal>	43.3
	This step-by-step instruction uses typical settings in all other fields on all pages in STAKEOUT Configuration .	43.3
6.	CONT (F1)	
7.	CONT (F1) to access STAKEOUT Orthogonal Stakeout .	
8.	STAKEOUT Orthogonal Stakeout, Stake page Check the point ID and the antenna height.	
	NEAR (F2) to search <Stakeout Job:> for the point nearest to the current position when the key is pressed.	
9.	Wait until the ambiguities are solved. This is indicated by the position status icon.	
	When working with code only corrections, an ambiguity solution is not attempted.	
10.	Orientate to North.	

Step	Description	Refer to chapter
11.	Move to the point to be staked either by following the values in the fields <FORW:>, <BACK:>, <RGHT:> and <LEFT:> or the graphical display.	
	When the value is at or nearly zero, the current position is the point to be staked.	
12.	Mark the current position for example with a peg.	
	The height difference from <CUT:> or <FILL:> may be written on the peg.	
13.	Hold the antenna steady over the marker.	
14.	OCUPY (F1) starts measuring the point.	
	The value for the stakeout elements still show the difference between the current position and the point to be staked.	
15.	When <Auto STOP: No> in CONFIGURE Point Occupation Settings , STOP (F1) when enough data is collected. At least one epoch of data must be recorded.	19.6.1
	For <Pos Check: Yes> and/or <Height Check: Yes> in STAKEOUT Configuration, Checks page, a check is made on the horizontal and/or vertical coordinate distance from the staked point to the point to be staked. If either of the configured difference limits are exceeded, STAKEOUT Difference Limit Exceeded is accessed.	43.4.5
16.	When <Auto STORE: No> in CONFIGURE Point Occupation Settings , STORE (F1) to store the point information.	19.6.1

Step	Description	Refer to chapter
17.	Are more points to be staked? <ul style="list-style-type: none">• If yes, continue with step 18.• If no, continue with step 20.	
18.	STAKEOUT Polar Stakeout, Stake page According to sort and filter settings, the subsequent point in <Stakeout Job:> is suggested for staking out.	
19.	Repeat steps 8. to 17.	
20.	SHIFT QUIT (F6) to return to the screen from where STAKEOUT Stakeout Begin was accessed.	

43.4.3

Staking Out in Polar Mode

Description

The stakeout elements are a direction from the orientation reference, a horizontal distance and a cut/fill. The value is calculated from the current position to the point to be staked.

Diagram

This diagram shows an example for stake out in polar mode with **<Orientate: To North>**.

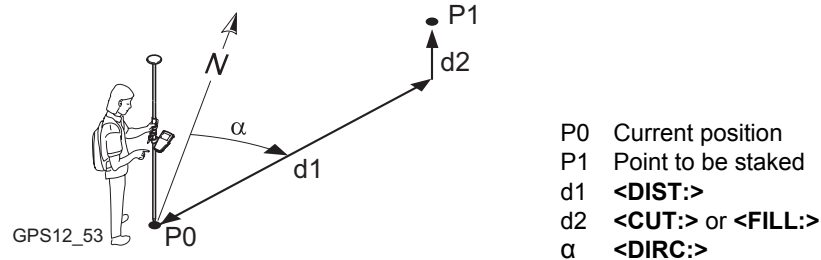

<Stake Mode: Polar> is configured in **STAKEOUT Configuration, General** page. Refer to "43.3 Configuring Stakeout".

Access

Refer to "43.2 Accessing Stakeout" to access **STAKEOUT Polar Stakeout**.

STAKEOUT Polar Stakeout, Stake page

The pages shown are those from a typical configuration set. An additional page is available when a user defined display mask is used.

The keys are identical with those in **STAKEOUT Orthogonal Stakeout, Stake** page. Refer to "43.4.2 Staking Out in Orthogonal Mode" for information on the keys.

Description of fields

Field	Option	Description
First field on the screen	Choicelist	The point ID of the point to be staked. Accesses STAKEOUT Data: Job Name where points are shown according to sort and filter settings and staked points are indicated by the staked out symbol  .
<hA:>	User input	The default antenna height as defined in the active configuration set is suggested. Refer to "2.3 Determining Antenna Heights". Changing the antenna height here does not update the default antenna height as defined in the active configuration set. The changed antenna height is used until the application program is exited.
<DIRC:>	Output	The bearing from the direction of the orientation to the point to be staked seen from the current position.
<DIST:>	Output	Horizontal distance from the current position to the point to be staked.
<CUT:>	Output	The negative height difference from the height of the current position to the height of the point to be staked. The value for <Height Offset:> configured in STAKEOUT Configuration, Heights page is taken into account. To move down.

Field	Option	Description
<FILL:>	Output	The positive height difference from the height of the current position to the height of the point to be staked. The value for <Height Offset:> configured in STAKEOUT Configuration, Heights page is taken into account. To move up.
<Ht:>	Output	Available for <Edit Height: No> in STAKEOUT Configuration, Heights page. The orthometric height of the current position is displayed. If the orthometric height cannot be displayed, the local ellipsoidal height is displayed. If it is not possible to display the local ellipsoidal height, the WGS 1984 height is displayed. The value for <Height Offset:> configured in STAKEOUT Configuration, Heights page is taken into account.
<D Ht:>	User input	Available for <Edit Height: Yes> in STAKEOUT Configuration, Heights page. The design height, which is the orthometric height of the point to be staked, is displayed. If the orthometric height cannot be displayed, the local ellipsoidal height is displayed. If it is not possible to display the local ellipsoidal height, the WGS 1984 height is displayed. The value for <Height Offset:> configured in STAKEOUT Configuration, Heights page is not taken into account.

Field	Option	Description
		Changing the value for <D Ht:> changes the values displayed for <CUT:> and <FILL:> .
<3DCQ:>	Output	Available for code and phase fixed solutions. The current 3D coordinate quality of the computed position.
<PDOP:>	Output	Available for autonomous solutions or if no solution is available. The current PDOP of the autonomous solution.

Next step

PAGE (F6) changes to the **Map** page. Refer to paragraph "STAKEOUT Orthogonal Stakeout, Map page".

**STAKEOUT
Polar Stakeout,
Map page**

The **Map** page provides an interactive display of the data. Refer to "32 MapView Interactive Display Feature" for information on the functionality and softkeys available.

Next step

PAGE (F6) changes to the first page on this screen.

**Stake out in polar mode
step-by-step**

The steps are identical to those of staking out in orthogonal mode. Refer to "43.4.2 Staking Out in Orthogonal Mode". Follow the instructions in paragraph "Stake out in orthogonal mode step-by-step" using **<Stake Mode: Polar>**. The values are displayed as **<DIRC:>** and **<DIST:>**.

43.4.4

Staking Out a DTM

Description

With the Stakeout application program a **D**igital **T**errain **M**odel can be staked. The heights of the current positions are compared against those of a selected DTM job. The height differences are calculated and displayed.

Staking a DTM may be used for

- staking out where the DTM represents the surface to be staked.
- quality control purposes where the DTM represents the final project surface.

DTM jobs are created in LGO. DTM jobs are stored in the \DBX directory on the active memory device.

Diagram

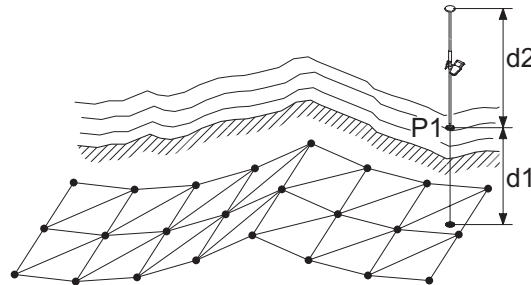







GPS12_108

P1 Point to be staked
d1 Antenna height
d2 <CUT:> or <FILL:>

Stake out a DTM step-by-step

The following table explains the most common settings. Refer to the stated chapter for more information on screens.

Step	Description	Refer to chapter
	DTM Stakeout must be activated via a licence key.	30
	The DTM job to be used must be stored in the \DBX directory on the active memory device.	
1.	Start the Stakeout application program.	43.2
2.	STAKEOUT Stakeout Begin CONF (F2) to access STAKEOUT Configuration .	
3.	PAGE (F6) until the Heights page is active.	
4.	STAKEOUT Configuration, Heights page <Use DTM: DTM only>	43.3
	<Use DTM: DTM & Stake Job> is not covered in this step-by-step instruction. The stake out procedure is identical as for the polar or orthogonal mode but the heights to be staked are taken from the selected <DTM Job:> defined in STAKEOUT Stakeout Begin .	43.3
	This step-by-step instruction uses typical settings in all other fields on all pages in STAKEOUT Configuration . The selection for <Stake Mode:> is irrelevant since no positions are staked.	43.3
5.	CONT (F1)	
6.	STAKEOUT Stakeout Begin <DTM Job:> Select a DTM job. Check the other settings.	43.2

Step	Description	Refer to chapter
7.	CONT (F1) to access STAKEOUT DTM Stakeout .	
8.	STAKEOUT DTM Stakeout, Stake page Check the suggested antenna height.	
9.	Wait until the ambiguities are solved. This is indicated by the position status icon.	
	When working with code only corrections, an ambiguity solution is not attempted.	
10.	STAKEOUT DTM Stakeout, Stake page <CUT:> or <FILL:> The negative or positive height differences from the current position to the equivalent point in the selected DTM job is calculated and displayed. Height offsets apply.	
11.	Mark the current position for example with a peg.	
	The height difference from <CUT:> or <FILL:> may be written on the peg.	
12.	OCUPY (F1) starts collecting data.	
	The height difference is still shown.	
13.	When <Auto STOP: No> in CONFIGURE Point Occupation Settings, STOP (F1) when enough data is collected. At least one epoch of data must be recorded.	19.6.1

Step	Description	Refer to chapter
	For < Height Check: Yes > in STAKEOUT Configuration, Checks page, a check is made on the vertical coordinate distance from the staked point to the point to be staked. If the configured difference limit is exceeded, STAKEOUT Difference Limit Exceeded is accessed.	43.4.5
14.	When < Auto STORE: No > in CONFIGURE Point Occupation Settings, STORE (F1) to store the point information.	19.6.1
15.	Are more heights to be staked? <ul style="list-style-type: none"> • If yes, move to the next position and repeat steps 8. to 15. • If no, continue with step 16. 	
16.	SHIFT QUIT (F6) to return to the screen from where STAKEOUT Stakeout Begin was accessed.	

43.4.5

Stakeout Difference Limit Exceeded

Description

If configured a check is made on the horizontal and/or vertical coordinate distance from the staked point to the point to be staked. Refer to "43.3 Configuring Stakeout" for information on configuring the check and the limits.

Access

The screen shown below is accessed automatically when the point is stored if either of the configured difference limits are exceeded.

STAKEOUT Difference Limit Exceeded

The availability of the fields depends on the configured **<Stake Mode:>** and **<Use DTM:>**. For example for **<Use DTM: DTM only>**, position relevant fields are unavailable.

The limits that have been exceeded are shown in bold and indicated by a ?.

Field	Value	Unit
Point ID	555	
Store ID	555	
BACK	0.0019	m
LEFT	0.0021	m
CUT	2.0530	m
2D-Diff	0.0028	m
3D-Diff	2.0530	m

BACK (F1)

To return to **STAKEOUT XX Stakeout** without storing the point. Staking out of the same point continues.

STORE (F3)

To accept the coordinate differences, store the point information and return to **STAKEOUT XX Stakeout**.

SKIP (F4)

To return to **STAKEOUT XX Stakeout** without storing the point. According to filter and sort settings the subsequent point in **<Stakeout Job:>** is suggested for staking out.

Description of fields

Field	Option	Description
<Point ID:>	Output	The point ID of the point to be staked.
<Store ID:>	User input	The unique number which is used to store the staked point. Allows a different point ID to be typed in if needed.
< Δ BEARING:>	Output	The bearing from the staked point to the point to be staked.
< Δ DISTANCE:>	Output	Horizontal distance from the staked point to the point to be staked.
<FORW:>	Output	The horizontal distance from the current position to the point to be staked in the direction of the orientation.
<BACK:>	Output	The horizontal distance from the current position to the point to be staked in the reverse direction of the orientation.
<RGHT:>	Output	Horizontal distance from the staked point to the point to be staked orthogonal to the right of the orientation direction.
<LEFT:>	Output	Horizontal distance from the staked point to the point to be staked orthogonal to the left of the orientation direction.

Field	Option	Description
<CUT:>	Output	The negative height difference from the height of the staked point to the height of the point to be staked. To move down.
<FILL:>	Output	The positive height difference from the height of the staked point to the height of the point to be staked. To move up.
<2D-Diff:>	Output	Displays the horizontal difference from the staked point to the point to be staked.
<3D-Diff:>	Output	Displays the spatial difference from the staked point to the point to be staked.

Next step

IF the exceeded difference limit	THEN
is not to be accepted	BACK (F1) to stake the same point again.
is to be accepted	STORE (F3) to store the point and to stake out the next point.
is not to be accepted but cannot be improved	SKIP (F4) to skip staking this point and to stake out the next point.

44**Survey - General**

44.1**Accessing Survey**

Access

Select **Main Menu: Survey**.

OR

Select **Main Menu: Programs...\Survey**.

OR

Press a hot key configured to access the screen **SURVEY Survey Begin**. Refer to "6.1 Hot Keys" for information on hot keys.

OR

Press **USER**. Refer to "6.2 USER Key" for information on the **USER** key.

OR

Press **PROG**. Highlight **Survey. CONT (F1)**. Refer to "36.2 Accessing the Application Programs Menu" for information on the **PROG** key.

SURVEY Survey Begin

11:57 SURVEY

Survey Begin

Job : Job2

Coord System : WGS 1984

Codelist : <None>

Config Set : RTK Rover

Antenna : AX1202 Pole

Q1 a ↑

CONT CONF CSYS

CONT (F1)

To accept changes and access the subsequent screen. The chosen settings become active.

CONF (F2)

Available for <R-Time Mode: None> and <R-Time Mode: Rover>. To configure Smart-Codes, auto points and hidden point measurements. Accesses **SURVEY Configuration**. Refer to "45 Survey - Auto Points" and "46 Survey - Hidden Points" for information on the fields and keys.

CSYS (F6)

To select a different coordinate system.

Description of fields

Field	Option	Description
<Job:>	Choicelist	The active job. All jobs from Main Menu: Manage...\Jobs can be selected.
<Coord System:>	Output	The coordinate system currently attached to the selected <Job:>.
<Codelist:>	Choicelist	No codes are stored in the selected <Job:>. All codelists from Main Menu: Manage...\Codelists can be selected.

Field	Option	Description
	Output	Codes have already been stored in the selected <Job:> . If codes had been copied from a System RAM codelist, then the name of the codelist is displayed. If codes have not been copied from a System RAM codelist but typed in manually, then the name of the active job is displayed.
<Config Set:>	Choicelist	The active configuration set. All configuration sets from Main Menu: Manage...\Configuration Sets can be selected. The selection for <R-Time Mode:> in the configuration set determines the subsequent screen.
<Antenna:>	Choicelist	The antenna currently defined in the selected configuration set. All antennas from Main Menu: Manage...\Antennas can be selected.

Next step

IF surveying	THEN
points with <R-Time Mode: None>	CONT (F1) accepts the changes and accesses SURVEY Survey: Job Name . Refer to "44.3.1 Post-Processed Kinematic and Static Operations".
points with <R-Time Mode: Reference>	CONT (F1) accepts the changes and accesses SURVEY Set Up Reference Station . Refer to "44.3.2 Real-Time Reference Operations".

IF surveying	THEN
points with <R-Time Mode: Rover>	CONT (F1) accepts the changes and accesses SURVEY Survey: Job Name . Refer to "44.3.3 Real-Time Rover Operations".
lines or areas	Refer to "9.4 Line/Area Management".

44.2

GPS Surveying Techniques

Description

Depending on the surveying task and the receivers being used, certain GPS surveying techniques are possible. The three existing types of GPS surveying techniques are:

- Static
- Post-processed kinematic, rover
- Real-time, reference and rover

GPS surveying techniques

The following table explains the three existing GPS surveying techniques.

GPS surveying technique	Characteristic	Description
Static	Way of working	<ul style="list-style-type: none"> • Reference set up over a point with accurately known coordinates. • Rover set up over a point with known or unknown coordinates. • Data recorded at both receivers simultaneously at the same data rate, typically 15, 30 or 60 s. • Post-processing is compulsory.
	Use	For long baselines, geodetic networks, tectonic plate studies.
	Accuracy	High over long and very long baselines.
	Working speed	Slow

GPS surveying technique	Characteristic	Description
Post-processed kinematic	Way of working	<ul style="list-style-type: none"> • Reference set up as static over a point with accurately known coordinates. • Rover moves from one point to another. The receiver remains turned on while moving. • Static and moving raw observations are collected. • Post-processing is compulsory.
	Use	For detail surveys and measuring many points in quick succession.
	Accuracy	High for baselines up to 30 km.
	Working speed	Very efficient for surveying many points that are close together.
Real-time, reference and rover	Way of working	<ul style="list-style-type: none"> • Reference set up as static over a point with accurately known coordinates in WGS 1984. • Rover equipment is set up on a pole and moves from one unknown point to another. • A data link, for example a radio or digital cellular phone, transmits satellite data from the reference to the rover.

GPS surveying technique	Characteristic	Description
		<ul style="list-style-type: none"> Data coming from the reference and GPS signals received on the rover are processed together on the rover as the survey is carried out in real time. Ambiguities are solved, coordinates of the surveyed points are calculated and displayed. Application programs as on a conventional instruments like stakeout or COGO can be performed. Post-processing is optional.
	Use	For surveying detail with many points in one area.
	Accuracy	High for baselines up to 30 km.
	Working speed	Very efficient as the results are generated in the field.



GPS surveying techniques depending on receivers

Refer to standard surveying literature for more details on GPS surveying techniques.

The type of receiver in use determines the GPS surveying techniques that can be carried out.

Receiver	Static	Post-processed kinematic	Real-time DGPS	Real-time
GX1210	x	x initialisation while static	-	-
GX1210 with DGPS/RTCM vX.X option	x	x initialisation while static	x	-

Receiver	Static	Post-processed kinematic	Real-time DGPS	Real-time
GX1220	x	x initialisation while moving	-	-
GX1220 with DGPS/RTCM vX.X option	x	x initialisation while moving	x	-
GX1220 GG	x	x initialisation while moving	-	-
GX1220 GG with DGPS/RTCM vX.X option	x	x initialisation while moving	x	-
GX1230	x	x initialisation while moving	x	x
GX1230 GG	x	x initialisation while moving	x	x

44.3

Surveying Points

44.3.1

Post-Processed Kinematic and Static Operations

Description



Refer to "44.2 GPS Surveying Techniques" for information on static and post-processed kinematic surveying techniques.

Requirements

- A typical configuration set for a static or post-processed kinematic operation is used.
- **<R-Time Mode: None>** in **CONFIGURE Real-Time Mode**.

Access step-by-step

The table describes the main access to **SURVEY Survey: Job Name**. Access is possible from other screens where individual point measurements are needed, for example from **COGO Inverse** with **SURVY (F5)**.

Step	Description
1.	Refer to "44.1 Accessing Survey" to access SURVEY Survey Begin .
2.	In SURVEY Survey Begin select a job.
3.	Select a typical configuration set with <R-Time Mode: None> .
4.	Select an antenna.
5.	CONT (F1) to access SURVEY Survey: Job Name .
	The position mode icon is the moving icon. This indicates that the antenna can be moved around and that no static observations are being recorded.
	If configured for post-processed kinematic operations, the logging of moving observations begins. This is also indicated in the position mode icon.

SURVEY

Survey: Job Name, Survey page

The fields shown are those from a typical configuration set for static or post-processed kinematic operations. The screen described consists of the **Survey** page and the **Map** page. The explanations for the softkeys given below are valid for the **Survey** page. Refer to "32 MapView Interactive Display Feature" for information on the keys on the **Map** page. The fields and functionality of this screen vary slightly when accessed from other application programs where individual point measurements are needed.

18:14
SURVEY
Survey: Job2
Survey Code Annot Map
Point ID : 100
Antenna Ht : 1.382 m
3D CQ : 3.614 m
OCUPY NEAR H PNT PAGE

OCUPY (F1)

To start logging of static observations. The position mode icon changes to the static icon. (F1) changes to **STOP**.

STOP (F1)

To end logging of static observations when enough data is collected. When **<Auto STOP: Yes>** in **CONFIGURE Point Occupation Settings**, logging of static observations ends automatically as defined by the stop criteria. The position mode icon changes to the moving icon. (F1) changes to **STORE**.

STORE (F1)

To store the measured point. When **<Auto STORE: Yes>** in **CONFIGURE Point Occupation Settings**, the measured point is stored automatically. **(F1)** changes to **OCUPY**.

It may happen that a point with the same point ID exists in the job. If the codes and/or attribute values of the new and the existing point do not match, a screen opens where they can be corrected. Refer to "11.6 Code and Attribute Mismatch".

NEAR (F2)

To compare the user's current position with the coordinates of all points already stored in the job and find the nearest point. This point ID is then suggested as the next point ID to be used.

H PNT(F5)

To measure a hidden point. Refer to "46 Survey - Hidden Points".

PAGE (F6)

To change to another page on this screen.

SHIFT CONF (F2)

To configure auto points and hidden point measurements. Accesses **SURVEY Configuration**. Refer to "45 Survey - Auto Points". Refer to "46 Survey - Hidden Points" for information on the fields and keys.

SHIFT INDIV (F5) and SHIFT RUN (F5)

To change between entering an individual point ID different to the defined ID template and the running point ID according to the ID template. Refer to "19.1 ID Templates".

Description of fields

Field	Option	Description
<Point ID:>	User input	The identifier for manually occupied points. The configured point ID template is used. The ID can be changed in the following ways: <ul style="list-style-type: none">• To start a new sequence of point ID's type over the point ID.• For an individual point ID independent of the ID template SHIFT INDIV (F5). SHIFT RUN (F5) changes back to the next ID from the configured ID template. Refer to "19.1 ID Templates".
<Antenna Ht:>	User input	The default antenna height as defined in the active configuration set is suggested. Refer to "2 Antenna Heights". Changing the antenna height here does not update the default antenna height as defined in the active configuration set. The changed antenna height is used until the application program is exited.
<3D CQ:>	Output	The current 3D coordinate quality of the computed position.

Next step

PAGE (F6) changes to another page on this screen.

44.3.2

Real-Time Reference Operations

Description

Refer to "44.2 GPS Surveying Techniques" for information on the real-time reference surveying technique.

Requirements

- A typical configuration set for real-time reference operations is used.
- A real-time interface is configured correctly.
- The real-time device is attached to the receiver and working properly.



















Access step-by-step

Step	Description
1.	Refer to "44.1 Accessing Survey" to access SURVEY Survey Begin .
2.	In SURVEY Survey Begin select a job.
3.	Select a typical configuration set with <R-Time Mode: Reference> .
4.	Select an antenna.
5.	CONT (F1) to access SURVEY Set Up Reference Station .
	The position mode icon is the moving icon. This indicates that the antenna can be moved around and that no static observations are being recorded.

SURVEY

Set Up Reference Station

The settings on this screen set the reference station and its coordinates.

12:15	      			
SURVEY	      			
Set Up Reference Station 				
Point ID	:		100	 
Antenna Ht	:		1.3820	m
WGS84 Lat	:	47°24'32.30278"	N	
WGS84 Long	:	9°37'03.07537"	E	
WGS84 Ell Ht	:	488.1214	m	
Q1 a 				
CONT	COORD		HERE	

CONT (F1)

To accept changes and access the subsequent screen. The chosen settings become active.

COORD (F2)

To view other coordinate types. Local coordinates are available when a local coordinate system is active.

LAST (F3)

To use the same coordinates as when the receiver was last used as reference station. Available when the receiver has previously been used as reference station and if no point in the active job has the same point ID as the one last used as reference station.

Refer to paragraph "Set the reference station coordinates step-by-step".

HERE (F4)

To use the coordinates of the current navigation position as reference station coordinates. Refer to paragraph "Set the reference station coordinates step-by-step".

SHIFT ELL H (F2) and SHIFT ORTH (F2)

To change between the ellipsoidal and the orthometric height. Available for local coordinates.

Description of fields

Field	Option	Description
<Point ID:>	Choicelist	The point selected as reference station. Opening the choicelist opens SURVEY Data: Job Name which is similar to MANAGE Data: Job Name . Refer to "9.2 Accessing Data Management".
<Antenna Ht:>	User input	The default antenna height as defined in the active configuration set is suggested. Refer to "2 Antenna Heights". Changing the antenna height here does not update the default antenna height as defined in the active configuration set. The changed antenna height is used until the application program is exited.

Next step

The reference station coordinates can be entered in three different ways.



IF the coordinates of the reference station	THEN
are known	Refer to paragraph "Set the reference station coordinates step-by-step", "Using a known point stored in the active job".
are those from the last used reference station	Refer to paragraph "Set the reference station coordinates step-by-step", "Using the coordinates from the last used reference station".

IF the coordinates of the reference station	THEN
are those of the current navigation position	Refer to paragraph "Set the reference station coordinates step-by-step", "Using the coordinates of the current navigation position".

Set the reference station coordinates step-by-step



Using a known point stored in the active job

The following table explains the most common settings. Refer to the stated chapter for more information on screens.

Step	Description	Refer to chapter
1.	Refer to paragraph "Access step-by-step" to access SURVEY Set Up Reference Station .	
2.	<p>SURVEY Set Up Reference Station</p> <p>Select the point to be used as reference station.</p> <p> A point may already be stored in the active job either by manual entry, by measuring or by transfer from LGO.</p> <p> If a new point is to be created, open the choicelist for <Point ID:> and NEW (F2).</p> <p> If an existing point is to be edited, open the choicelist for <Point ID:> and EDIT (F3).</p>	
3.	Check the antenna height.	



Step	Description	Refer to chapter
4.	CONT (F1) to access SURVEY Survey: Job Name .	SURVEY Survey: Job Name.

Using the coordinates from the last used reference station



Step	Description	Refer to chapter
	The receiver must have previously been used as reference station. After turning off, the reference station coordinates are stored in the System RAM. They can be used again the next time the receiver is used as a reference station. This means that even if the Compact-Flash card that previously contained the reference station coordinates is formatted, the last used coordinates can still be used.	
1.	Refer to paragraph "Access step-by-step" to access SURVEY Set Up Reference Station .	
2.	LAST (F3)	
	The point ID and coordinates of the last used reference station are displayed in grid. When no local coordinate system is active, WGS 1984 coordinates are displayed.	
3.	Check the antenna height.	

Step	Description	Refer to chapter
4.	CONT (F1) to access SURVEY Survey: Job Name.	SURVEY Survey: Job Name.

Using the coordinates of the current navigation position

Step	Description	Refer to chapter
1.	Refer to paragraph "Access step-by-step" to access SURVEY Set Up Reference Station.	
2.	HERE (F4) to access SURVEY New Reference Point.	
3.	SURVEY New Reference Point, Coords page The current navigation position in grid is displayed. When no local coordinate system is active, WGS 1984 coordinates are displayed. Type in a point ID for this new point.	
	COORD (F2) views other coordinate types. Local coordinates are available when a local coordinate system is active.	
	SHIFT ELL H (F2) and SHIFT ORTH (F2) . Available for local geodetic coordinates. Changes between the ellipsoidal and the orthometric height.	
4.	PAGE (F6) changes to the Code page.	
5.	SURVEY New Reference Point, Code page	19.3

Step	Description	Refer to chapter
	<p>The setting for <Themac Codes:> in CONFIGURE Coding & Linework determines the availability of the subsequent fields and softkeys.</p> <ul style="list-style-type: none"> For <Themac Codes: With Codelist>: The codes from the job codelist are used. <Code:> Codes from the job codelist can be selected. The setting for <Show Codes:> in CONFIGURE Coding & Linework determines if either all codes or only point codes are available. The description of the code is shown as an output field. The attributes are shown as output, input or choicelist fields depending on their definition. For <Themac Codes: Without Codelist>: Codes for points can be typed in but not selected from a codelist. <Code:> The point code to be stored with the point. A check is performed to see if a point code of this name already exists in the job. If so, the according attributes are shown. <Attribute n:> Up to eight attribute values are available. 	
6.	<p>Is <Themac Codes: With Codelist>?</p> <ul style="list-style-type: none"> If yes, continue with the next row. If no, continue with step 7. 	
	<p>NEW-A (F2) allows additional attributes to be created for this point code.</p>	

Step	Description	Refer to chapter
	LAST (F4) recalls the last used attribute values which were stored with this point code.	
	DEFLT (F5) recalls the default attribute values for the selected code.	
7.	<p>STORE (F1) stores the new point and all associated information and returns to SURVEY Set Up Reference Station.</p> <p>The properties stored with the point are:</p> <p>Class: NAV</p> <p>Sub class: GPS Code Only</p> <p>Source: Survey (Static)</p> <ul style="list-style-type: none"> • Instrument source: GPS 	
8.	<p>SURVEY Set Up Reference Station</p> <p>The coordinates of the new point are displayed.</p> <p>Check the antenna height.</p>	
9.	CONT (F1) to access SURVEY Survey: Job Name .	SURVEY Survey: Job Name.

SURVEY
Survey: Job Name

The appearance and functionality of the screen is identical for all real-time reference configuration sets. Display masks cannot be used for real-time reference configuration sets.

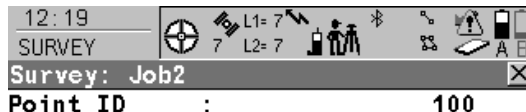

Point ID : 100

Antenna Ht : 1.3820 m

Time at Point: 00:02:01

GDOP : 2.2

Q1 a ↑

STOP

STOP (F1)
 To end the point occupation, store the point and to return to **GPS1200 Main Menu**.

Description of fields

Field	Option	Description
<Point ID:>	Output	The identifier for the reference station point.
<Antenna Ht:>	Output	The antenna height as entered in SURVEY Set Up Reference Station is displayed. Refer to "2 Antenna Heights".
<Time at Point:>	Output	The time from when the point is occupied until point occupation is stopped.
<GDOP:>	Output	The current GDOP of the computed position.

Next step

STOP (F1) to end the point occupation, store the point and to return to **GPS1200 Main Menu**.

44.3.3

Real-Time Rover Operations

Description



Refer to "44.2 GPS Surveying Techniques" for information on the real-time rover surveying technique.

Requirements

- A typical configuration set for real-time rover operations is used.
- A real-time interface is configured correctly.
- The according real-time device is attached and working properly.

Access step-by-step

The table describes the main access to **SURVEY Survey: Job Name**. Access is possible from other screens where individual point measurements are needed, for example from **COGO Inverse** with **SURVY (F5)**.

Step	Description
1.	Refer to "44.1 Accessing Survey" to access SURVEY Survey Begin .
2.	In SURVEY Survey Begin select a job.
3.	Select a typical configuration set with <R-Time Mode: Rover> .
4.	Select an antenna.
5.	CONT (F1) to access SURVEY Survey: Job Name .
	The arrow at the real-time device and real-time status icon flashes when real-time messages are being received.
	Fixing ambiguity begins. The current position status is indicated by the position status icon. When working with code only corrections, an ambiguity solution is not attempted.
	The position mode icon is the moving icon. This indicates that the antenna can be moved around and that no static observations are being recorded.

SURVEY**Survey: Job Name,
Survey page**

The fields shown are those from a typical configuration set for real-time rover operations. The screen described consists of the **Survey** page and the **Map** page. The explanations for the softkeys given below are valid for the **Survey** page. Refer to "32 MapView Interactive Display Feature" for information on the keys on the **Map** page. The fields and functionality of this screen vary slightly when accessed from other application programs where individual point measurements are needed.

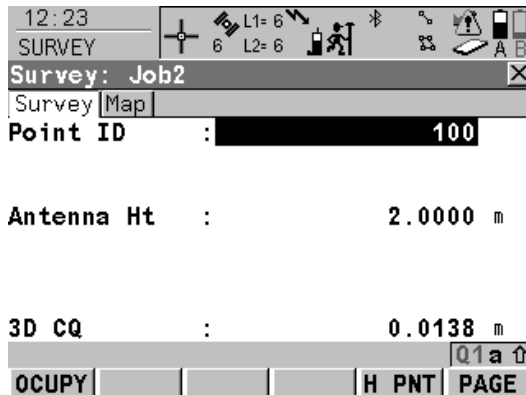
**OCUPY (F1)**

To start recording positions. The position mode icon changes to the static icon. **(F1)** changes to **STOP**.

STOP (F1)

To end recording of positions when enough data is collected. When **<Auto STOP: Yes>** in **CONFIGURE Point Occupation Settings**, recording of positions ends automatically as defined by the stop criteria. The position mode icon changes to the moving icon. **(F1)** changes to **STORE**.

STORE (F1)

To store the point information. When **<Auto STORE: Yes>** in **CONFIGURE Point Occupation Settings**, the measured point is stored automatically. **(F1)** changes to **OCUPY**.

It may happen that a point with the same point ID exists in the job. If the codes and/or attribute values of the new and the existing point do not match, a screen opens where they can be corrected. Refer to "11.6 Code and Attribute Mismatch".

H PNT(F5)

To measure a hidden point. Refer to "46 Survey - Hidden Points".

PAGE (F6)

To change to another page on this screen.

SHIFT CONF (F2)

To configure auto points and hidden point measurements. Accesses **SURVEY Configuration**. Refer to "45 Survey - Auto Points". Refer to "46 Survey - Hidden Points" for information on the fields and keys.

SHIFT AVGE (F2)

To check the residuals for the averaged position. Available for **<Averaging Mode: Average>** and for more than one measured coordinate triplet recorded for the same point. Refer to "9.3.4 Mean Page".

SHIFT ABS (F2)

To check the absolute difference between measurements. Available for **<Averaging Mode: Absolute Diffs>** and for more than one measured coordinate triplet recorded for the same point. Refer to "9.3.4 Mean Page".

SHIFT CONEC (F3) and SHIFT DISCO (F3)

To dial the number of the reference station configured in the active configuration set and to hang up immediately after the survey is completed. Available for real-time devices of type digital cellular phone or modem. Available for **<Auto CONEC: No>** in **CONFIGURE GSM Connection**.

SHIFT INIT (F4)

To select an initialisation method and to force a new initialisation. Available for configuration sets allowing phase fixed solutions. Refer to "44.6 Initialisation for Real-Time Rover Operations".

SHIFT INDIV (F5) and SHIFT RUN (F5)

To change between entering an individual point ID different to the defined ID template and the running point ID according to the ID template. Refer to "19.1 ID Templates".

Description of fields

Field	Option	Description
<Point ID:>	User input	The identifier for manually occupied points. The configured point ID template is used. The ID can be changed in the following ways: <ul style="list-style-type: none">• To start a new sequence of point ID's type over the point ID.• For an individual point ID independent of the ID template SHIFT INDIV (F5). SHIFT RUN (F5) changes back to the next ID from the configured ID template. Refer to "19.1 ID Templates".
<Antenna Ht:>	User input	The default antenna height as defined in the active configuration set is suggested. Refer to "2 Antenna Heights". Changing the antenna height here does not update the default antenna height as defined in the active configuration set. The changed antenna height is used until the application program is exited.
<3D CQ:>	Output	The current 3D coordinate quality of the computed position.

Next step

PAGE (F6) changes to another page on this screen.

44.4

Adding Annotations for All Types of Operations





Description

Annotations can be used to add either field notes or comments to points being surveyed. They can be added to points for all types of GPS operations and are imported into LGO.

Access

Refer to "44.1 Accessing Survey" to access **SURVEY Survey Begin**.

Add annotations step-by-step

Step	Description
	A display mask for a page with input fields for annotations must be configured. In this example, it is called Annot page.
1.	In SURVEY Survey Begin select a job, a configuration set, an antenna and a codelist, if configured.
2.	CONT (F1) to access SURVEY Survey: Job Name .
3.	PAGE (F6) until the Annot page is active.
4.	Highlight <A1:> .
5.	Type in the annotation. The annotation may be up to 16 characters long and may include spaces.
	When the ASCII input interface is configured to be used and an annotation is reserved for the incoming ASCII string, then no other information can be typed in for the particular annotation.
	CE to clear the entry.
	LAST (F4) to recall all annotations entered for the previously surveyed point. Any annotations just entered are overwritten.
6.	ENTER . The next line is highlighted.

Step	Description
7.	Are more annotations to be typed in? <ul style="list-style-type: none">• If yes, repeat steps 5. to 7.• If no, continue with step 8.
	When the seismic record is configured to be used, <A4: Seismic Record> cannot be changed.
8.	OCUPY (F1) to start the point occupation.
9.	STOP (F1) to end the point occupation.
10.	STORE (F1) to store the point information including the annotations.

44.5

Timed Occupations for All Types of Operations

Description

Surveying regulations in some countries require that several receivers in a session start the point occupation simultaneously at a predefined time. A start time can be specified in **SURVEY Survey: Job Name**, **Survey** page. Timed occupations are possible for all types of GPS operations, except for real-time reference operations.

Requirements

- **<Auto OCCUPY: Timed>** is configured in **CONFIGURE Point Occupation Settings**. Refer to "19.6 Point Occupation Settings".
- **Time at Point** is configured for one of the lines in one of the display masks. Refer to "19.2 Display Settings".









Access step-by-step



The functionality for timed occupations is integrated in **SURVEY Survey: Job Name**. The table describes the main access to **SURVEY Survey: Job Name**. Access is possible from other screens where individual point measurements are needed, for example from **COGO Inverse** with **SURVY (F5)**.

Step	Description
1.	Refer to "44.1 Accessing Survey" to access SURVEY Survey Begin .
2.	In SURVEY Survey Begin select a job.
3.	Select a configuration set.
4.	Select an antenna.
5.	CONT (F1) to access SURVEY Survey: Job Name .

Timed occupation step-by-step

The table describes one special part of the GPS operation for individual GPS surveying techniques. Refer to "44.3 Surveying Points" for information on performing the individual operations.

Step	Description	Refer to chapter
1.	Refer to paragraph "Access step-by-step" to access SURVEY Survey: Job Name .	
2.	PAGE (F6) until the page displaying <Start Time:> is active.	
	<Start Time:> The current local time with the seconds rounded to 00, for example for the current local time 07:37:12 it is <Start Time: 07:38:00> .	
3.	Highlight <Start Time:> .	
4.	Type in the start time in hours, minutes and seconds when the point occupation should begin.	
5.	OCUPY (F1)	
	The point occupation does not start yet. This is indicated by the position mode icon.	
	<Start Time:> changes to <Time to Go:> .	
	<Time to Go:> The countdown time in hours, minutes and seconds before the point occupation starts automatically.	
	The point occupation starts when <Time to Go: 00:00:00> .	
	Data is logged as configured in the configuration set. This is indicated by the position mode icon.	
	Any occupation counter defined to be used in display mask is displayed and starts incrementing.	
	<Time to Go:> changes to <Time at Point:> .	

Step	Description	Refer to chapter
	<Time at Point:> The time in hours, minutes and seconds from when the point is occupied until point occupation is stopped.	
6.	When <Auto STOP: No> in CONFIGURE Point Occupation Settings, STOP (F1) when enough data is collected.	19.6
7.	When <Auto STORE: No> in CONFIGURE Point Occupation Settings, STORE (F1) to store the point information.	19.6
	<Time at Point:> changes to <Start Time:> displaying the current local time with the seconds rounded to 00.	
8.	Are more points to be surveyed? <ul style="list-style-type: none"> • If yes, continue with step 9. • If no, continue with step 11. 	
9.	Move to the next point.	
10.	Repeat steps 3. to 8.	
11.	SHIFT QUIT (F6) to return to from where SURVEY Survey: Job Name was accessed.	

44.6

44.6.1

Initialisation for Real-Time Rover Operations

Terminology

Description

This chapter describes technical terms related to initialisation.

Initialisation

For cm positioning with GPS, the ambiguities need to be fixed. The process of fixing ambiguities is called initialisation. In order to carry out an initialisation, the active configuration set must be a real-time rover configuration allowing for phase fixed solutions. A minimum of five satellites on L1 and L2 is required.

The three existing types of initialisation methods are:

- Moving
- Static
- On a known point

Description of initialisation methods

Initialisation method	Characteristic	Description
Moving	Principle	The rover receiver is moved from the beginning of the GPS operation on, recording data. The trajectory of the moving rover is recorded. Ambiguities are fixed while moving. A new initialisation starts automatically when, after losing the minimum number of required satellites, enough satellites are tracked again.
	Antenna setup	On a pole.

Initialisation method	Characteristic	Description
	Beginning of initialisation Use	Immediately. For fast initialisations over distances up to 30 km.
Static	Principle Antenna setup Beginning of initialisation Use	The rover receiver is kept stationary at the beginning of the GPS operation. On a pole with a quickstand. Immediately. If it is proving difficult to initialise while moving and no known point is available.
Known point	Principle Antenna setup Beginning of initialisation Use	The rover receiver is kept stationary over a point with known coordinates at the beginning of the GPS operation. On a pole with a quickstand. After selecting the known point. If it is proving difficult to initialise while moving and to speed up an initialisation while static.

44.6.2

Accessing Initialisation for Real-Time Rover Operations

Requirements

- The active configuration set is a real-time rover configuration.
- The configured real-time data format in **CONFIGURE Real-Time Mode** is other than **<R-Time Data: RTCM 1,2 v2>** and **<R-Time Data: RTCM 9,2 v2>**.

Access step-by-step

The table describes the main access to **SURVEY Survey: Job Name**. Access is possible from other screens where individual point measurements are needed, for example from **COGO Inverse** with **SURVY (F5)**.





Step	Description	Refer to chapter
1.	Refer to "44.1 Accessing Survey" to access SURVEY Survey Begin .	
2.	In SURVEY Survey Begin select a job.	
3.	Select a configuration set with the configured real-time data format other than <R-Time Data: RTCM 1,2 v2> and <R-Time Data: RTCM 9,2 v2> .	
4.	Select an antenna.	
5.	CONT (F1) to access SURVEY Survey: Job Name .	
6.	SHIFT INIT (F4) to access SURVEY Initialisation .	
7.	Highlight the required initialisation method.	
	For Initialise while Static and Initialise on Known Point , the antenna setup must be static on a pillar, a tripod or on a pole with a quickstand.	

Step	Description	Refer to chapter
	For Initialise on Known Point , the coordinates of the point must be known in the WGS 1984. They must be stored in the active job either by manual entry or by measuring.	9.2
8.	CONT (F1)	
9.	Is Initialise while Moving selected? Is Initialise while Static selected? Is Initialise on Known Point selected?	44.6.3 44.6.3 44.6.5

44.6.3

Initialise while Moving





Initialise while moving step-by-step

Step	Description
1.	Refer to "44.6.2 Accessing Initialisation for Real-Time Rover Operations" to access the initialisation.
2.	Does the receiver currently have a fixed solution? <ul style="list-style-type: none">• If yes, continue with step 4.• If no, continue with the next row.
	The initialisation starts automatically.
3.	Continue with the row after step 4.
4.	YES (F6) to start the initialisation. The current ambiguity solution is discarded.
	SURVEY Survey: Job Name
	The position status icon changes to the code solution icon.
	OCUPY (F1) is available but must not be pressed until the ambiguity solution is gained.
5.	The initialisation is gained when the ambiguities are solved. This is indicated by the position status icon.
6.	Continue with the surveying operation.

44.6.4

Initialise while Static

Initialise while static
step-by-step

Step	Description	Refer to chapter
1.	Refer to "44.6.2 Accessing Initialisation for Real-Time Rover Operations" to access the initialisation.	
2.	Does the receiver currently have a fixed solution? <ul style="list-style-type: none"> • If yes, continue with step 4. • If no, continue with the next row. 	
	The initialisation starts automatically.	
3.	Continue with step 7.	
4.	YES (F6) to start the initialisation. The current ambiguity solution is discarded.	
	SURVEY Survey: Job Name	
	The position status icon changes to the code solution icon.	
	STOP (F1) is available but must not be pressed until the ambiguity solution is gained.	
	The initialisation is gained when the ambiguities are solved. This is indicated by the position status icon.	
5.	Any configurations for <Auto STOP:> in CONFIGURE Point Occupation Settings are ignored. STOP (F1) when enough data is collected.	19.6







Step	Description	Refer to chapter
6.	When <Auto STORE: No> in CONFIGURE Point Occupation Settings, STORE (F1) to store the point information.	19.6
7.	Continue with the surveying operation.	

44.6.5

Initialise on Known Point

Initialise on known point step-by-step

Step	Description	Refer to chapter
1.	Refer to "44.6.2 Accessing Initialisation for Real-Time Rover Operations" to access the initialisation.	
2.	Does the receiver currently have a fixed solution? <ul style="list-style-type: none"> • If yes, continue with step 3. • If no, continue with step 4. 	
3.	YES (F6) to start the initialisation. The current ambiguity solution is discarded.	
4.	SURVEY Data: Job Name This screen is similar to MANAGE Data: Job Name . Highlight the known point for the initialisation.	9.2
5.	CONT (F1) starts the initialisation.	
	SURVEY Survey: Job Name <Point ID:> The ID of the selected known point is displayed. <Antenna Ht:> The default antenna height as defined in the active configuration set is suggested. Changing the antenna height here does not update the default antenna height as defined in the active configuration set. The changed antenna height is used until the application program is exited. Enter the correct antenna height.	

Step	Description	Refer to chapter
	If required, add a code.	11
	If required, add an annotation.	44.4
	The position status icon changes to the code solution icon.	
	STOP (F1) is available but must not be pressed until the ambiguity solution is gained.	
	The initialisation is gained when the ambiguities are solved. This is indicated by the position status icon.	
6.	Any configurations for <Auto STOP:> in CONFIGURE Point Occupation Settings are ignored. When the initialisation is gained, the recording of positions stops automatically.	19.6
7.	When <Auto STORE: No> in CONFIGURE Point Occupation Settings , STORE (F1) to store the point information.	19.6
	An average is automatically calculated with the known coordinates.	
8.	Continue with the surveying operation.	

45

Survey - Auto Points

45.1

Overview

Description

Auto points is used to automatically log points at a specific rate. Additionally, individual auto points can be stored outside the defined rate. Auto points are used in real-time or post-processed moving applications to document the track which was walked or driven along. Auto points are logged between starting and stopping logging of auto points form one chain. A new chain is formed each time logging of auto points is started.

Auto points can be collected in the Survey application program. An **Auto** page is visible when logging of auto points is active.

Up to two offset points related to one auto point can be logged. The offset points can be both to the left or right and they can be coded independently of each other and of the auto points. Refer to "45.4 Offset Points of Auto Points".



Coding of auto points

Logging of auto points is possible for **<R-Time Mode: Rover>** and **<R-Time Mode: None>**.

Coding of auto points is similar to coding manually occupied points. Refer to "11 Coding" for information on coding.

The differences are:

- Thematical coding: Available for **<Store: DBX(Pts&Codes)>** in **SURVEY Configuration, Auto Points** page.
- Free coding: Always available.
- Quick coding: Not available.
- Codes of auto points overwrite the codes of points existing in the active job with the same point ID but with a different code as the auto point.

- Codes of auto points can be changed when no auto points are being logged.
 - Up to three attributes can be stored with a code.
-

Properties of auto points

The properties stored with auto points are:

- Class: Either **MEAS** or **NAV** depending on the class of the manually occupied points.
 - Sub class: **GPS Fixed** or **GPS Code Only**
 - Source: **Survey (Auto)** or **Survey (Auto Of)**
 - Instrument source: **GPS**
-

Averaging of auto points

An average is never calculated for auto points even if a manually occupied point of class **MEAS** already exists with the same point ID.

45.2

Configuring Auto Points

Access

Select **Main Menu: Survey**. In **SURVEY Survey Begin** press **CONF (F2)** to access **SURVEY Configuration**.

OR

In **SURVEY Survey: Job Name** press **SHIFT CONF (F2)** to access **SURVEY Configuration**.

**SURVEY
Configuration,
Auto Points page**

The settings on this page activate the logging of auto points and define the method of logging.

23:52
SURVEY

Configuration

SCode	Auto Points	Hidden Points
Log Auto Pts :	Yes	
Log By :	Time	
Log Every :	1.0s	
Store :	DBX(Pts&Codes)	
Start Logging:	Controlled	
Monitor CQ :	Yes	
3D CQ Limit :	0.500 m	

Q1 a ↑

CONT DMASK PAGE

CONT (F1)

To accept changes and return to the screen from where this screen was accessed.

DMASK (F3)

To configure what is viewed in the **Auto** page in the Survey application program. Available for <Log Auto Pts: Yes>. Refer to paragraph "SURVEY Configure Auto Pts Display Mask" below.

PAGE (F6)

To change to another page on this screen.

Description of fields

Field	Option	Description
<Log Auto Pts:>	Yes	Activates the logging of auto points.  All other fields on the screen are active and can be edited.
	No	Deactivates logging of auto points and all fields on this screen.
<Log By:>	Time	Auto points are logged according to a time interval. The time interval is independent from the update interval for the position on the screen.
	Distance	The difference in distance from the last stored auto point, which must be reached before the next auto point is logged. The auto point is logged with the next available computed position.
	Height Diff	The height difference from the last stored auto point, which must be reached before the next auto point is logged. The auto point is logged with the next available computed position.
	Dist or Ht	Before the next auto point is logged, either the difference in distance or the difference in height must be reached. The auto point is logged with the next available computed position.

Field	Option	Description
	<p>Stop & Go</p> <p>User Decides</p>	<p>An auto point is stored when the position of the antenna does not move more than the distance configured in <Stop Position:> within the <Stop Time:>.</p> <p>Once a point has been stored, the position from the point just stored must change more than the distance configured in <Stop Position:> before the routine starts again.</p> <p>An auto point is stored upon pressing OCUPY (F3) in SURVEY Survey: Job Name, Auto page. In the beginning, the chain to which the auto points should be assigned must be started with START (F1). In the end, the chain must be closed with STOP (F1).</p>
<Log Every:>	<p>User input</p> <p>For <Log By: Time> from 0.05s to 60.0s</p>	<p>Available unless <Log By: Dist or Ht>.</p> <p>For <Log By: Distance> and <Log By: Height Diff>. The difference in distance or height before the next auto point is logged.</p> <p>For <Log By: Time>. The time interval before the next auto point is logged.</p>
<Min Distance:>	User input	Available for <Log By: Dist or Ht> . The value for the difference in distance before the next auto point is logged.

Field	Option	Description
<Min Height:>	User input	Available for <Log By: Dist or Ht>. The value for the height difference before the next auto point is logged.
<Stop Position:>	User input	Available for <Log By: Stop & Go>. The maximum distance within which the position is considered stationary.
<Stop Time:>	User input	Available for <Log By: Stop & Go>. The time while the position must be stationary until an auto point is stored.
<Store:>	<p>File (Pts Only)</p> <p>DBX(Pnts& Codes)</p>	<p> Changing this setting while auto points are being logged stops the logging. It must then be restarted.</p> <p>Logs auto point to a measurement file. Point logging at up to 20 Hz. Coding and logging of offset points is not possible. Points cannot be displayed in MapView or output via format files.</p> <p>Logs auto points to the DB-X. Point logging at up to 1 Hz. Coding and logging of offset points is possible. Points can be displayed in MapView or output via format files.</p>
<Start Logging:>	<p>Immediately</p> <p>Controlled</p>	<p>Logging of auto points starts immediately when the SURVEY screen is accessed.</p> <p>Logging of auto points starts upon pressing START (F1) on the Auto page in SURVEY.</p>

Field	Option	Description
<Monitor CQ:>	Yes or No	Activates monitoring of the coordinate quality. Auto points are stored when the coordinate quality is within the defined limit. For example, only phase fixed solutions can be logged by defining a CQ limit.
<3D CQ Limit:>	User input	Available for <Monitor CQ: Yes>. Limit for the coordinate quality above which an auto point is no longer automatically stored. When the CQ of the auto point falls again below the defined value then the storing of auto points begins again.
<Beep When:>	Logging Not Logging Never	Instrument beeps when storing an auto point. Available for <Monitor CQ: Yes>. Instrument gives a single alarm beep each time an auto point is not recorded because the limit for the coordinate quality is exceeded. For <Log By: Time> the beep is given at the time when the point should have been recorded. Unless <Log By: Time>, the beep is given at 1 Hz once the auto logging has stopped due to the exceeded coordinate quality. Instrument never beeps.

Next step

IF the display mask	THEN
is not to be configured	CONT (F1) closes the screen and returns to the screen from where SURVEY Configuration, Auto Points page was accessed.
is to be configured	DMASK (F3) . Refer to paragraph "SURVEY Configure Auto Pts Display Mask".

SURVEY Configure Auto Pts Display Mask

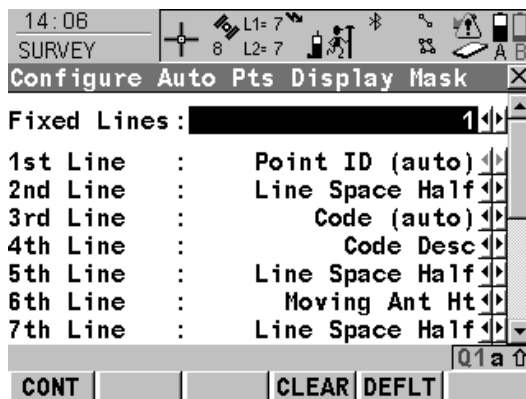

CONT (F1)

To accept changes and return to the screen from where this screen was accessed.

CLEAR (F4)

To set all fields to <XX. Line: Line Space Full>.

DEFLT (F5)

To recall the default settings. Available if the active configuration set is a default configuration set.

Description of fields

Field	Option	Description
<Fixed Lines:>	From 0 to 5	Defines how many lines do not scroll in SURVEY Survey: Job Name, Auto page when that display mask is used.

Field	Option	Description
<1st Line:>	Output	Fixed to <1st Line: Point ID (auto)>.
<2nd Line:> to <16th Line:>	Annot 1-4 Attrib (free) 01-20 Attrib 01-03 Code (auto) Code (free) Code Desc Code Desc (free) Code Type GDOP HDOP Line Space Full Line Space Half Linework Moving Ant Ht	Input field for comments to be stored with the point. Output field for attributes for free codes. Input field for attributes for codes. Choicelist or input field for codes. Output field for free codes. Output field for the description of codes. Output field for the description of free codes. Output field for the type of code, for example point code, line code or area code. Output field for the current GDOP of the computed position. Output field for the current HDOP of the computed position. Insert full line space. Insert half line space. Choicelist with instructions how the software should flag a line/area. Refer to "12 Linework". Input field for antenna height for the auto point. This is the same as the antenna height for moving observations.

Field	Option	Description
	Msd Auto Points	Output field for the number of auto points logged after pressing START (F1) in SURVEY Survey: Job Name, Auto page. Counting starts again from 0 when START (F1) is pressed again.
	PDOP	Output field for the current PDOP of the computed position.
	Quality 1D	Output field for the current height quality of computed position.
	Quality 2D	Output field for the current 2D quality of computed position.
	Quality 3D	Output field for the current 3D quality of computed position.
	VDOP	Output field for the current VDOP of the computed position.

Next steps

Step	Description
1.	CONT (F1) closes the screen and returns to SURVEY Configuration, Auto Points page.
2.	CONT (F1) returns to the screen from where SURVEY Configuration, Auto Points page was accessed.

45.3

Auto Points for Post-Processed Kinematic and Real-Time Rover Operations

Requirements

- <R-Time Mode: None> or <R-Time Mode: Rover> in **CONFIGURE Real-Time Mode**.
- <Log Auto Pts: Yes> in **SURVEY Configuration, Auto Points** page.

Access step-by-step

Step	Description
1.	Refer to "44.1 Accessing Survey" to access SURVEY Survey Begin .
2.	In SURVEY Survey Begin select a job.
3.	Select a configuration set with <R-Time Mode: None> or <R-Time Mode: Rover>.
4.	Select an antenna.
5.	CONT (F1) to access SURVEY Survey: Job Name .
	For <Start Logging: Immediately>, logging of auto points begins.
6.	PAGE (F6) until the Auto page is visible.

SURVEY

Survey: Job Name,
Auto page

The **Auto** page of a typical configuration set is explained. Before logging of auto points has started, the page appears as shown below:

09:41
SURVEY
Survey: Default
Survey Code Auto Map
Auto Pt ID : Time & Date
Code (Auto) : Road
Code Desc : Edge of Road
Moving Ant Ht: 2.000 m
Msd Auto Pts : 12
3D CQ : 0.017 m
Q1 a
STOP OCUPY OFST1 OFST2 PAGE

START (F1)

To start logging of auto points and offset points if configured or, for **<Log By: User Decides>**, to start the chain to which the auto points should be assigned. The first auto point is stored.

For **<Start Logging: Immediately>** in **SURVEY Configuration, Auto Points** page, logging of auto points starts immediately when the **SURVEY** screen is accessed and **START (F1)** need not be pressed.

STOP (F1)

To end recording of auto points and offset points if configured or, for **<Log By: User Decides>**, to end the chain to which the auto points are assigned.

OCUPY (F3)

Available for **STOP (F1)**. To store an auto point at any time.

OFST1 (F4)

To configure recording of the first type of offset points. Available for **<Store: DBX(Pts&Codes)>** in **SURVEY Configuration, Auto Points** page. Refer to "45.4 Offset Points of Auto Points".

OFST2 (F5)

To configure recording of a second type of offset points. Available for **<Store: DBX(Pts&Codes)>** in **SURVEY Configuration, Auto Points** page. Refer to "45.4 Offset Points of Auto Points".

PAGE (F6)

To change to another page on this screen.

SHIFT CONF (F2)

To configure auto points. Refer to "45.2 Configuring Auto Points".

SHIFT QUIT (F6)

To exit the Survey application program. Point information logged until pressing **SHIFT QUIT (F6)** is saved in the database.

Description of fields

Field	Option	Description
<Auto Pt ID:>	User input	Available unless <Auto Pts: Time & Date> in CONFIGURE ID Templates . The identifier for auto points. The configured ID template for auto points is used. The ID can be changed. To start a new sequence of point ID's type over the point ID.
	Time & Date	Available for <Auto Pts: Time & Date> in CONFIGURE ID Templates . The current local time and date is used as identifier for auto points.

Field	Option	Description
<Code (Auto):>		<p>The thematical code for the auto point.</p>  <ul style="list-style-type: none"> • If a point code is selected then any open line/area is closed. The occupied point is stored with the selected code independently of any line/area. • If a line code is selected then any open line is closed and a new line with the selected code is created. The line ID is defined by the configured line ID template. The occupied point is assigned to that line. The line stays open until it is closed manually or another line code is selected. • If an area code is selected then the behaviour is as for lines.
	Choicelist	<p>Available for <Themac Codes: With Codelist>. The setting for <Show Codes:> in CONFIGURE Coding & Linework determines if either all codes or only point codes are available. The attributes are shown as output, input or choicelist fields depending on their definition.</p>
	User input	<p>Available for <Themac Codes: Without Codelist>. Codes can be typed in but not selected from a codelist. A check is performed to see if a code of this name already exists in the job. If so, the according attributes are shown. Configure a display mask with a choicelist for code types to define if a point, line or area code is typed in.</p>

Field	Option	Description
<Code Desc:>	Output	The description of the code.
<Moving Ant Ht:>	User input	The default antenna height for auto points as defined in the active configuration set is suggested. Refer to "2 Antenna Heights".
<Msd Auto Pts:>	Output	Available after pressing START (F1) . The number of auto points logged since START (F1) has been pressed.
<3D CQ:>	Output	The current 3D coordinate quality of the computed position.

Next step

IF	THEN
auto points are to be logged	START (F1) . Then, for <Log By: User Decides>, OCUPY (F3) whenever an auto point is to be logged.
offset points are to be configured	OFST1 (F4) or OFST2 (F5) . Refer to "45.4 Offset Points of Auto Points".

45.4

45.4.1

Offset Points of Auto Points

Overview

Description

Offset points

- can be created with auto points when auto points are stored to the DB-X.
- can be to the left or to the right of auto points.
- are automatically computed with the logging of auto points, if configured.
- form a chain relative to the chain of auto points to which they are related. Subsequently computed chains are independent from each other.
- can be coded independently of auto points.
- have the same time of when they were stored as the auto points to which they are related.
- have the same coding functionality, properties and averaging functionality as auto points. Refer to "45.1 Overview".

Up to two offset points can be related to one auto point.

The screens for the configuration of offset points are identical except for the title **Auto Points - Offset 1** and **Auto Points - Offset 2**. For simplicity, the title **Auto Points - Offset** is used in the following description.

Computation of offset points

The computation of offset points depends on the number of auto points in one chain.

One auto point

No offset points are computed or stored.

Two auto points

The configured offsets are applied perpendicular to the line between two auto points.

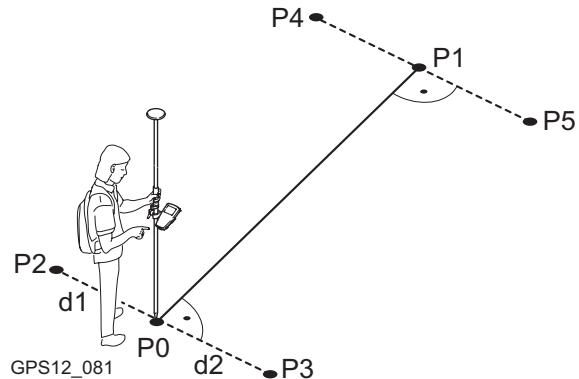

- P0 First auto point
- P1 Second auto point
- P2 First offset point for P0
- P3 Second offset point for P0
- P4 First offset point for P1
- P5 Second offset point for P1
- d1 Horizontal offset to the left
- d2 Horizontal offset to the right

Three or more auto points

The first offset points are computed perpendicular to the line between the first and the second auto point.

The last offset point is computed perpendicular to the line between the last auto point and the one before.

All other offset points are computed on a bearing. The bearing is half of the angle between the last and the next measured auto point.

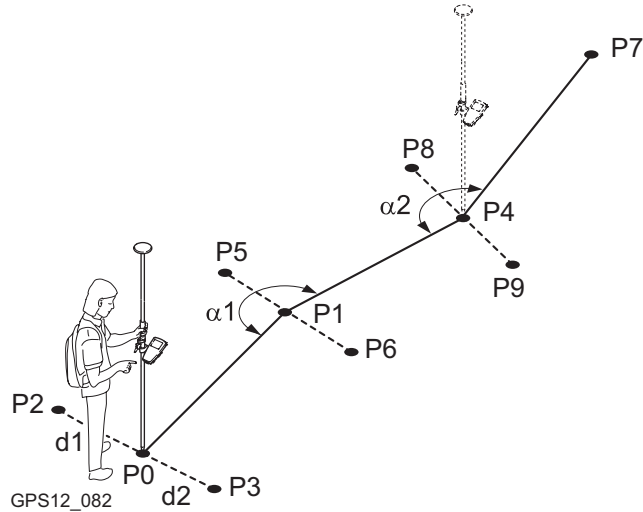

- P0 First auto point
- P1 Second auto point
- P2 First offset point for P0
- P3 Second offset point for P0
- P4 Third auto point
- P5 First offset point for P1
- P6 Second offset point for P1
- P7 Fourth auto point
- P8 First offset point for P4
- P9 Second offset point for P4
- d1 Horizontal offset to the left
- d2 Horizontal offset to the right
- α_1 Angle between P0 and P4
- α_2 Angle between P1 and P7

45.4.2

Configuring Offset Points

Requirements

<Store: DBX(Pts&Codes)> in **SURVEY Configuration, Auto Points** page.

Access step-by-step

Step	Description
1.	Refer to "44.1 Accessing Survey" to access SURVEY Survey: Job Name .
2.	PAGE (F6) until the Auto page is active.
3.	OFST1 (F4) or OFST2 (F5) to access SURVEY Auto Points - Offset .

SURVEY

Auto Points - Offset,
General page

Horiz Offset : 5.3200 m
Height Offset: 1.0000 m

Identifier : 0S1
Prefix/Suffix: Prefix

**CONT (F1)**

To accept changes and return to the screen from where this screen was accessed.

OFST2 (F2) and OFST1 (F2)

To switch between configuring offset point type one and two.

PAGE (F6)

To change to another page on this screen.

Description of fields

Field	Option	Description
<Store Offset1:> and <Store Offset2:>	Yes	Activates logging of offset points.  All other fields on the screen are active and can be edited with this setting.
	No	Deactivates logging of offset points and all fields on this screen.
<Horiz Offset:>	User input	The horizontal offset between -1000 m and 1000 m at which the offset point is collected.
<Height Offset:>	User input	The height offset between -100 m and 100 m from the related auto point.
<Identifier:>	User input	The identifier with up to four characters is added in front of or at the end of the ID of the auto point. This ID is then used as the point ID for the related offset point. This could support an automatic workflow into CAD packages including setting symbols and stringing lines.
<Prefix/Suffix:>	Prefix	Adds the setting for <Identifier:> in front of the auto point ID.
	Suffix	Adds the setting for <Identifier:> at the end of the auto point ID.

Next step

PAGE (F6) changes to the **Code** page.

SURVEY**Auto Points - Offset,
Code page**

The setting for **<Themadc Codes:>** in **CONFIGURE Coding & Linework** determines the availability of the fields and softkeys.

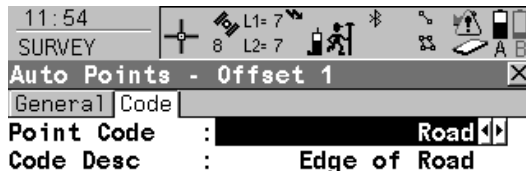
**CONT (F1)**

To accept changes and return to the screen from where this screen was accessed.

NEW-A (F2)

To create additional attributes for the selected **<Code:>**. Available for **<Themadc Codes: With Codelist>**.

NAME (F3) or VALUE (F3)

To highlight **<Attribute n:>** or the field for the attribute value. The name of **<Attribute n:>** can be edited and an attribute value can be typed in. Available for **<Themadc Codes: With Codelist>**. Available for attributes for which an attribute name can be typed in.

LAST (F4)

To recall the last used attribute values for the selected code. Available for **<Themadc Codes: With Codelist>**.

DEFLT (F5)

To recall the default attribute values for the selected code. Available for **<Themadc Codes: With Codelist>**.

PAGE (F6)

To change to another page on this screen.

Description of fields

Field	Option	Description
<Point Code:>	Choicelist	The thematical code for the offset point. Available for <Themac Codes: With Codelist>. The setting for <Show Codes:> in CONFIGURE Coding & Linework determines if either all codes or only point codes are available. The attributes are shown as output, input or choicelist fields depending on their definition.
<Code:>	User input	The thematical code for the offset point. Available for <Themac Codes: Without Codelist>. Codes can be typed in but not selected from a codelist. A check is performed to see if a point code of this name already exists in the job. If so, the according attributes are shown.
<Code Desc:>	Output	Available for <Themac Codes: With Codelist>. The description of the code.
<Attribute n:>	User input	Available for <Themac Codes: Without Codelist>. Up to three attribute values can be stored.

Next step

IF	THEN
offset point configuration is finished	CONT (F1) to return to SURVEY Survey: Job Name.

IF	THEN
a second offset point is to be configured	PAGE (F6) and then OFST2 (F2) or OFST1 (F2) to change to SURVEY Auto Points - Offset for the second point.

Example for offset point ID's

The offset point ID is a combination of the auto point ID and an identifier as a prefix or suffix. The right most part of the auto point ID is incremented within the point ID. The auto point ID is truncated from the left if the length of the auto point ID plus identifier prefix or suffix is greater than 16 characters.

Auto point ID	Identifier	Prefix/Suffix	Offset point ID
Auto1234 Auto1235	OS1	Prefix	OS1Auto1234 OS1Auto1235 ...
Auto1234 Auto1235	OS1	Suffix	Auto1234OS1 Auto1235OS1 ...



Refer to "19.1 ID Templates" for more information on point ID's.

45.4.3

Working Example

Description

Application:	Pick up points along the centre line, to the right and to the left of a road.
Working technique:	Real-time kinematic.
Goal:	Points are to be picked up automatically every 5 m while walking along the centre line. The points to the right and to the left of the road are to be picked up automatically with those of the centre line. The auto point ID's are CL0001, CL0002, The offset point ID's are OSCL0001, OSCL0002, ... for the right side of the road and CL0001OS, CL0002OS, ... for the left side. The offset to the right and to the left is 3 m. The height difference is -0.3 m to the right and 0.3 m to the left.

Diagram

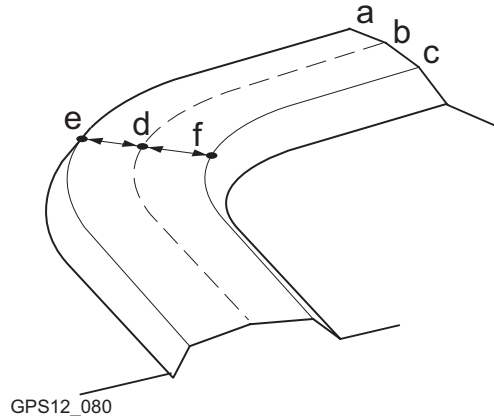

- a) Left side of the road
- b) Centre line
- c) Right side of the road
- d) CL0001
- e) OSCL0001
- f) CL0001OS





Requirements

- A real-time reference is running.
- For the rover: **<R-Time Mode: Rover>** in **CONFIGURE Real-Time Mode**.
- The default display mask for **SURVEY Survey: Job Name, Auto** page is used.
- **<Store: DBX(Pts&Codes)>** in **SURVEY Configuration, Auto Points** page.
- **<Distance Unit: Metres (m)>** in **CONFIGURE Units & Formats, Units** page.
- An ID template for the auto points is configured. Refer to "19.1.6 Working Example" for information on how to configure ID templates.

Field procedure step-by-step

Step	Description
1.	Main Menu: Survey
2.	SURVEY Survey Begin

Step	Description
	Select a job and a configuration set with the settings mentioned above.
3.	CONF (F2) to access SURVEY Configuration .
4.	SURVEY Configuration, Auto Points page <Log Auto Pts: Yes> <Log By: Distance> <Log Every: 5.0000> <Store: File(Pts Only)>
5.	CONT (F1) to return to SURVEY Survey Begin .
6.	CONT (F1) to access SURVEY Survey: Job Name .
7.	PAGE (F6) until the Auto page is active.
8.	OFST1 (F4) to configure the offset points for the right side of the road.
9.	SURVEY Auto Points - Offset 1, General page <Store Offset1: Yes> <Horiz Offset: 3.0000> <Height Offset: -0.3000> <Identifier: OS> <Prefix/Suffix: Prefix>
10.	OFST2 (F2) to configure the offset points for the left side of the road.
11.	SURVEY Auto Points - Offset 2, General page <Store Offset2: Yes>

Step	Description
	<p><Horiz Offset: -3.0000></p> <p><Height Offset: 0.3000></p> <p><Identifier: OS></p> <p><Prefix/Suffix: Suffix></p>
12.	CONT (F1) closes the screen and returns to SURVEY Survey: Job Name, Auto page.
13.	<p>SURVEY Survey: Job Name, Auto page</p> <p>START (F1) starts logging of auto points and offset points.</p>
14.	Walk along the centre line of the road as far as points need to be picked up.
	OCUPY (F3) to store an auto point at any time.
	OFST1 (F4) to change the offset or the height difference between the auto points on the centre line and the right side of the road.
	OFST2 (F5) to change the offset or the height difference between the auto points on the centre line and the left side of the road.
15.	STOP (F1) ends recording of auto points and offset points.
	The stopping of auto points is indicated in the position mode icon.
16.	After finishing the survey, import the data into a CAD package. If the offset point ID's or codes fulfil the requirements of the CAD package, the offset points to the right and to the left of the road are automatically strung together.

46**Survey - Hidden Points****46.1****Overview****Description**

Hidden points cannot be measured directly by GPS. This is because they can not be physically reached or because satellites are obstructed, for example by trees or tall buildings.

- A hidden point can be calculated by measuring distances and/or azimuths to the hidden point using a hidden point measurement device. Or for distances a tape may be used. Refer to "22.7 Hidden Point" for information on supported hidden point measurement devices.
- Additional auxiliary points may be manually occupied.
- Bearings may be computed from previously occupied points.

In contrast to the COGO application program, hidden point measurements is more of a measuring application program than a calculation application program.

Example

Application:

Completing a survey of telegraph poles for a telecommunication company.

Aim:

The telegraph poles must be surveyed to 0.3 m accuracy in plan but height is not of concern.

Use of hidden point measurements: For poles surrounded by heavy undergrowth where it is not possible to directly measure the pole without taking a lot of time to cut a path through the undergrowth.



Changing coordinates of a point which has been previously used in hidden point measurements does not result in the hidden point being recomputed.



Hidden point measurements are possible for **<R-Time Mode: Rover>** and **<R-Time Mode: None>**. For **<R-Time Mode: None>** the hidden point can be calculated in LGO.

Hidden point measurement methods

A hidden point can be measured by

- Bearing and distance
 - Chainage and offset
 - Double bearing
 - Backwards bearing and distance
 - Double distance
-

Magnetic declination

Any magnetic declination configured for **<Mag Declin:>** in **CONFIGURE Units & Formats, Angle** page is applied when the hidden points are computed. The azimuth must be entered manually or it must be measured with a hidden point measurements device.

Heights

Heights are taken into account if configured. Refer to "22.7 Hidden Point" for information on configuring height offsets.

<Device Ht:> and **<Target Ht:>** configured in **CONFIGURE Hidden Pt Device Offsets** are applied when the hidden points are computed. **<ΔHeight:>** in **HIDDEN PT Hidden Point Measurement** is the value directly from the hidden point measuring device.

Coding of hidden points	<ul style="list-style-type: none">• Thematical coding: Available in HIDDEN PT Hidden Point Result after the calculation of a hidden point. Thematical coding of hidden points is identical to coding of manually occupied points. Refer to "11 Coding" for information on coding.• Free coding: Can be started while in HIDDEN PT Hidden Point Measurement. The code and attributes of the last entered free code in the active job is displayed. It cannot be changed.• Quick coding: Not available.
Properties of hidden points	<p>The properties stored with hidden points are:</p> <ul style="list-style-type: none">• Class: MEAS• Sub class: Hidden Point• Source: Bearing-Distance, Double Bearing, Double Distance, Chainage-Offset or Backwrd Brg-Dist depending on the hidden point measurement method used• Instrument source: GPS
Averaging of hidden points	<p>An average is calculated for hidden points if a point of class MEAS already exists with the same point ID.</p>
Configure hidden point measurements	<p>Refer to "22.7 Hidden Point" for information on how to configure hidden point measurements.</p>
	<p><Azimuth:> is used throughout this chapter. This should always be considered to also mean <Bearing:>.</p>
Auxiliary points	<p>Auxiliary points are used to compute azimuths required for the calculation of hidden point coordinates. Auxiliary points can be points existing in the job or they can be manually occupied. The point ID template configured for <Auxil Pts:> in CONFIGURE ID Templates is applied. Refer to "19.1 ID Templates" for information on ID templates.</p>

46.2

Accessing Hidden Point Measurement



Hidden point measurements are possible from the Survey application program and when the Survey application program screen is called from another application program, for example from Stakeout.

Access

Press **H PNT (F5)** in **SURVEY Survey: Job Name, Survey** page.

OR

Press a hot key configured to access the screen **HIDDEN PT Hidden Point Measurement**. Refer to "6.1 Hot Keys" for information on hot keys.

OR

Press **USER**. Refer to "6.2 USER Key" for information on the **USER** key.

HIDDEN PT Hidden Point Measurement

The setting for **<Method:>** on this screen determines the availability of the subsequent fields and softkeys. They are explained in the following chapters related to the individual methods.

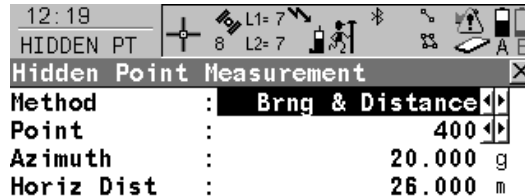

CALC (F1)

To calculate the hidden point and to display the results.

SHIFT CONF (F2)

To configure hidden point measurements. Refer to "22.7 Hidden Point".

Next step

IF	THEN
<Method: Brng & Distance>	Refer to "46.3.1 Bearing & Distance".
<Method: Double Bearing>	Refer to "46.3.2 Double Bearing".
<Method: Double Distance>	Refer to "46.3.3 Double Distance".
<Method: Chainage & Offset>	Refer to "46.3.4 Chainage & Offset".
<Method: Back Brng & Dist>	Refer to "46.3.5 Backwards Bearing & Distance".
heights are to be included	Refer to "46.6 Hidden Point Measurement Including Heights".

46.3

46.3.1

Measuring Hidden Points

Bearing & Distance

Description

One point must be known. It

- may already exist in the job.
- may be manually occupied during the hidden point measurements.
- may be manually typed in.

The distance and the bearing from the known point to the hidden point are to be determined. An auxiliary point helps compute the bearing which might not be known. The auxiliary point may be measured in the direction from the known point to the hidden point.

Diagram

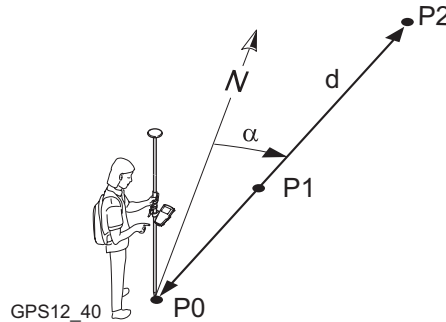

Known

P0 Known point, <Point:>

To be measured

d Distance from P0 to P2

alpha Bearing from P0 to P2





P1 Auxiliary point, optional





Unknown



P2 Hidden point

Measure a hidden point with Bearing & Distance step-by-step

The following table explains the most common settings. Refer to the stated chapter for more information on screens.

Step	Description	Refer to chapter
	A hidden point measurement device can be attached to the receiver such that the measurements are automatically transferred to the receiver.	23.1.7
1.	Refer to "46.2 Accessing Hidden Point Measurement" to access HIDDEN PT Hidden Point Measurement .	
	SHIFT CONF (F2) to configure hidden point measurements.	23.1.7
2.	HIDDEN PT Hidden Point Measurement <Method: Brng & Distance> <Point:> The point ID of the current position. This is the known point for the calculation of the hidden point. Select a point stored in the job.	
	SURVY (F5) when <Point:> is highlighted. To manually occupy the known point for the calculation of the hidden point.	44.3
	To manually type in coordinates for the known point open the choicelist when <Point:> is highlighted. Press NEW (F2) to create a new point.	9.3.2
3.	HIDDEN PT Hidden Point Measurement <Azimuth:> The azimuth from <Point:> to the hidden point. Type in an azimuth. When a hidden point measurement device is attached to the receiver to measure the azimuth, the value is automatically transferred.	

Step	Description	Refer to chapter
	SUN (F3) when <Azimuth:> is highlighted. The azimuth from the direction of the sun to <Point:> is computed.	46.4.1
	AZMTH (F4) when <Azimuth:> is highlighted. To select or manually occupy an auxiliary point and to compute the azimuth.	46.4.2
	EAO (F2) available for <EAO Method: New for Each Point> or <EAO Method: Permanent> in CONFIGURE Hidden Point Device Offsets . To change or enter an External Angle Offset .	23.1.7
4.	<p>HIDDEN PT Hidden Point Measurement</p> <p><Horiz Dist:> The horizontal distance from <Point:> to the hidden point.</p> <p>Type in a distance. When a hidden point measurement device is attached to the receiver to measure the distance, the value is automatically transferred.</p>	
	DIST (F2) available for Leica Disto™ pro ⁴ and Leica Disto™ pro ⁴ a when a distance field is highlighted. To measure the distance without pressing DIST on the Disto.	
	SLOPE (F5) when <Horiz Dist:> is highlighted. To measure a slope distance and an elevation angle or percentage grade. The values are used to compute the horizontal distance.	46.5
5.	CALC (F1) calculates the hidden point and displays the results in HIDDEN PT Hidden Point Result, Result page.	
6.	HIDDEN PT Hidden Point Result, Result page	

Step	Description	Refer to chapter
	<p><Point ID:> The identifier for the hidden point. The configured point ID template is used. The ID can be changed.</p> <p>Type in a point ID.</p>	
	<p>SHIFT INDIV (F5) for an individual point ID independent of the ID template. SHIFT RUN (F5) changes back to the next ID from the configured ID template.</p>	19.1
	<p>NEXT (F5) to store the hidden point and to return to HIDDEN PT Hidden Point Measurement. Another hidden point can be measured.</p>	
7.	<p>PAGE (F6) changes to Code page.</p>	
8.	<p>HIDDEN PT Hidden Point Result, Code page</p> <p><Code:>/<Point Code:> The thematical code. All codes of the job can be selected.</p> <p><Attribute n:> The attributes for the thematical code. The behaviour of the fields depend on their definition in the codelist.</p> <p>Type in a code if required.</p>	11
9.	<p>PAGE (F6) changes to the Plot page.</p>	
10.	<p>HIDDEN PT Hidden Point Result, Plot page</p> <p>Measured distances are indicated by solid arrows.</p> <p>Bearings are indicated by half solid and half dashed arrows.</p>	32.6

Step	Description	Refer to chapter
	SHIFT QUIT (F6) to not store the hidden point and to return to the screen from where HIDDEN PT Hidden Point Measurement was accessed.	
11.	STORE (F1) to store the hidden point and to return to the screen from where HIDDEN PT Hidden Point Measurement was accessed.	

46.3.2

Double Bearing

Description

Two points must be known. They

- may already exist in the job.
- may be manually occupied during the hidden point measurements.
- may be manually typed in.

The bearings from the known points to the hidden point are to be determined. Auxiliary points help compute the bearings which might not be known. Auxiliary points may be measured in the direction from the known points to the hidden point.

Diagram

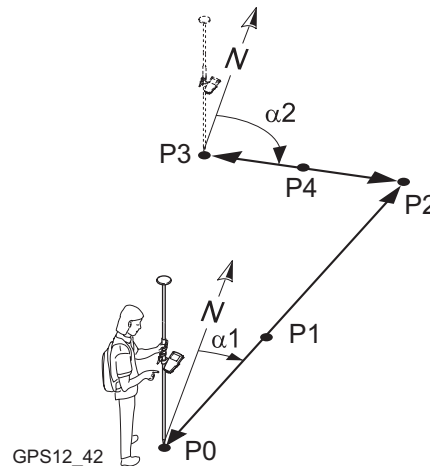
**Known**

P0 First known point, <Point A:>

P3 Second known point, <Point B:>

To be measured

α_1 Bearing from P0 to P2

α_2 Bearing from P3 to P2

P1 First auxiliary point, optional





P4 Second auxiliary point, optional



Unknown



P2 Hidden point

Measure a hidden point with Double Bearing step-by-step

The following table explains the most common settings. Refer to the stated chapter for more information on screens.

Step	Description	Refer to chapter
	A hidden point measurement device can be attached to the receiver such that the measurements are automatically transferred to the receiver.	23.1.7
1.	Refer to "46.2 Accessing Hidden Point Measurement" to access HIDDEN PT Hidden Point Measurement .	
	SHIFT CONF (F2) to configure hidden point measurements.	22.7
2.	HIDDEN PT Hidden Point Measurement <Method: Double Bearing> <Point A:> The point ID of the current position. This is the first known point for the calculation of the hidden point. Select a point stored in the job.	
	SURVY (F5) when <Point A:> is highlighted. To manually occupy the first known point for the calculation of the hidden point.	44.3
	To manually type in coordinates for the known point open the choicelist when <Point A:> is highlighted. Press NEW (F2) to create a new point.	9.3.2
3.	HIDDEN PT Hidden Point Measurement <Azimuth:> The azimuth from <Point A:> to the hidden point.	

Step	Description	Refer to chapter
	Type in an azimuth. When a hidden point measurement device is attached to the receiver to measure the azimuth, the value is automatically transferred.	
	SUN (F3) when <Azimuth:> is highlighted. The azimuth from the direction of the sun to <Point A:> is computed.	46.4.1.
	AZMTH (F4) when <Azimuth:> is highlighted. To select or manually occupy an auxiliary point and to compute the azimuth.	46.4.2.
	EAO (F2) available for <EAO Method: New for Each Point> or <EAO Method: Permanent> in CONFIGURE Hidden Point Device Offsets . To change or enter an External Angle Offset .	22.7
4.	HIDDEN PT Hidden Point Measurement <Point B:> The point ID of the current position. This is the second known point for the calculation of the hidden point. The procedure of measuring the hidden point from <Point B:> is the same as from <Point A:> . Repeat steps 2. and 3.	
5.	CALC (F1) calculates the hidden point and displays the results in HIDDEN PT Hidden Point Result, Result page.	
6.	HIDDEN PT Hidden Point Result, Result page <Point ID:> The identifier for the hidden point. The configured point ID template is used. The ID can be changed. <Check Dist AB:> The computed horizontal distance between <Point A:> and <Point B:> .	

Step	Description	Refer to chapter
	<p><Check Brg AB:> The computed bearing from <Point A:> to <Point B:>.</p> <p><Check Dist A:> The computed horizontal distance between <Point A:> and the hidden point.</p> <p><Check Dist B:> The computed horizontal distance between <Point B:> and the hidden point.</p> <p>Check the computed distances and the bearing.</p>	
7.	<p>Are the computed distances and bearings correct?</p> <ul style="list-style-type: none"> • If yes, continue with step 8. • If no, continue with the row below step 12. 	
8.	Type in a point ID.	
	<p>SHIFT INDIV (F5) for an individual point ID independent of the ID template. SHIFT RUN (F5) changes back to the next ID from the configured ID template.</p>	19.1
	<p>NEXT (F5) to store the hidden point and to return to HIDDEN PT Hidden Point Measurement. Another hidden point can be measured.</p>	
9.	PAGE (F6) changes to the Code page.	
10.	<p>HIDDEN PT Hidden Point Result, Code page</p> <p><Code:>/<Point Code:> The thematical code. All codes of the job can be selected.</p>	11

Step	Description	Refer to chapter
	<Attribute n:> The attributes for the thematical code. The behaviour of the fields depend on their definition in the codelist. Type in a code if required.	
11.	PAGE (F6) changes to the Plot page.	
12.	HIDDEN PT Hidden Point Result, Plot page Bearings are indicated by half solid and half dashed arrows.	32.6
	SHIFT QUIT (F6) to not store the hidden point and to return to the screen from where HIDDEN PT Hidden Point Measurement was accessed.	
13.	STORE (F1) to store the hidden point and to return to the screen from where HIDDEN PT Hidden Point Measurement was accessed.	

46.3.3

Double Distance

Description

Two points must be known. They

- may already exist in the job.
- may be manually occupied during the hidden point measurements.
- may be manually typed in.

The distances from the known points to the hidden points are to be determined. The location of the hidden point relative to the line between the two known points is to be defined.

Diagram

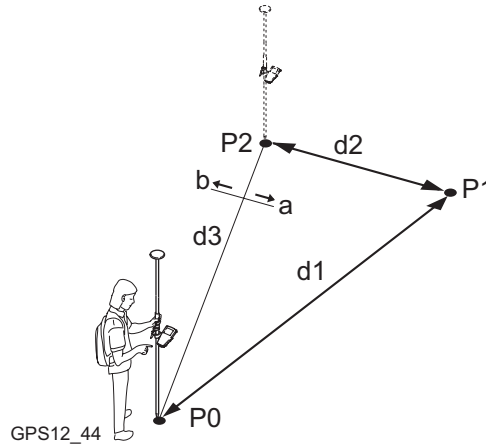

Known

P0 First known point, **<Point A:>**

P2 Second known point, **<Point B:>**

d3 Line from P0 to P2

a Right of d3

b Left of d3

To be measured

d1 Distance from P0 to P1





d2 Distance from P2 to P1



Unknown

P1 Hidden point



Measure a hidden point with Double Distance step-by-step

The following table explains the most common settings. Refer to the stated chapter for more information on screens.

Step	Description	Refer to chapter
	A hidden point measurement device can be attached to the receiver such that the measurements are automatically transferred to the receiver.	23.1.7
1.	Refer to "46.2 Accessing Hidden Point Measurement" to access HIDDEN PT Hidden Point Measurement .	
	SHIFT CONF (F2) to configure hidden point measurements.	22.7
2.	HIDDEN PT Hidden Point Measurement <Method: Double Distance> <Point A:> The point ID of the current position. This is the first known point for the calculation of the hidden point. Select a point stored in the job.	
	SURVY (F5) when <Point A:> is highlighted. To manually occupy the first known point for the calculation of the hidden point.	44.3
	To manually type in coordinates for a known point open the choicelist when <Point A:> is highlighted. Press NEW (F2) to create a new point.	9.3.2
3.	HIDDEN PT Hidden Point Measurement <Horiz Dist:> The horizontal distance from <Point A:> to the hidden point.	

Step	Description	Refer to chapter
	Type in a distance. When a hidden point measurement device is attached to the receiver to measure the distance, the value is automatically transferred.	
	DIST (F2) available for Leica Disto™ pro ⁴ and Leica Disto™ pro ⁴ a when a distance field is highlighted. To measure the distance without pressing DIST on the Disto.	
	SLOPE (F5) when <Horiz Dist:> is highlighted. To measure a slope distance and an elevation angle or percentage grade. The values are used to compute the horizontal distance.	46.5
4.	<p>HIDDEN PT Hidden Point Measurement</p> <p><Point B:> The point ID of the current position. This is the second known point for the calculation of the hidden point.</p> <p>The procedure of measuring the hidden point from <Point B:> is the same as from <Point A:>. Repeat steps 2. and 3.</p>	
5.	<p>HIDDEN PT Hidden Point Measurement</p> <p><Location:> The location of the hidden point relative to the line from <Point A:> to <Point B:>.</p> <p>Select the location.</p>	
6.	CALC (F1) calculates the hidden point and displays the results in HIDDEN PT Hidden Point Result, Result page.	

Step	Description	Refer to chapter
7.	<p>HIDDEN PT Hidden Point Result, Result page</p> <p><Point ID:> The identifier for the hidden point. The configured point ID template is used. The ID can be changed.</p> <p><Check Chng A:> The computed distance on the line from <Point A:> to <Point B:> from <Point A:> to the point of intersection with <Check Offset:>.</p> <p><Check Chng B:> The computed distance on the line from <Point B:> to <Point A:> from <Point B:> to the point of intersection with <Check Offset:>.</p> <p><Check Offset:> The computed perpendicular distance from the hidden point to the line from <Point> A> to <Point B:>.</p> <p><Check Dist AB:> The computed horizontal distance between <Point A:> and <Point B:>.</p> <p>Check the computed distances.</p>	paragraph "Computed distances on HIDDEN PT Hidden Point Result, Result page"
8.	<p>Are the computed distances correct?</p> <ul style="list-style-type: none"> • If yes, continue with step 9. • If no, continue with the row below step 13. 	
9.	Type in a point ID.	
	SHIFT INDIV (F5) for an individual point ID independent of the ID template. SHIFT RUN (F5) changes back to the next ID from the configured ID template.	19.1

Step	Description	Refer to chapter
	NEXT (F5) to store the hidden point and to return to HIDDEN PT Hidden Point Measurement . Another hidden point can be measured.	
10.	PAGE (F6) changes to the Code page.	
11.	HIDDEN PT Hidden Point Result, Code page <Code:>/<Point Code:> The thematical code. All codes of the job can be selected. <Attribute n:> The attributes for the thematical code. The behaviour of the fields depend on their definition in the codelist. Type in a code if required.	11
12.	PAGE (F6) changes to the Plot page.	
13.	HIDDEN PT Hidden Point Result, Plot page Measured distances are indicated by solid arrows.	32.6
	SHIFT QUIT (F6) to not store the hidden point and to return to the screen from where HIDDEN PT Hidden Point Measurement was accessed.	
14.	STORE (F1) to store the hidden point and to return to the screen from where HIDDEN PT Hidden Point Measurement was accessed.	

Computed distances on
HIDDEN PT Hidden
Point Result, Result
page

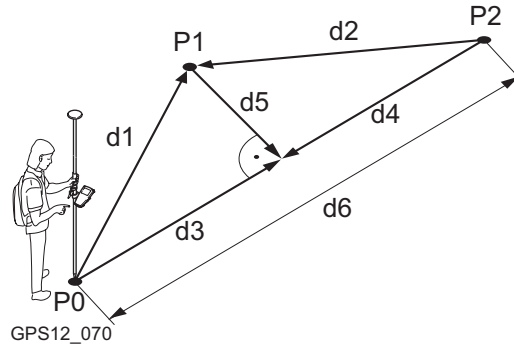

- P0 First known point, **<Point A:>**
- P1 Hidden point
- P2 Second known point, **<Point B:>**
- d1 Distance from P0 to P1
- d2 Distance from P2 to P1
- d3 **<Check Chng A:>**
- d4 **<Check Chng B:>**
- d5 **<Check Offset:>**
- d6 **<Check Dist AB:>**

46.3.4

Chainage & Offset

Description

Two points must be known. They

- may already exist in the job.
- may be manually occupied during the hidden point measurements.
- may be manually typed in.

The chainage from one known point along the line between the two known points must be determined. The offset of the hidden point to the line between the two known points must be determined.

Diagram

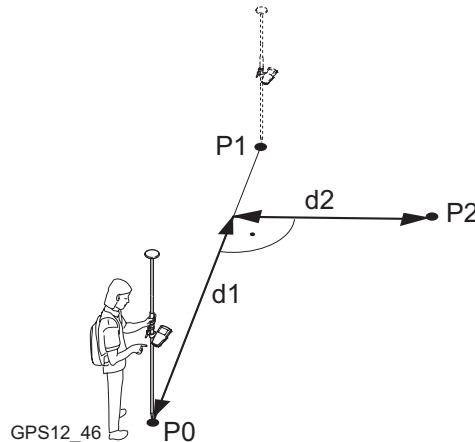

Known

P0 First known point, <Point A:>

P1 Second known point, <Point B:>

To be measured

d1 Chainage





d2 Offset



Unknown

P2 Hidden point



Measure a hidden point with Chainage & Offset step-by-step

The following table explains the most common settings. Refer to the stated chapter for more information on screens.

Step	Description	Refer to chapter
	A hidden point measurement device can be attached to the receiver such that the measurements are automatically transferred to the receiver.	23.1.7
1.	Refer to "46.2 Accessing Hidden Point Measurement" to access HIDDEN PT Hidden Point Measurement .	
	SHIFT CONF (F2) to configure hidden point measurements.	23.1.7
2.	HIDDEN PT Hidden Point Measurement <Method: Chainage & Offset> <Point A:> The point ID of the current position. This is the first known point for the calculation of the hidden point. Select a point stored in the job.	
	SURVY (F5) when <Point A:> is highlighted. To manually occupy the first known point for the calculation of the hidden point.	44.3
	To manually type in coordinates for the known point open the choicelist when <Point A:> is highlighted. Press NEW (F2) to create a new point.	9.3.2
3.	HIDDEN PT Hidden Point Measurement <Point B:> The point ID of the current position. This is the second known point for the calculation of the hidden point.	

Step	Description	Refer to chapter
	Select a point stored in the job.	
	SURVY (F5) when <Point B:> is highlighted. To manually occupy the first known point for the calculation of the hidden point.	44.3
	To manually type in coordinates for the known point open the choicelist when <Point B:> is highlighted. Press NEW (F2) to create a new point.	9.3.2
4.	<p>HIDDEN PT Hidden Point Measurement</p> <p><Chainage:> The chainage from one known point along the line between the two known points. Looking from the point selected in <Chainage From:>, a positive chainage is towards the second known point. A negative chainage is into the opposite direction of the second known point.</p> <p>Type in a distance and select its direction. When a hidden point measurement device is attached to the receiver to measure the distance, the value is automatically transferred.</p>	
	DIST (F2) available for Leica Disto™ pro ⁴ and Leica Disto™ pro ⁴ a when a distance field is highlighted. To measure the distance without pressing DIST on the Disto.	
5.	POS? (F4) to determine chainage and offset of the current position relative to the line between the two known points. The values are displayed in <Chainage:> and <Offset:> . The point from where the chainage has been measured is selected in <Chainage From:> .	

Step	Description	Refer to chapter
	SLOPE (F5) when <Chainage:> is highlighted. To measure a slope distance and an elevation angle or percentage grade. The values are used to compute the horizontal distance.	46.5
6.	<p>HIDDEN PT Hidden Point Measurement</p> <p><Offset:> The offset of the hidden point to the line between the two known points.</p> <p><Location:> The location of the hidden point relative to the line from <Point A:> to <Point B:>.</p> <p>Type in a distance and select its location. When a hidden point measurement device is attached to the receiver to measure the distance, the value is automatically transferred.</p> <p>The procedure of measuring the offset is the same as measuring the chainage. Refer to step 4.</p>	
7.	<p>HIDDEN PT Hidden Point Measurement</p> <p><Chainage From:> The point from where the chainage has been measured.</p> <p>Select the point.</p>	
8.	CALC (F1) calculates the hidden point and displays the results in HIDDEN PT Hidden Point Result, Result page.	
9.	HIDDEN PT Hidden Point Result, Result page	

Step	Description	Refer to chapter
	<p><Point ID:> The identifier for the hidden point. The configured point ID template is used. The ID can be changed.</p> <p><Check Dist A:> The computed horizontal distance between <Point A:> and the hidden point.</p> <p><Check Dist B:> The computed horizontal distance between <Point B:> and the hidden point.</p> <p><Check Dist AB:> The computed horizontal distance between <Point A:> and <Point B:>.</p> <p>Check the computed distances.</p>	paragraph "Computed distances on HIDDEN PT Hidden Point Result, Result page"
10.	<p>Are the computed distances correct?</p> <ul style="list-style-type: none"> • If yes, continue with step 11. • If no, continue with the row below step 15. 	
11.	Type in a point ID.	
	SHIFT INDIV (F5) for an individual point ID independent of the ID template. SHIFT RUN (F5) changes back to the next ID from the configured ID template.	19.1
	NEXT (F5) to store the hidden point and to return to HIDDEN PT Hidden Point Measurement . Another hidden point can be measured.	
12.	PAGE (F6) changes to the Code page.	
13.	HIDDEN PT Hidden Point Result, Code page	11

Step	Description	Refer to chapter
	<p><Code:>/<Point Code:> The thematical code. All codes of the job can be selected.</p> <p><Attribute n:> The attributes for the thematical code. The behaviour of the fields depend on their definition in the codelist.</p> <p>Type in a code if required.</p>	
14.	PAGE (F6) changes to the Plot page.	
15.	<p>HIDDEN PT Hidden Point Result, Plot page</p> <p>Measured distances are indicated by solid arrows.</p>	32.6
	<p>SHIFT QUIT (F6) to not store the hidden point and to return to the screen from where HIDDEN PT Hidden Point Measurement was accessed.</p>	
16.	<p>STORE (F1) to store the hidden point and to return to the screen from where HIDDEN PT Hidden Point Measurement was accessed.</p>	

46.3.5

Backwards Bearing & Distance

Description

In order to compute the hidden point, the measurements are taken from the hidden point. One point must be known. It

- may already exist in the job.
- may be manually occupied during the hidden point measurements.
- may be manually typed in.

The distance and the bearing from the hidden point to the known point are to be determined. An auxiliary point helps compute the bearing which might not be known. An auxiliary point may be measured in the direction from the hidden point to the known point.

Diagram

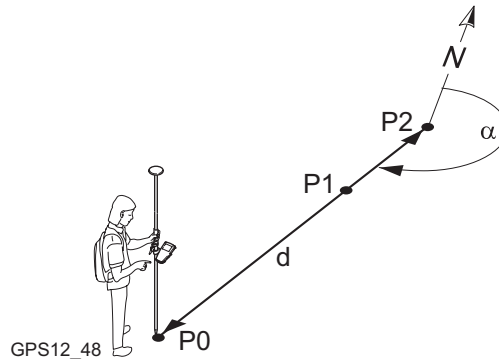

Known

P0 Known point, <Point:>

To be measured

α Bearing from P2 to P0

d Distance from P2 to P0

P1 Auxiliary point, optional

Unknown

P2 Hidden point

**Measure a hidden point
with Backwards
Bearing & Distance
step-by-step**

All steps are identical with those for measuring a hidden point using **Bearing & Distance**. The measurements are taken from the hidden point to **<Point:>**. Refer to "46.3.1 Bearing & Distance".

46.4

46.4.1

Computing an Azimuth

Using the Sun

Description

The azimuth for a hidden point measurement can be computed using a known point and the sun. The known point can be manually occupied. The location of the hidden point can be away from the sun or in the direction towards the sun. Ensure the shadow of the pole falls in the direction of the point.

Diagram

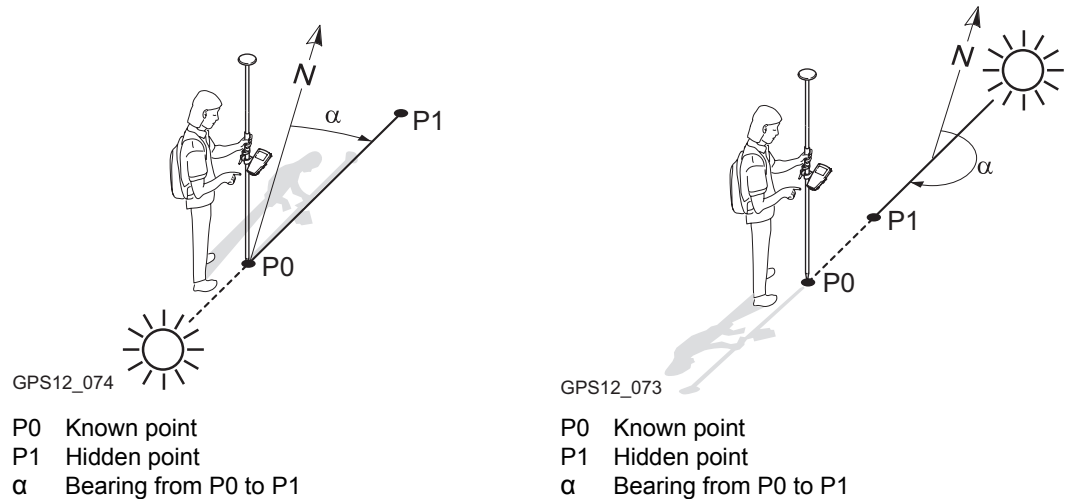

Computing an azimuth using the sun step-by-step

Step	Description
1.	Refer to "46.2 Accessing Hidden Point Measurement" to access HIDDEN PT Hidden Point Measurement .
2.	HIDDEN PT Hidden Point Measurement Select <Method: Brng & Distance> , <Method: Double Bearing> or <Method: Back Brng & Dist> .
3.	<Point> , <Point A> or <Point B> Select the known point.
4.	Highlight <Azimuth:> .
5.	SUN (F3)
6.	Is the hidden point in the direction towards the sun? <ul style="list-style-type: none">• If yes, TOWRD (F4).• If no, AWAY (F6).
7.	HIDDEN PT Hidden Point Measurement The azimuth is computed and displayed in <Azimuth:> .

46.4.2

Using Auxiliary Point

Description

The azimuth for a hidden point measurement can be computed using an auxiliary point. The auxiliary point

- may already exist in the job.
- may be manually occupied during the hidden point measurements.
- may be manually typed in.

The location of the auxiliary point can be in the direction towards the hidden point or away from the hidden point.

Diagram

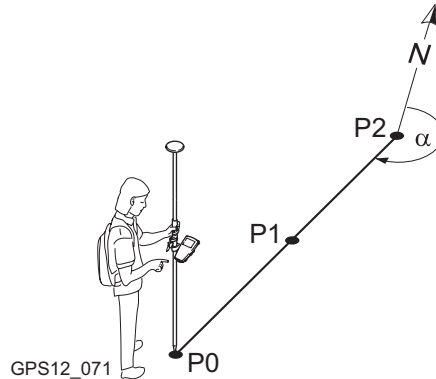

- P0 Known point
P1 Auxiliary point, <Azimuth Pt:>
P2 Hidden point
 α Bearing from P2 to P0

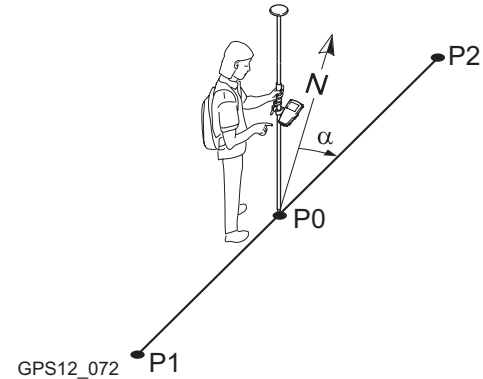

- P0 Known point
P1 Auxiliary point, <Azimuth Pt:>
P2 Hidden point
 α Bearing from P0 to P2

Access step-by-step

Step	Description
1.	Refer to "46.2 Accessing Hidden Point Measurement" to access HIDDEN PT Hidden Point Measurement .
2.	HIDDEN PT Hidden Point Measurement Select <Method: Brng & Distance> , <Method: Double Bearing> or <Method: Back Brng & Dist> .
3.	AZMTH (F4) when <Azimuth:> is highlighted to access HIDDEN PT Choose Azimuth Point .

HIDDEN PT
Choose Azimuth Point

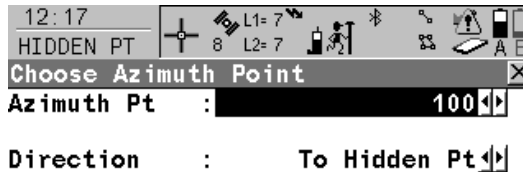

CONT (F1)

To accept changes and return to the screen from where this screen was accessed. The azimuth is computed and displayed in **<Azimuth:>** in **HIDDEN PT Hidden Point Measurement**.

SURVY (F5)

Available for **<Azimuth Pt:>** being highlighted. To manually occupy the auxiliary point for the calculation of the azimuth. Refer to "44.3 Surveying Points".

Description of fields

Field	Option	Description
<Azimuth Pt:>	Choicelist	The auxiliary point for the calculation of the azimuth. All points from MANAGE Data: Job Name can be selected.
<Direction:>	Choicelist	The location of the auxiliary point relative to the hidden point.

Next step

CONT (F1) closes the screen and returns to the screen from where **HIDDEN PT Choose Azimuth Point** was accessed.

46.5

Computing Horizontal Distances from Slope Distances

Description

The horizontal distance for a hidden point measurement can be computed using a slope distance, and an elevation angle or percentage grade. The slope distance and the elevation angle can either be typed in or measured with a hidden point measurement device.

Diagram

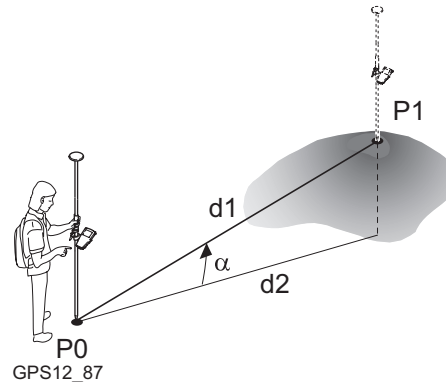

- P0 Known point
- P1 Hidden point
- d1 Slope distance
- d2 Horizontal distance
- α Elevation angle

Computing horizontal distances from slope distances step-by-step

Step	Description
1.	Refer to "46.2 Accessing Hidden Point Measurement" to access HIDDEN PT Hidden Point Measurement .
2.	HIDDEN PT Hidden Point Measurement Select <Method: Brng & Distance>, <Method: Double Distance> or <Method: Back Brng & Dist>.
3.	Highlight <Horiz Dist:>.

Step	Description
4.	SLOPE (F5) to access HIDDEN PT Slope Distance .
5.	HIDDEN PT Slope Distance <Slope Distance:> Type in a distance from the known point to the hidden point. When a hidden point measurement device is attached to the receiver to measure the distance, the value is automatically transferred.
6.	HIDDEN PT Slope Distance <Elev Angle:> Type in the elevation angle from the known point to the hidden point. When a hidden point measurement device is attached to the receiver to measure the elevation angle, the value is automatically transferred. <Grade (%):> The grade from the known point to the hidden point is automatically computed from the slope distance and the elevation angle.
	The value for <Grade (%):> can be typed in instead of the value for <Elev Angle:> . Then <Elev Angle:> is computed automatically.
7.	HIDDEN PT Slope Distance <Horiz Distance:> The horizontal distance from the known point to the hidden point is automatically computed from the slope distance and the elevation angle. <ΔHeight:> Available if using heights is configured. The height difference between the known point and the hidden point is automatically computed from the slope distance and the elevation angle.
8.	CONT (F1) to access HIDDEN PT Hidden Point Measurement .
9.	HIDDEN PT Hidden Point Measurement The horizontal distance is displayed in <Horiz Dist:> .

Step	Description
	If available, the value for ΔHeight is displayed in the HIDDEN PT Hidden Point Measurement .

46.6

Hidden Point Measurement Including Heights

Diagram

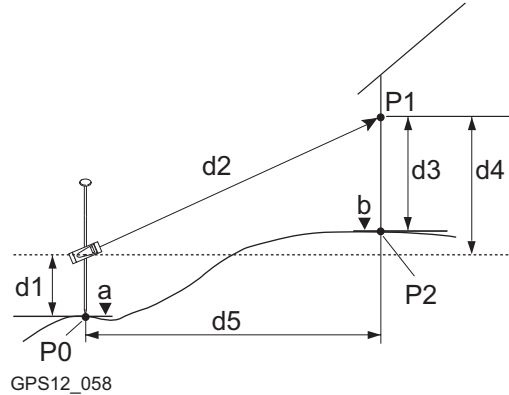

- P0 Known point
- P1 Target point
- P2 Hidden point
- a Height of P0
- b Height of P2 = $a + d1 + d4 - d3$
- d1 Device height: Height of hidden point measurement device above P0
- d2 Slope distance
- d3 Target height: Height of P1 above P2
- d4 Height difference between hidden point measurement device and P1
- d5 Horizontal distance

Configuration step-by-step

The following table explains the most common settings. Refer to the stated chapter for more information on screens.

Step	Description	Refer to chapter
1.	<Compute Ht: Yes> in CONFIGURE Hidden Point Measurement .	23.1.7
2.	<Height Offset: Device & Trgt Ht> in CONFIGURE Hidden Pt Device Offsets .	23.1.7

Hidden point measurements including heights step-by-step

The following table explains the most common settings. Refer to the stated chapter for more information on screens.

Step	Description	Refer to chapter
1.	Refer to "46.2 Accessing Hidden Point Measurement" to access HIDDEN PT Hidden Point Measurement .	
2.	<p>HIDDEN PT Hidden Point Measurement</p> <p><Method:> The hidden point measurement method. The setting determines the availability of the subsequent fields and softkeys. They are explained in previous chapters related to the individual methods.</p> <p><ΔHeight:> The positive or negative height difference between the centre of the hidden point measurement device and the target point. Type in the value. When a hidden point measurement device is attached to the receiver to measure the height difference, the value is automatically transferred.</p> <p>For hidden point measurement methods using two known points, <ΔHeight:> must be determined from each known point.</p>	46.3.1, 46.3.2, 46.3.3, 46.3.4 and 46.3.5
	<ΔHeight:> can be computed using SLOPE (F5) .	46.5
3.	HGTS (F3) to access HIDDEN PT Device & Target Height .	
4.	<p>HIDDEN PT Device & Target Height</p> <p><Device Ht at Pt A:> The height of the hidden point measurement device above <Point:> respective <Point A:>.</p>	

Step	Description	Refer to chapter
	<p><Target Ht:> The height of the target point above the hidden point when measured from <Point:> respective <Point A:>.</p> <p><Device Ht at Pt B:> Available for hidden point measurement methods using two known points. The height of the hidden point measurement device above <Point B:>.</p> <p><Target Ht:> Available for hidden point measurement methods using two known points. The height of the target point above the hidden point when measured from <Point B:>.</p>	
5.	CONT (F1) to close the screen and to return to HIDDEN PT Hidden Point Measurement .	
	<ΔHeight:> in HIDDEN PT Hidden Point Measurement still displays the positive or negative height difference between the centre of the hidden point measurement device and the target point. The height of the hidden point measurement device above the ground and the height of the target point above the hidden point are applied when the hidden point is computed.	
6.	HIDDEN PT Hidden Point Measurement	
	Continue with the hidden point measurements. Follow the instructions in the chapter relevant to the setting for <Method:> .	46.3.1, 46.3.2, 46.3.3, 46.3.4 and 46.3.5

Step	Description	Refer to chapter
	When STORE (F1) is pressed in HIDDEN PT Hidden Point Measurement , the height of the hidden point is computed and stored. For hidden point measurement methods using two known points, this is done for each known point. In this case, the height of the hidden point is the average.	

47

Survey Cross Section

47.1

Overview

Description

The Survey Cross Section application program allows for the automatic changing of codes during a survey. This is particularly useful when surveying multiple cross sections. Examples could include surveys of railway lines, roads, small waterways, driveways and paths.

The codes for the elements in the cross section to be surveyed are all stored and pre-defined in a template. The codes are then automatically changed after each point observation.

Diagram

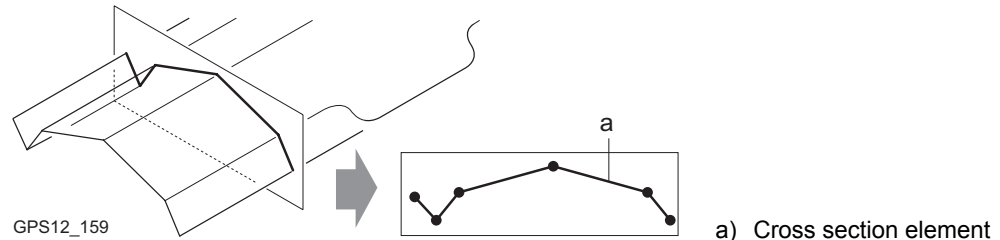

Template

Templates are used to pre-define the order of the codes for the survey.

A template pre-defines

- the coding sequence of a cross section.
- the type of coding.

Cross section methods and directions

Templates can be applied

- to the ZigZag method or the Same Direction method.
- in either a forward direction or in a backward direction.

ZigZag

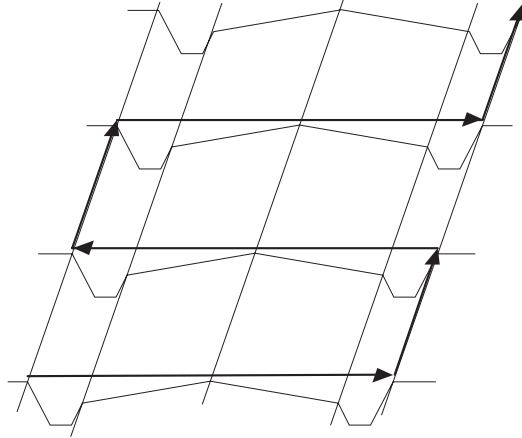

GPS12_168

Same Direction

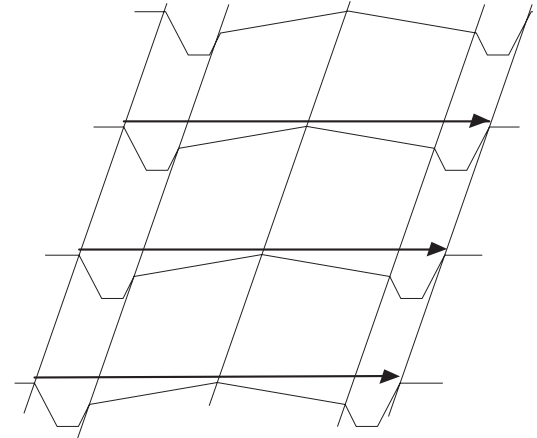

GPS12_169



Survey Cross Section is possible for **<R-Time Mode: Rover>** and **<R-Time Mode: None>**.

Coding of cross section elements	<p>Codes can be attached to cross section elements. Refer to "11 Coding" for information on coding.</p> <ul style="list-style-type: none">• Thematical coding: Available• Free coding: Available• Quick coding: Not available <p>Refer to "11.6 Code and Attribute Mismatch" for information on solving a code and/or attribute mismatch.</p>
Properties of cross section points	<p>The properties stored with cross section points are:</p> <ul style="list-style-type: none">• Class: Either MEAS or NAV depending on the position status when the element was occupied.• Sub class: GPS Fixed, GPS Code Only, GNSS Fixed, GNSS Code Only• Source: Cross Section• Instrument source: GPS
Averaging of cross section elements	<p>The principles for averaging are identical to those of the Survey application program. Refer to "9.3.4 Mean Page" for information on averaging.</p>
Exporting data	<p>The points and lines are recorded as for all other application programs. The data can be exported as normal.</p>

47.2

Accessing Survey Cross Section

Access

Select **Main Menu: Programs... \Survey Cross Section.**

OR

Press **PROG**. Highlight **Survey Cross Section. CONT (F1)**. Refer to "36.2 Accessing the Application Programs Menu" for information on the **PROG** key.

OR

Press a hot key configured to access the screen **X-SECTION Begin**. Refer to "6.1 Hot Keys" for information on hot keys.

OR

Press **USER**. Refer to "6.2 USER Key" for information on the **USER** key.

X-SECTION Begin

12:11
X-SECTION
Begin

Job : Job1

Coord System : Loca1
Code list : <None>

Config Set : RT_Rov
Antenna : AX1202 Pole

Q1a ↑
CONT CONF CSYS

CONT (F1)

To accept changes and access the subsequent screen. The chosen settings become active.

CONF (F2)

To configure Survey Cross Section application program. Accesses **X-SECTION Configuration**. Refer to "47.3 Configuring Survey Cross Section".

CSYS (F6)

To select a different coordinate system.

Description of fields

Field	Option	Description
<Job:>	Choicelist	The active job. All jobs from Main Menu: Manage...\Jobs can be selected. The templates used for a cross section survey are stored in this job.
<Coord System:>	Output	The coordinate system currently attached to the selected <Job:>.
<Codelist:>	Choicelist Output	No codes are stored in the selected <Job:>. All codelists from Main Menu: Manage...\Codelists can be selected. Codes have already been stored in the selected <Job:>. If codes had been copied from a System RAM codelist, then the name of the codelist is displayed. If codes have not been copied from a System RAM codelist but typed in manually, then the name of the active job is displayed.
<Config Set:>	Choicelist	The active configuration set. All configuration sets from Main Menu: Manage...\Configuration Sets can be selected. Configuration sets with <R-Time Mode: Reference> cannot be used in the Survey Cross Section application program.
<Antenna:>	Choicelist	The antenna currently defined to be used in the selected configuration set. All antennas from Main Menu: Manage...\Antennas can be selected.

Next step

IF the Survey Cross Section application program	THEN
is to be accessed	CONT (F1) accepts the changes and accesses Survey Cross Section application program. Refer to "47.4 Surveying Cross Sections".
is to be configured	CONF (F2) . Refer to "47.3 Configuring Survey Cross Section".

47.3

Configuring Survey Cross Section

Access

Select **Main Menu: Programs...\Survey Cross Section**. In **X-SECTION Begin** press **CONF (F2)** to access **X-SECTION Configuration**.

OR

Press **PROG**. Highlight **Survey Cross Section**. **CONT (F1)**. In **X-SECTION Begin** press **CONF (F2)** to access **X-SECTION Configuration**.

OR

Press **SHIFT CONF (F2)** in **X-SECTION Survey: Job Name**.

**X-SECTION
Configuration,
General page**

11:38

X-SECTION Configuration

General

Method : ZigZag

Direction : Forward

Show Attrib : 1

Show Dist : Yes

Display Mask : <None>

CONT

CONT (F1)

To accept changes and return to the screen from where this screen was accessed.

DMASK (F3)

To edit the display mask currently being displayed in this field. Accesses **CONFIGURE Define Display Mask n**. Available for **<Display Mask:>** being highlighted on **General** page. Refer to "19.2 Display Settings".

SHIFT ABOUT (F5)

To display information about the program name, the version number, the date of the version, the copyright and the article number.

Description of fields

Field	Option	Description
<Method:>	<p>ZigZag</p> <p>Same Direction</p>	<p>Method by which subsequent cross sections will be surveyed. Refer to "47.1 Overview" for a diagram.</p> <p>Each new cross section is started at the same end as where the previous cross section finished.</p> <p>Each new cross section is started at the same end as where the previous cross section started.</p>
<Direction:>	<p>Forward</p> <p>Backward</p>	<p>The way of surveying the cross section. This influences in which order the elements of a template will be applied. Refer to "47.1 Overview" for a diagram.</p> <p>The cross sections will be surveyed in the same way as the elements are defined in the selected <Template:> in X-SECTION Survey: Job Name.</p> <p>The cross sections will be surveyed in the reverse way as the elements are defined in the selected <Template:> in X-SECTION Survey: Job Name.</p>
<Show Attrib:>	<p>Do Not Show</p>	<p>Defines which attribute field is displayed in X-SECTION Survey: Job Name. Useful if the surveyor is stringing - can then see that the correct string attribute value is being used.</p> <p>No attribute field is displayed in X-SECTION Survey: Job Name.</p>

Field	Option	Description
	From 1 to 20	The attribute field which is displayed in X-SECTION Survey: Job Name .
<Show Dist:>	Yes or No	Activates an output field in X-SECTION Survey: Job Name . The horizontal grid distance from the current position to the point last surveyed for the same cross section will be displayed.
<Display Mask:>	Choicelist	The user defined display mask is shown in X-SECTION Survey: Job Name . All display masks of the active configuration set defined in CONFIGURE Display Settings can be selected.

Next step

CONT (F1) returns to the screen from where this screen was accessed.

47.4

Surveying Cross Sections

Description

The fields on this screen indicate which cross section element is to be surveyed next.

Access step-by-step

Step	Description
1.	Refer to "47.2 Accessing Survey Cross Section" to access X-SECTION Begin .
2.	In X-SECTION Begin select a job.
3.	Select a configuration set with <R-Time Mode: None> or <R-Time Mode: Rover> .
4.	Select an antenna.
5.	CONT (F1) to access X-SECTION Survey: Job Name, General page .

X-SECTION

Survey: Job Name, General page

The pages shown are those from a typical configuration set. An additional page is available when a user defined display mask is used.

11:59
X-SECTION
Survey: Job1
General | Map
Point ID : 802
Antenna Ht : 2.000 m
Template : 001
Element : 1/3
Code : TOE
Dist to Last : ----- m
OCUPY START SURVY PAGE

OCUPY (F1)

To start measuring the next point of the cross section. The position mode icon changes to the static icon. **(F1)** changes to **STOP**.

Available if a template has been opened with **START (F4)**.

STOP (F1)

To end measuring the point. When **<Auto STOP: Yes>** in **CONFIGURE Point Occupation Settings**, recording of positions ends automatically as defined by the stop criteria. The position mode icon changes to the moving icon. **(F1)** changes to **STORE**.

STORE (F1)

To store the measured point. When **<Auto STORE: Yes>** in **CONFIGURE Point Occupation Settings**, the measured point is stored automatically. **(F1)** changes to **OCCUPY**.

START (F4) and END (F4)

To open and close the selected cross section template. While the template is open, the elements of the cross section can be surveyed.

SURVY (F5)

To manually occupy a point that is not part of the cross section. The point is not treated as an element of the cross section. The open template remains open.

Available if a template has been opened with **START (F4)**.

PAGE (F6)

To change to another page on this screen.

SHIFT CONF (F2)

To configure the Cross Section Survey application program. Refer to "47.3 Configuring Survey Cross Section".

SHIFT PREV (F3)

To select the previous element of the cross section template. The currently measured element will not be stored.

Available for **STOP (F4)** being displayed.

SHIFT NEXT (F4)

To select the next element of the cross section template. The currently measured element will not be stored.

Available for **STOP (F4)** being displayed.

SHIFT INDIV (F5) and SHIFT RUN (F5)

To change between entering an individual point ID different to the defined ID template and the running point ID according to the ID template. Refer to "19.1 ID Templates".

SHIFT QUIT (F6)

To exit Cross Section Survey application program. An open template will be closed.

Description of fields

Field	Option	Description
<Point ID:>	User input	<p>The identifier for manually occupied points. The configured point ID template is used. The ID can be changed in the following ways:</p> <ul style="list-style-type: none"> To start a new sequence of point ID's type over the point ID.

Field	Option	Description
		<ul style="list-style-type: none"> For an individual point ID independent of the ID template SHIFT INDIV (F5). SHIFT RUN (F5) changes back to the next ID from the configured ID template. Refer to "19.1 ID Templates".
<Antenna Ht:>	User input	The default antenna height as defined in the active configuration set is suggested. Refer to "2 Antenna Heights". Changing the antenna height here does not update the default antenna height as defined in the active configuration set. The changed antenna height is used until the application program is exited.
<Template:>	<p>Choicelist</p> <p>Output</p>	<p>The active template for the cross section.</p> <p>The cross section template is closed.</p> <p>Opening the choicelist accesses X-SECTION Templates where a new template can be created and an existing template can be selected or deleted. Refer to "47.5 Cross Section Templates".</p> <p>---- is displayed if no template is defined.</p> <p>The cross section template is open.</p>
<Element:>	Output	<p>Displayed as x/y.</p> <p>x Number of next element on active template. The number increases/decreases as moving across the cross section depending on the selection for <Method:> in X-SECTION Configuration.</p> <p>y Total number of elements on active template.</p>

Field	Option	Description
<Code:>	Output	The name of the code. Point codes will be stored with the measured point. Free codes will be stored, depending on the configuration, before or after the measured point.
<Stringline ID:>	Output	Available for <String Attrib:> being activated in CONFIGURE Coding & Linework, Coding page. Points that have the same code attached and belong to different cross sections are strung to one line.
<Dist to Last:>	Output	The horizontal grid distance from the current position to the last surveyed point. ----- is displayed for unavailable information.

Next step

IF	THEN
a cross section template is to be opened	select the desired <Template:>. START (F4) .
an element of a cross section is to be surveyed	OCUPY (F1), STOP (F1) and then STORE (F1) .  Once the end of a cross section is surveyed then the next cross section will be measured. Depending on the selection this is either in the same direction or in ZigZag mode.
a cross section template is to be closed	select the desired <Template:>. END (F4) .

IF	THEN
data is to be viewed graphically	PAGE (F6) . Refer to paragraph "X-SECTION Survey: Job Name, Map page".
the screen is to be quit	ESC .

**X-SECTION
Survey: Job Name,
Map page**

The **Map** page provides an interactive display of the data. Refer to "32 MapView Interactive Display Feature" for information on the functionality and softkeys available. An element of a cross section template can also be surveyed from the **Map** page.

Next step

PAGE (F6) changes to the first page on this screen.

47.5

47.5.1

Cross Section Templates

Accessing Cross Section Template Management

Description

Cross section templates

- pre-define the sequence of codes for a cross section.
- consist of elements.

Elements can be defined such that the surveyed points of a cross section are

- stored with a point code.
- stored with a free code.

During the process of surveying a cross section, the code for the next element to be occupied is then selected and suggested automatically.

Access step-by-step

Step	Description
1.	Refer to "47.4 Surveying Cross Sections" to access X-SECTION Survey: Job Name .
2.	X-SECTION Survey: Job Name, General page Open the choicelist for <Template:> .

X-SECTION Templates

All cross section templates stored in the active job are listed in alphabetical order, including the number of elements in each cross section template.

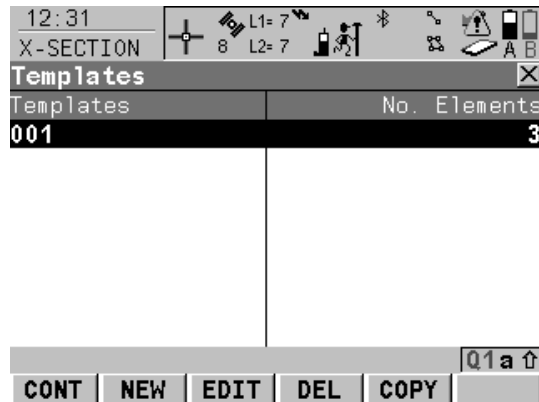

CONT (F1)

To select the highlighted cross section template and to return to the screen from where this screen was accessed.

NEW (F2)

To create a cross section template. Refer to "47.5.2 Creating a New Cross Section Template".

EDIT (F3)

To edit the highlighted cross section template. Refer to "47.5.3 Editing a Cross Section Template".

DEL (F4)

To delete the highlighted cross section template.

COPY (F5)

To create a cross section template based on the one currently highlighted.

Next step

IF a cross section template	THEN
is to be selected	highlight the desired cross section template. CONT (F1) closes the screen and returns to the screen from where X-SECTION Templates was accessed.
is to be created	NEW (F2) . Refer to "47.5.2 Creating a New Cross Section Template".
is to be edited	highlight the cross section template and EDIT (F3) . Refer to "47.5.3 Editing a Cross Section Template".
is to be created based on an existing template	COPY (F5) . Refer to "47.5.2 Creating a New Cross Section Template".

47.5.2

Creating a New Cross Section Template

Access

Step	Description
1.	Open the choicelist for <Template:> in X-SECTION Survey: Job Name, General page .
2.	<p>X-SECTION Templates</p> <p>Is a cross section template to be created from scratch?</p> <ul style="list-style-type: none"> • If yes, NEW (F2) to access X-SECTION New Template. • If no, COPY (F5) to access X-SECTION New Template.

**X-SECTION
New Template,
General page**

Type in a name for the new cross section template.

Next step

PAGE (F6) changes to the **Elements** page. Refer to paragraph "X-SECTION New Template, Elements page".

**X-SECTION
New Template,
Elements page**

IF this screen was accessed with	THEN
NEW (F2)	all columns are empty.
COPY (F5)	the same elements are listed as were being used for the template highlighted when COPY (F5) was pressed.

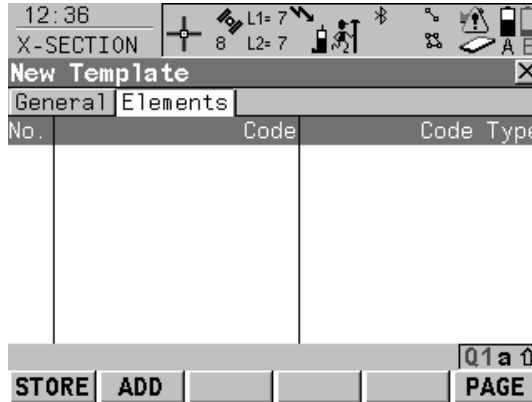

STORE (F1)

To store the cross section template and to return to the screen from where this screen was accessed.

ADD (F2)

To add one or several element(s) to the cross section template. Refer to paragraph "X-SECTION Add Element".

EDIT (F3)

To edit the highlighted element. Refer to paragraph "X-SECTION Add Element".

DEL (F4)

To delete the highlighted element from the cross section template.

->ADD (F5)

To insert one element before the currently highlighted element of the cross section template. Refer to paragraph "X-SECTION Add Element".

PAGE (F6)

To change to another page on this screen.

Description of columns

Field	Description
No.	The number of the element.

Field	Description
Code	The code assigned to the element. ---- is displayed if no code is assigned to the element.
Code Type	The type of the code assigned to the element.

Next step

IF	THEN
the creation of a template is finished	STORE (F1).
an element is to be added	ADD (F2) or ->ADD (F5). Refer to paragraph "X-SECTION Add Element".
an element is to be edited	EDIT (F3). Refer to paragraph "X-SECTION Add Element".

X-SECTION Add Element

The functionality of the screens **X-SECTION Insert Element** and **X-SECTION Edit Element in Template** is very similar. Differences to **X-SECTION Add Element** are outlined below.

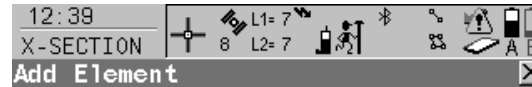

Element No. : 4

Code Type : **Thematic Codes**

Code : **TOE**

Code Desc : **Bottom of Bank**



CONT (F1)

To add the element at the end of the cross section template or to store the changes.

To return to the screen from where this screen was accessed.

NEXT (F5)

Available in **X-SECTION Add Element**.

To add the element at the end of the cross section template. To stay in this screen and create the next element.

PREV (F5)

Available in **X-SECTION Edit Element in Template**.

To store the changes. To stay in this screen and edit the previous element.

NEXT (F6)

Available in **X-SECTION Edit Element in Template**.

To store the changes. To stay in this screen and add the next element.

Description of columns

Field	Option	Description
<Element No.:>	Output	For X-SECTION Add Element and X-SECTION Insert Element : The number of the element to be added. For X-SECTION Edit Element in Template : Displayed as x/y. x Number of the element to be edited. y Total number of elements on the active template.
<Code Type:>	Free Code Thematic Codes	The type of code to be used with the element. To store a code independent of the element as time related information. To store a code together with the element.
<Rec Free Code:>	After Point or Before Point	Available for <Code Type: Free Code> . Determines if a free code is stored before or after the point.
<Code (free):>	Choicelist	The code which will be stored before or after the point/line. Available for <Code Type: Free Code> .
<Code:>	Choicelist	The code which will be stored with the next point/line. Available for <Code Type: Thematic Codes> .

Field	Option	Description
Attribute name	Output	The attribute and the attribute value which will be stored with the point/line. Available unless <Show Attrib: Do Not Show> in X-SECTION Configuration .

Next step

CONT (F1) adds the element or stores the changes and returns to **X-SECTION New Template, Elements** page.

47.5.3**Editing a Cross Section Template****Access**

Refer to "47.2 Accessing Survey Cross Section" to access **X-SECTION Templates**.

**Edit cross section
template step-by-step**

Step	Description
1.	In X-SECTION Templates highlight the cross section template to be edited.
2.	EDIT (F3) to access X-SECTION Edit Template, General page.
3.	X-SECTION Edit Template All the following steps are identical with the creation of a new cross section template. Refer to "47.5.2 Creating a New Cross Section Template".

47.6

Working Example

Description

Application:	Surveying a road, taking the same cross sections at particular intervals.
Working technique:	Real-time kinematic.
Goal:	The points of each cross section are to be picked up. Codes are assigned automatically. The codes are shown in the diagram. Each new cross section is started at the same end as where the previous cross section finished.

Diagram

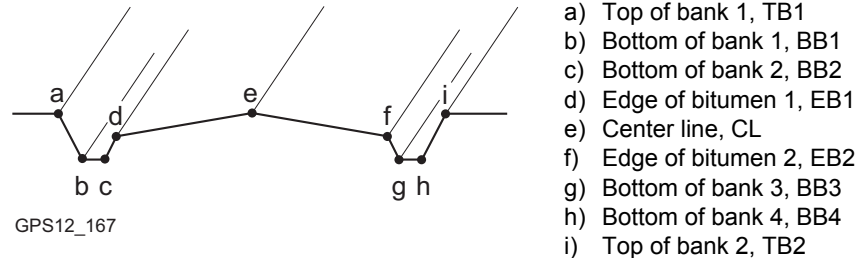

Requirements



- A real-time reference is running.
- For the rover: **<R-Time Mode: Rover>** in **CONFIGURE Real-Time Mode**.
- A codelist containing the codes TB1, BB1, BB2, EB1, CL, EB2, BB3, BB4 and TB2 has been created in LGO and loaded onto the receiver.

Field procedure step-by-step

The following table explains the most common settings. Refer to the stated chapter for more information on screens.

Step	Description	Refer to chapter
1.	Set up all equipment as for a real-time operation.	1
2.	Start the Survey Cross Section application program.	47.2
3.	X-SECTION Begin <Codelist:> The codelist containing the point codes TB1, BB1, BB2, EB1, CL, EB2, BB3, BB4 and TB2 must be displayed. Check the settings.	47.2 10.3
4.	CONF (F2)	
5.	X-SECTION Configuration <Method: ZigZag> <Direction: Forward> <Show Dist: Yes>	47.3
6.	CONT (F1)	
7.	Have cross section templates been defined yet? <ul style="list-style-type: none"> • If yes, continue with step 19. • If no, continue with step 8. 	
8.	OK (F4) to confirm the information message and to access X-SECTION New Template .	
9.	X-SECTION New Template, General page	47.5.2

Step	Description	Refer to chapter
	<Template Name:> Type in a name for the new cross section template.	
10.	PAGE (F6) to access X-SECTION New Template, Elements page	
11.	ADD (F2) to access X-SECTION Add Element .	
12.	X-SECTION Add Element <Code Type: Thematic Codes> <Code: TB1>	47.5.2
13.	NEXT (F5) adds the element to the cross section template and stays in this screen to create the next element.	
14.	Repeat steps 12. and 13. for the next seven elements.	
15.	Repeat step 12. for the last element.	
16.	CONT (F1) to add the element to the cross section template and to return to X-SECTION New Template .	
17.	STORE (F1) to store the new cross section template and to return to X-SECTION Templates .	
18.	X-SECTION Templates The newly created template is highlighted.	
19.	CONT (F1) to access X-SECTION Survey: Job Name .	
20.	X-SECTION Survey: Job Name <Element: 1/5>	47.4

Step	Description	Refer to chapter
	<Code: TB1>	
	Open the choicelist for <Templates:> to create a new cross section template or to select or delete an existing template.	
21.	START (F4) to open the template.	
22.	Go to the beginning of the first cross section.	
23.	OCUPY (F1) to start the point occupation.	
24.	STOP (F1) to stop the point occupation	
25.	STORE (F1) to store the element.	
26.	Repeat steps 23. to 25. for the remaining four elements.	
27.	Go to the position for the next cross section. <Dist To Last:> displays the interval.	
	Since working in ZigZag mode, the next cross section starts "at the end", this means with TB2.	
28.	Continue until all cross sections are surveyed.	
29.	END (F4) to close the template.	
30.	SHIFT QUIT (F6) to quit the screen.	

48

Volume Calculations

48.1

Overview

Description

The Volume Calculations application program allows surfaces to be measured and volumes (and other information) to be computed from these surfaces.

Volume calculations tasks

The Volume calculations application program can be used for the following tasks:

- Measuring points (surface points and boundary points) defining a new surface or extending existing surfaces from the active job.
- Calculating the triangulation of the measured surface points to establish the surface.
- Calculating volumes from a reference (3D point, entered elevation) or by a stockpile method.

The surface calculation can be made from

- existing point data in the job.
- manually occupied points.
- entered coordinates.

Activating the application program

The Volume Calculations application program must be activated via a licence key. Refer to "30 Tools...\Licence Keys" for information on how to activate the application program.



Volume Calculations is possible for **<R-Time Mode: Rover>** and **<R-Time Mode: None>**.

Point types

Surfaces can be created from points stored as:

- Local grid
- Height mode can be ellipsoidal or orthometric.

Heights and positions are always taken into account. Points must have full coordinate triplets.

Properties of measured points

The properties stored with measured points are:

- Class: Either **MEAS** or **NAV** depending on the position status when the point was occupied.
 - Sub class: **GPS Fixed**, **GPS Code Only**, **GNSS Fixed**, **GNSS Code Only**
 - Instrument source: **GPS**
-

48.2

Accessing Volumes Calculations

Access

Select **Main Menu: Programs...\Volume Calculations.**

OR

Press **PROG**. Highlight **Volume Calculations**. **CONT (F1)**. Refer to "36.2 Accessing the Application Programs Menu" for information on the **PROG** key.

OR

Press a hot key configured to access the screen **VOLUMES Volume Calculations Begin**. Refer to "6.1 Hot Keys" for information on hot keys.

OR

Press **USER**. Refer to "6.2 USER Key" for information on the **USER** key.

VOLUMES
Volume Calculations
Begin

19:11
 VOLUMES
 Volume Calculations Begin

Job : Job1

Coord System : Local

Codelist : <None>

Config Set : RTK Rover

Antenna : AX1202 Pole

CONT CONF CSYS

CONT (F1)

To accept changes and access the subsequent screen. The chosen settings become active.

CONF (F2)

To configure Volume Calculations application program. Accesses **VOLUMES Configuration**. Refer to "48.3 Configuring Volume Calculations".

CSYS (F6)

To select a different coordinate system.

Description of fields

Field	Option	Description
<Job:>	Choicelist	The active job. All jobs from Main Menu: Manage...\Jobs can be selected.
<Coord System:>	Output	The coordinate system currently attached to the selected <Job:>.
<Codelist:>	Choicelist	No codes are stored in the selected <Job:>. All codelists from Main Menu: Manage...\Codelists can be selected.
	Output	Codes have already been stored in the selected <Job:>. If codes had been copied from a System RAM codelist, then the name of the codelist is displayed. If codes have not been copied from a System RAM codelist but typed in manually, then the name of the active job is displayed.
<Config Set:>	Choicelist	The active configuration set. All configuration sets from Main Menu: Manage...\Configuration Sets can be selected. Configuration sets with <R-Time Mode: Reference> cannot be used in the Volume Calculations application program.
<Antenna:>	Choicelist	The antenna currently defined to be used in the selected configuration set. All antennas from Main Menu: Manage...\Antennas can be selected.

**VOLUMES
Volume Calculations
Menu**

Next step

CONT (F1) accepts changes and accesses **VOLUMES Volume Calculations Menu**.

The **VOLUMES Volume Calculations Menu** lists all Volume Calculations steps and the option to end Volume Calculations.

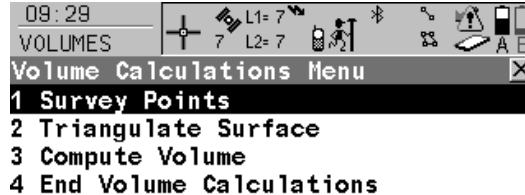

CONT (F1)

To select the highlighted option and to continue with the subsequent screen.

SHIFT CONF (F2)

To configure the Volume Calculations application program. Accesses **VOLUMES Configuration**. Refer to "48.3 Configuring Volume Calculations".



Description of the Volume calculations menu options

Volume Calculations menu options	Description	Refer to chapter
Survey Points	To measure points defining a new surface or extending existing surfaces currently stored in the active job.	48.4.1
Triangulate Surface	To triangulate (delauny triangulation) the measured surface points to establish the surface.	48.4.2

Volume Calculations menu options	Description	Refer to chapter
Compute Volume	To compute the volume of a surface by a reference (3D point, entered elevation) or by the stockpile method.	48.4.3
End Volume Calculations	To end Volume Calculations and return to the screen from where Volume Calculations was accessed.	

Next step

IF	THEN
a Volume Calculations method is to be started	highlight the relevant option and press CONT (F1) . Refer to the chapters stated above.
Volume Calculations is to be configured	SHIFT CONF (F2) . Refer to "48.3 Configuring Volume Calculations".
Volume Calculations is to be ended	highlight End Volume Calculations and CONT (F1) .

48.3

Configuring Volume Calculations

Access

Select **Main Menu: Programs...Volume Calculations**. In **VOLUMES Volume Calculations Begin** press **CONF (F2)** to access **VOLUMES Configuration**.

OR

Press **PROG**. Highlight **Volume Calculations**. **CONT (F1)**. In **VOLUMES Volume Calculations Begin** press **CONF (F2)** to access **VOLUMES Configuration**.

OR

Press **SHIFT CONF (F2)** in **Volume Calculations XX VOLUMES**.

VOLUMES Configuration, Logfile page

The screenshot shows the VOLUMES Configuration screen. At the top, the time is 19:11. Below the title bar, there are status icons for signal strength, L1=8, L2=8, a person icon, a Bluetooth icon, a Wi-Fi icon, a battery icon, and a signal strength icon. The main content area shows the word "Configuration" in a dark bar. Below that, the text "Logfile" is followed by a greyed-out input field. The "Write Logfile:" option is set to "Yes" with left and right arrow keys. The "File Name" is "logfile.txt" with left and right arrow keys. The "Format File" option is followed by left and right arrow keys.

The screenshot shows the bottom navigation bar of the VOLUMES Configuration screen. It consists of five buttons. The first button is labeled "CONT". The second button is empty. The third button is empty. The fourth button is empty. The fifth button is labeled "a" with an upward arrow icon.

CONT (F1)

To accept changes and return to the screen from where this screen was accessed.

SHIFT ABOUT (F5)

To display information about the program name, the version number, the date of the version, the copyright and the article number.

Description of fields

Field	Option	Description
<Write Logfile:>	Yes or No	To generate a logfile when the application program is exited.
		A logfile is a file to which data from an application program is written to. It is generated using the selected <Format File:>.
<File Name:>	Choicelist	Available for <Write Logfile: Yes>. The name of the file to which the data should be written. A logfile is stored in the \DATA directory of the active memory device. The data is always appended to the file. Opening the choicelist accesses XX Logfiles where a name for a new logfile can be created and an existing logfile can be selected or deleted.
<Format File:>	Choicelist	Available for <Write Logfile: Yes>. A format file defines which and how data is written to a logfile. Format files are created using LGO. A format file must first be transferred from the CompactFlash card to the System RAM before it can be selected. Refer to "26 Tools...\Transfer Objects..." for information on how to transfer a format file. Opening the choicelist accesses XX Format Files where an existing format file can be selected or deleted.

Next step

CONT (F1) returns to the screen from where this screen was accessed.

48.4

Calculating Volumes

48.4.1

Survey Points

Description

To measure points to a new surface or a surface existing in the active job. If no surfaces currently exist in the active job, the user have to create a **New Surface** first in **VOLUMES Choose Task & Surface** before measuring points to this **New Surface**. The menu items **Triangulate Surface** and **Compute Volume** within the **VOLUMES Volumes & Surfaces Menu** are marked grey if no surface exists in the active job.

Access

Refer to "48.2 Accessing Volumes Calculations" to access **VOLUMES Surface Points**.

VOLUMES Surface Points, Survey page

The pages shown are those from a typical configuration set. An additional page is available when a user defined display mask is used.

09:32		L1= 7		L2= 7		A	
VOLUMES		+		7		7	
Surface Points (ESC when done) X							
Survey		Code		Annot		Map	
Point ID		:		138			
Antenna Ht		:		2.000		m	
3D CQ		:		0.010		m	
				A		↑	
OCUPY		NEAR		>BNDY		H PNT PAGE	

OCUPY (F1)

To start measuring the surface point. (F1) changes to **STOP**.

STOP (F1)

To end measuring the surface point. When **<Auto STOP: Yes>** in **CONFIGURE Point Occupation Settings**, recording of positions ends automatically as defined by the stop criteria. The position mode icon changes to the moving icon. (F1) changes to **STORE**.

STORE (F1)

To store the measured surface point. When **<Auto STORE: Yes>** in **CONFIGURE Point Occupation Settings**, the measured surface point is stored automatically. **(F1)** changes to **OCUPY**.

NEAR (F2)

To search **<Volumes Job:>** for the point nearest to the current position when the key is pressed. The point is selected as the point to be measured and is displayed in the first field on the screen. After measuring and storing the nearest point, the next point suggested is the one which was suggested before the key was pressed.

Available when **OCUPY (F1)** is displayed.

>BNDY (F3) / >SURF (F3)

To change the class of the point to be measured between surface point and boundary point.

H PNT (F5)

To calculate hidden points which may be needed during triangulating the surface. To return to Volume calculations application program, press **SHIFT QUIT (F6)** or **ESC**.

Available for **OCUPY (F1)** being displayed.

PAGE (F6)

To change to another page on this screen.

SHIFT CONEC (F3) and SHIFT DISCO (F3)

To dial the number of the reference station configured in the active configuration set and to hang up immediately after the survey is completed. Available for **OCUPY (F1)** or **STORE (F1)** being displayed and for real-time devices of type digital cellular phone or modem. Available for **<Auto CONEC: No>** in **CONFIGURE GSM Connection**.

SHIFT INIT (F4)

To select an initialisation method and to force a new initialisation. Available for **OCUPY (F1)** or **STORE (F1)** being displayed and for configuration sets allowing phase fixed solutions. Refer to "44.6.2 Accessing Initialisation for Real-Time Rover Operations".

SHIFT INDIV (F5) and SHIFT RUN (F5)

To change between entering an individual point ID different to the defined ID template and the running point ID according to the ID template. Refer to "19.1 ID Templates".

SHIFT QUIT (F6)

To exit Volumes calculations application program. Available for **OCUPY (F1)** being displayed.

Description of fields

Field	Option	Description
<Point ID:>	User input	<p>The identifier for manually occupied points. The configured point ID template is used. The ID can be changed in the following ways:</p> <p>To start a new sequence of point ID's type over the point ID.</p> <p>For an individual point ID independent of the ID template SHIFT INDIV (F5). SHIFT RUN (F5) changes back to the next ID from the configured ID template. Refer to "19.1 ID Templates".</p>
<Antenna Ht:>	User input	<p>The default antenna height as defined in the active configuration set is suggested. Refer to "2 Antenna Heights". Changing the antenna height here does not update the default antenna height as defined in the active configuration set. The changed antenna height is used until the application program is exited.</p>
<3D CQ:>	Output	<p>The current 3D coordinate quality of the computed position.</p>

Next step

ESC returns to **VOLUMES Choose Task & Surface** screen.

ESC again to return to **VOLUMES Volume Calculations Menu** from where this screen was accessed.

48.4.2 Triangulate Surfaces

Description

To calculate the triangulation (triangulation method: delauny) of the measured surface points to establish the surface.

Access

Refer to "48.2 Accessing Volumes Calculations" to access **VOLUMES Triangulate Surface**.

VOLUMES Triangulate Surface, General page

09:30
VOLUMES
Triangulate Surface
General | Points | Map
Surface Name : S1
No. Surf Pts : 93
No. Bndy Pts : 33
Last Pt ID : 1000
Last Pt Date : 29.03.06
Last Pt Time : 12:24:29
CONT PAGE A ↑

CONT (F1)

To access **VOLUMES Boundary Definition**. (F1) changes to **CALC**.

PAGE (F6)

To change to another page on this screen.

SHIFT CONF (F2)

To access **VOLUMES Configuration**. Refer to "48.3 Configuring Volume Calculations".

SHIFT DEL S (F4)

To delete the surface.

Description of fields

Field	Option	Description
<Surface Name:>	Choicelist	Name of the surface to be triangulated.
<No. Surf Pts:>	Output	Number of the measured surface points.
<No. Bndy Pts:>	Output	Number of the measured boundary points.

Field	Option	Description
<Last Pt ID:>	Output	ID of the last measured point of the chosen surface.
<Last Pt Date:>	Output	Date of the last measured point of the chosen surface.
<Last Pt Time:>	Output	Time of the last measured point of the chosen surface.

Next step

CONT (F1) continues to **VOLUMES Boundary Definition**.

VOLUMES Boundary Definition, Points page

Point ID	Height
1044	1641.070
1000	1641.550
1001	1641.060
1007	1640.610
1008	1640.260
1009	1640.870
1010	1641.310

CALC (F1)

To start calculating the triangulation and to access to the **VOLUMES Triangulation Results**.

ADD 1 (F2)

To add points from the active job to the surface.

UP (F3)

To move the focused point one step up within the boundary definition.

DOWN (F4)

To move the focused point one step down within the boundary definition.

MORE (F5)

To display information about the code group, the code type, the code description and the quick codes if available.

PAGE (F6)

To change to another page on this screen.

SHIFT HOME (F2)

To move the focus to the top of the points list.

SHIFT END (F3)

To move the focus to the bottom of the points list.

SHIFT REM 1 (F4)

To remove the marked point from the surface.

SHIFT EXTRA (F5)

To access to the **VOLUMES Extra Menu**.

Next step

SHIFT (F5) continues to **VOLUMES Extra Menu**. Refer to "VOLUMES Extra Menu".

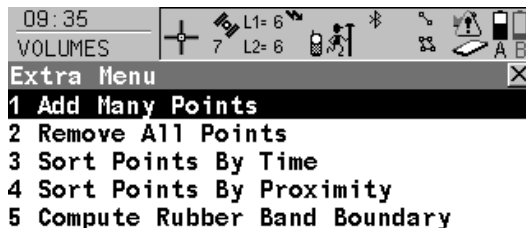
**VOLUMES
Extra Menu****CONT (F1)**

To enter the highlighted option from the **VOLUMES Extra Menu**.

Description of fields

Field	Description
<Add Many Points>	Access Data Manage and all points that are in the list.
<Remove All Points>	Method to remove all points that are indicated in the Boundary Definition points page.
<Sort Points by Time>	Method to sort all points in the Boundary Definition points page by the time they were stored.
<Sort Points by Proximity>	Method to sort all points in the Boundary Definition points page by the closest proximity.
<Compute Rubber Band Boundary>	Method to define a new boundary as if a rubber band was placed around the points. The current list of boundary points will be ignored.

Next step

CONT (F1) returns to the screen. **CALC (F1)** calculates the triangulation and continues to **VOLUMES Triangulation Results**.

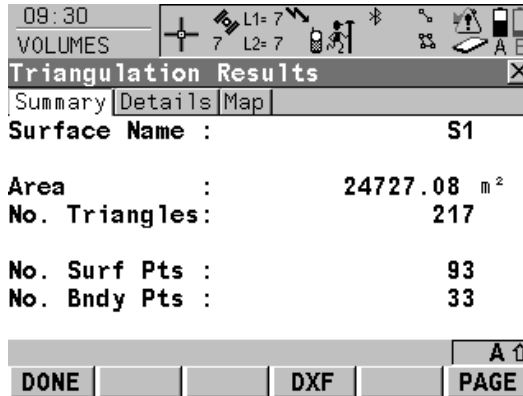
VOLUMES**Triangulation Results,
Summary page****DONE (F1)**

To close the triangulation of the surface and return to **Volumes Calculations Menu**.

DXF (F4)

To export the triangulation results to a DXF file on the data or root directory of the CF Card.

PAGE (F6)

To change to another page on this screen.

SHIFT CONF (F2)

Accesses the **VOLUMES Configuration**. Refer to "48.3 Configuring Volume Calculations".

Description of fields

Field	Option	Description
<Surface Name:>	Output	Name of the surface.
<Area:>	Output	Area of the base plane.
<No. Triangles:>	Output	Number of triangles used within the triangulation.
<No. Surf Pts:>	Output	Number of points inside the surface.
<No. Bndy Pts:>	Output	Number of boundary points of the surface.

Next step

PAGE (F6) changes to the **Details** page. Refer to "VOLUMES Triangulation Results, Details page".

**VOLUMES
Triangulation Results,
Details page**

Description of fields

Field	Option	Description
<No. Points:>	Output	Total number of points from the surface.
<Min Elevation:>	Output	Minimal elevation of the triangulated surface.
<Max Elevation:>	Output	Maximal elevation of the triangulated surface.
<Longest Side:>	Output	Value of the longest triangle side.
<Area (3D):>	Output	Surface area (3D).

Next step

PAGE (F6) changes to the **Map** page. Refer to "VOLUMES Triangulation Results, Map page".

**VOLUMES
Triangulation Results,
Map page**

The **Map** page provides an interactive display of the data. Refer to "32 MapView Interactive Display Feature" for information on the functionality and softkeys available.

Next step

DONE (F1) returns to **Volume Calculation Menu** page. Refer to "VOLUMES Volume Calculations Menu".

48.4.3

Compute Volumes

Description

To compute the volume of an triangulated surface by using a reference (3D point or elevation) or the stockpile method.

Access

Refer to "48.2 Accessing Volumes Calculations" to access **VOLUMES Compute Volume**.

VOLUMES

Compute Volume

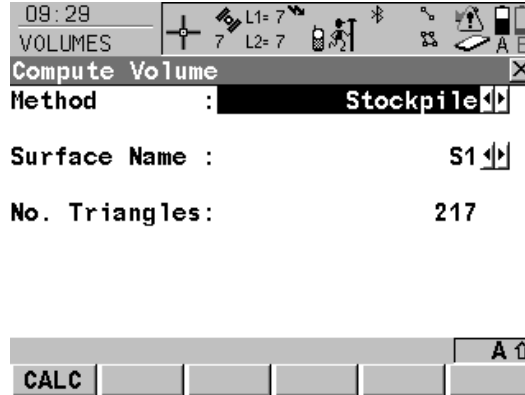

CALC (F1)

Computing the volume and access to the **VOLUMES Volume Calculation Results** page. (F1) changes to **CONT**.

SHIFT CONF (F2)

To access **VOLUMES Configuration**. Refer to "48.3 Configuring Volume Calculations".

Description of fields

Field	Option	Description
<Method:>	Choicelist	To calculate the volume of the triangulated surface using

Field	Option	Description
		<ul style="list-style-type: none"> • Stockpile (volume between the triangulated surface and the plane defined by the boundary points of the surface). • Surface to Elev (volume between the triangulated surface and the height entered by the user). • Surface to Point (volume between the triangulated surface and the height of a selected point).
<Surface Name:>	Choicelist	Surface chosen from the triangulated surfaces currently stored to the active job.
<No. Triangles:>	Output	Number of triangles from the triangulation of the surface.

Next step

CALC (F1) calculates the volume and continues to **VOLUMES Volume Calculation Results**.

VOLUMES

Volume Calculation

Results, Summary page

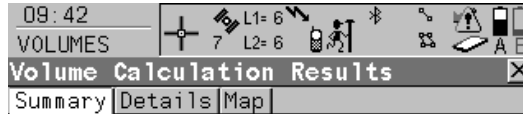

Surface Name : S1

Area : 24727.08 m²

Net Volume : 228439.47 m³



CONT (F1)

Computing the volume and access to the **VOLUMES Volume Calculation Results** page. (F1) changes to **CONT**.

PAGE (F6)

To change to another page on this screen.

SHIFT CONF (F2)

To access **VOLUMES Configuration**. Refer to "48.3 Configuring Volume Calculations".

Description of fields

Field	Option	Description
<Surface Name:>	Output	Surface.
<Area:>	Output	Area of the base plane.
<Net Volume:>	Output	Volume of the surface.

Next step

PAGE (F6) changes to the **Details** page. Refer to "VOLUMES Volume Calculation Results, Details page".

VOLUMES

Volume Calculation Results, Details page

Description of fields

Field	Option	Description
<Min Elevation:>	Output	Minimal elevation of the calculated volume.
<Max Elevation:>	Output	Maximal elevation of the calculated volume.
<Avg Thickness:>	Output	Average thickness of the calculated volume.
<Perimeter:>	Output	Perimeter of the measured surface area (intersection of the measured surface to the reference datum).

Next step

PAGE (F6) changes to the **Map** page. Refer to "VOLUMES Triangulation Results, Map page".

VOLUMES

Volume Calculation Results, Map page

The **Map** page provides an interactive display of the data. Refer to "32 MapView Interactive Display Feature" for information on the functionality and softkeys available.

Next step

CONT (F1) returns to **Volume Calculation Menu** page. Refer to "VOLUMES Volume Calculations Menu".

49

Wake-Up

49.1

Overview

Description

Wake-up sessions are static point occupations

- for which the receiver is preprogrammed with a start time and a duration.
- where the receiver turns itself on at the preprogrammed start time and the point occupation begins.
- where the receiver stops point occupation and stores the point after the preprogrammed duration.

Up to twenty wake-up sessions can be configured which are totally independent of each other.



A CompactFlash card must be inserted when the receiver wakes up. If no CompactFlash card is fitted or it is damaged, not formatted or full then the session will not be executed.



The PIN code, if activated in **CONFIGURE Start Up & Power Down, PIN Code** page, is not checked if a wake-up session starts.

Access

Select **Main Menu: Programs...Wake-Up**.

OR

Press **PROG**. Highlight **Wake-Up**. **CONT (F1)**. Refer to "36.2 Accessing the Application Programs Menu" for information on the **PROG** key.

OR

Press a hot key configured to access the screen **WAKE-UP Wake-Up Sessions**. Refer to "6.1 Hot Keys" for information on hot keys.

OR

Press **USER**. Refer to "6.2 USER Key" for information on the **USER** key.

WAKE-UP Wake-Up Sessions

No.	Start Date	Start Time	Repeat
1	10.12.03	14:10:00	5
2 P	08.12.03	10:00:00	1

CONT NEW EDIT DEL Q1a ↑

CONT (F1)

To return to the screen from where this screen was accessed.

NEW (F2)

To create a new wake-up session. Refer to "49.2 Creating a New Wake-Up Session".

EDIT (F3)

To edit a wake-up session. Refer to "49.3 Editing a Wake-Up Session".

DEL (F4)

To delete a wake-up session.

SHIFT DEL-A (F4)

To delete all stored wake-up sessions.

Description of columns

Column	Description
No.	The wake-up session number, from 1 to 20.
P	Indicates which wake-up session is next to be activated.
Start Date	The local starting date of the wake-up session.
Start Time	The local starting time of the wake-up session.
Repeat	The number of times the wake-up session will be repeated.

Next step

IF	THEN
the wake-up sessions do not need to be changed	CONT (F1) closes the screen and returns to the screen from where WAKE-UP Wake-Up Sessions was accessed.
a wake-up session is to be created	NEW (F2) . Refer to "49.2 Creating a New Wake-Up Session".
a wake-up session is to be edited	highlight the wake-up session and EDIT (F3) . Refer to "49.3 Editing a Wake-Up Session".

49.2

Creating a New Wake-Up Session

Access step-by-step

Step	Description
1.	Refer to "49.1 Overview" to access WAKE-UP Wake-up Sessions .
2.	NEW (F2) to access WAKE-UP New Wake-Up Session .



A CompactFlash card must be fitted in the receiver for the wake-up session to take place. A new wake-up session can still be created when there is no CompactFlash card fitted, though there will be differences in the way the menu works:

- **<Job:>** is an output field.
- The options for **<Pt Input:>** are **Manual** and **Pt ID Template**.

WAKE-UP New Wake-Up Session, General page

14:10
WAKE-UP
New Wake-Up Session
General | Timing
Config Set : RT_Ref
Job : WGS84 Job
Pt Input : From Job
Point ID : 101
Antenna Ht : 1.3360 m
STORE PAGE

STORE (F1)

To store the changes and to return to the screen from where this screen was accessed.

TMPLT (F3)

Available for some options for **<Pt Input:>**. To configure ID templates. Refer to "19.1 ID Templates".

PAGE (F6)

To change to another page on this screen.

Description of fields

Field	Option	Description
<Config Set:>	Choicelist	The active configuration set for the wake-up session. All configuration sets from Main Menu: Manage...\Configurations Sets can be selected.
<Job:>	Choicelist	The active job for the wake-up session. All jobs from Main Menu: Manage...\Jobs can be selected.
<Pt Input:>	<p>From Job</p> <p>Manual</p> <p>Pt ID Template</p>	<p>Determines what options are available for <Point ID:>.</p> <p>Allows points from the job to be selected for <Point ID:>.</p> <p>Allows the point ID to be manually entered for <Point ID:>.</p> <p>Allows points from an point ID template to be entered for <Point ID:>. TMPLT (F3) is enabled so that the ID templates can be configured. Refer to "19.1 ID Templates".</p>
<Point ID:>	<p>Choicelist</p> <p>User input</p>	<p>The available options depend on the selection for <Pt Input:>.</p> <p>Available for <Pt Input: From Job>. A point ID can be selected from WAKE-UP Data: Job Name. Refer to "9 Manage...\Data".</p> <p>Available for <Pt Input: Manual>. Input a new point ID.</p>

Field	Option	Description
	Output	Available for <Pt Input: Pt ID Template>. A point ID can be selected from an ID template using TMPLT (F3) .
<Antenna Ht:>	User input	Height of the antenna to be used during the wake-up session. Changing the antenna height here does not update the default antenna height as defined in the active configuration set. The changed antenna height is used until the application program is exited.

Next step

PAGE (F6) changes to the **Timing** page. Refer to paragraph "WAKE-UP New Wake-Up Session, Timing page".

WAKE-UP New Wake-Up Session, Timing page

18:15
WAKE-UP
Edit Wake-Up Session
General | Timing
Start Date : 22.03.06
Start Time : 19:18:00
Start Occupat: 19:20:00
Duration : 00:03:00
End Time : 19:23:00
No. of Repeat: 5
Interval : 000-10-00
STORE PAGE

STORE (F1)

To store the changes and to return to the screen from where this screen was accessed.

PAGE (F6)

To change to another page on this screen.

Description of fields

Field	Option	Description
<Start Date:>	User input	Local date to start wake-up session. The earliest date that can be input is the current date.
<Start Time:>	User input	Local time to start wake-up session. There must be at least three minutes between consecutive wake-up sessions. No wake-up session can coincide with another session.
<Start Occupat:>	User input	Local time to start the point occupation (two minutes after <Start Time:>).
<Duration:>	User input	Length of time the wake-up session should last for. The minimum time a wake-up session can run for is three minutes and the maximum is forty-eight hours.
<End Time:>	Output	Time wake-up session will end calculated from the start time and duration.
<No. of Repeat:>	User input	Number of times the wake-up session should be repeated (max. 1000).
<Interval:>	User input Not Available	Time interval between repeated wake-up sessions. Unless <No. of Repeat: 1>. When <No. of Repeat: 1>.

Next step

STORE (F1) returns to **WAKE-UP Wake-Up Sessions**.

49.3

Editing a Wake-Up Session

Access step-by-step

Step	Description
1.	Refer to "49.1 Overview" to access WAKE-UP Wake-Up Sessions .
2.	EDIT (F3) to access WAKE-UP Edit Wake-Up Session .
3.	The editing of a wake-up session is identical to creating a new wake-up session. Refer to "49.2 Creating a New Wake-Up Session" for a description of the softkeys and fields.

Appendix A Menu Tree

Menu tree

MAIN MENU

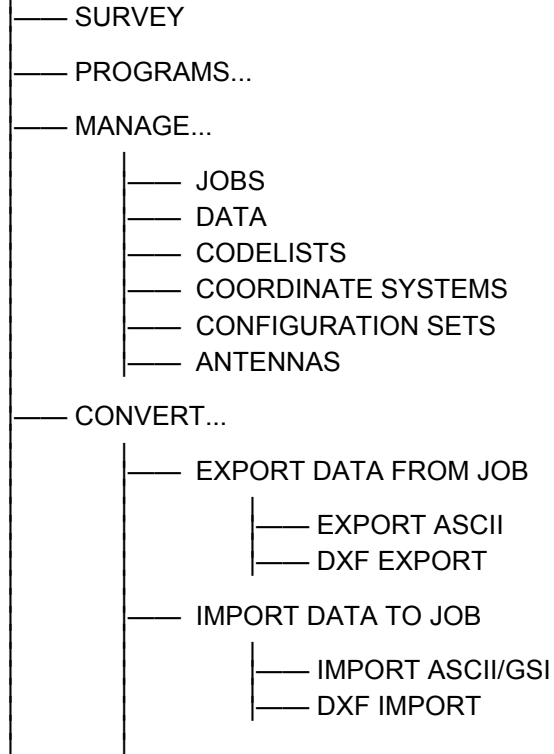

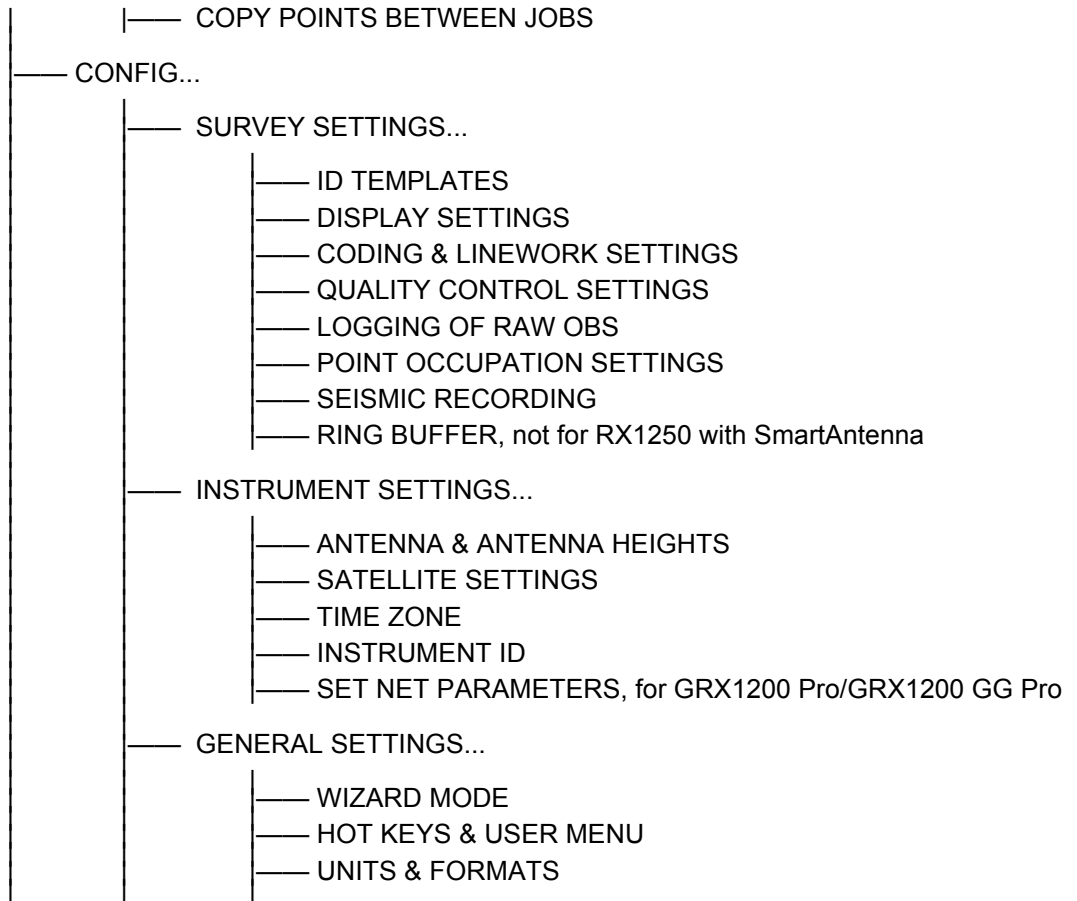

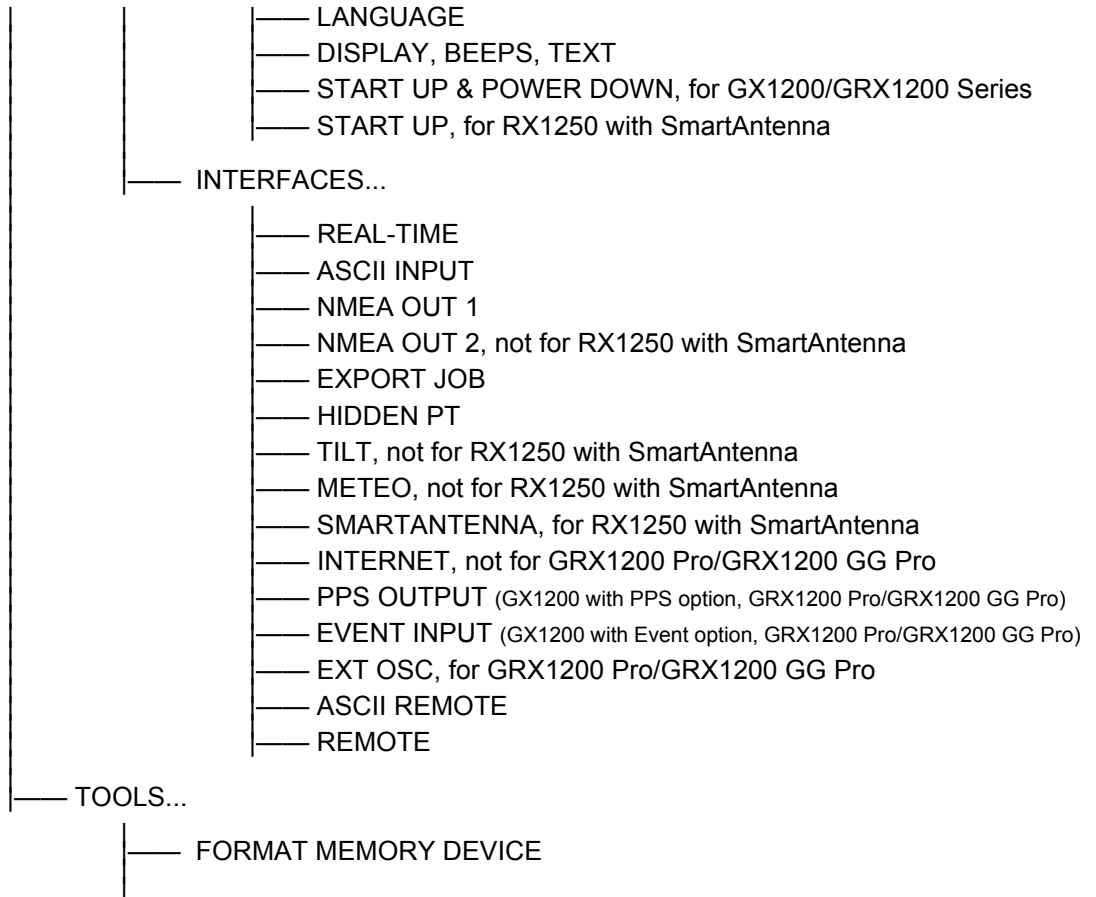

- TRANSFER OBJECTS...
 - CODELISTS
 - CONFIGURATION SETS
 - COORDINATE SYSTEMS
 - GEOID FIELD FILES
 - CSCS FIELD FILES
 - FORMAT FILES
 - JOBS, if internal memory is fitted
 - SYSTEM RAM CONTENTS
 - MODEM/GSM STATIONS
 - IP HOSTS
 - ANTENNA RECORDS
 - PZ-90-TRANSFORMATION
 - UPLOAD SYSTEM FILES...
 - APPLICATION PROGRAMS
 - SYSTEM LANGUAGES
 - INSTRUMENT FIRMWARE
 - CALCULATOR
 - FILE VIEWER
 - LICENCE KEYS
-

Appendix B Memory Types

Types of memory available

CompactFlash card/Internal memory

- Jobs
 - Points
 - Codes
- Coordinate systems
- Raw observations
- ASCII output files
- Logfiles
- ASCII files to be imported (CompactFlash card)
- Ring buffer files (CompactFlash card)
- CSCS field files (usually on System RAM, can also be used from CompactFlash card)
- Geoid field files (usually on System RAM, can also be used from CompactFlash card)

The information is managed in the job database DB-X and in the measurement database.

Application programs memory, 8 MB

- System language
- Font files
- Application programs

System RAM, 1 MB

- Codelists
- Coordinate systems
- Configuration sets

- Language files
- Font files

- Antenna files
- Format files
- CSCS models/CSCS field files
- Geoid models/Geoid field files
- Almanac
- ID templates

Appendix C Directory Structure of the Memory Device

Description

On the memory device, files are stored in certain directories. The following diagram of the directory structure refers to both CompactFlash card and internal memory if fitted. Backwards compatible with Leica GPS System 500 are geoid field files, CSCS field files and GSI files.

Directory structure

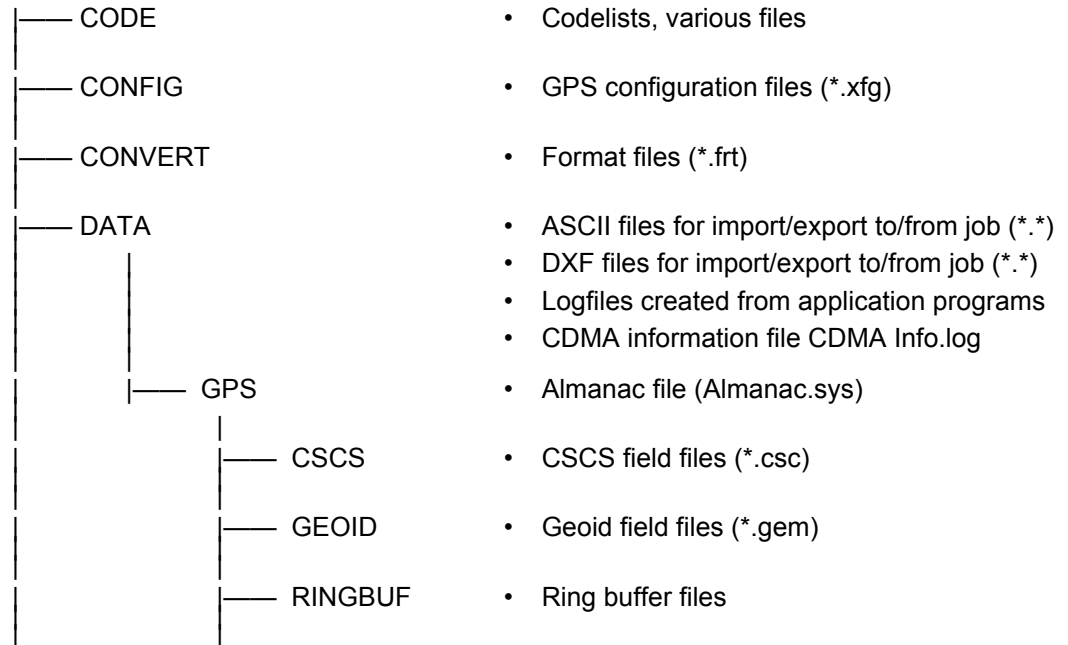

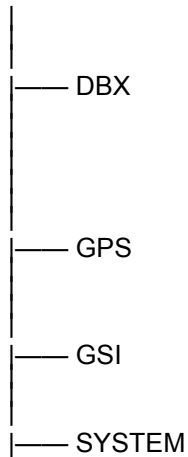

RINEX

- RINEX files
- Job files, various files
- DTM jobs, various files
- System 1200 coordinate system file (Trfset.dat)
- Antenna file (List.ant)
- GSM/Modem station list (Stations1200.fil)
- GSI files (*.gsi)
- ASCII files for export from job (*.*)
- Application program files (*.a*)
- Firmware files (*.fw)
- Language files (*.s*)
- Licence file (*.key)
- System files (System.ram)

Appendix D Pin Assignments and Sockets

D.1

Receiver

Description

Some applications require knowledge of the pin assignments for the receiver ports. In this chapter, the pin assignments and sockets for the ports of the receiver front panel are explained.

Ports at the receiver front panel

GX1210, GX1220, GX1220 GG, GX1230, GX1230 GG, GX1200 with PPS/Event option, GRX1200 Classic and GRX1200 Lite

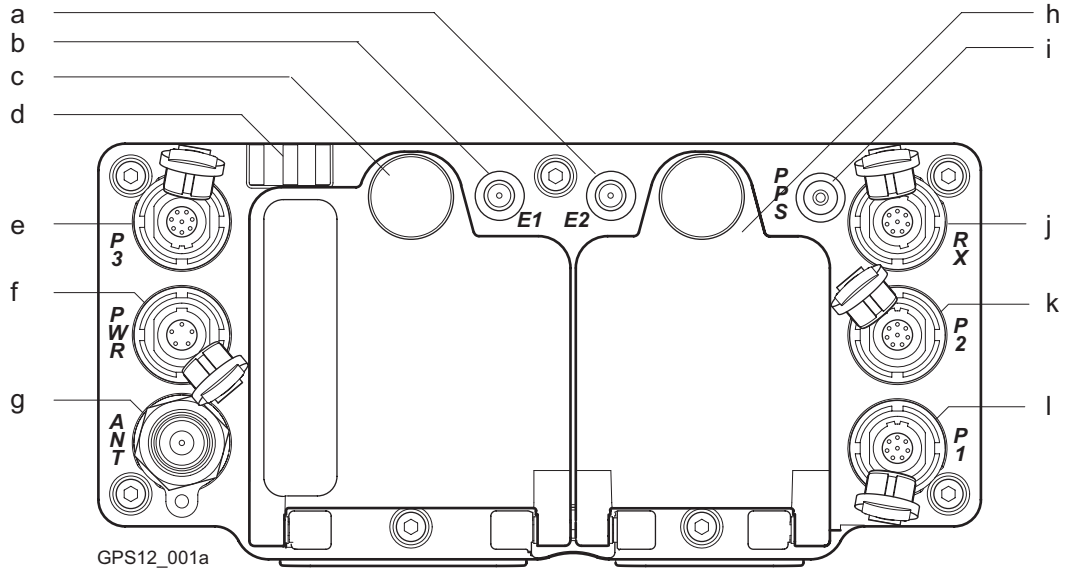

- a) Port E2: Event input 2, on GX1200 with PPS/Event option
- b) Port E1: Event input 1, on GX1200 with PPS/Event option
- c) Battery compartment A with CompactFlash card compartment
- g) Port ANT: GNSS antenna in.
- h) Battery compartment B, not for GRX1200 Pro/GRX1200 GG Pro
- i) Port PPS: PPS output, on GX1200 with PPS/Event option

- d) LED indicators
- e) Port P3: Power out, data in/out, or remote interface in/out. 8 pin LEMO
- f) Port PWR: Power in. 5 pin LEMO
- g) Port TX: TX1200 in/out or remote interface in/out. 8 pin LEMO
- h) Port P4: Power out, data in/out, or remote interface in/out. 8 pin LEMO
- i) Port P5: Power out, data in/out, or remote interface in/out. 8 pin LEMO
- j) Port RX: RX1200 in/out or remote interface in/out. 8 pin LEMO
- k) Port P2: Power out, data in/out, or remote interface in/out. 8 pin LEMO
- l) Port P1: Power out, data in/out, or remote interface in/out. 8 pin LEMO

GRX1200 Pro/GRX1200 GG Pro

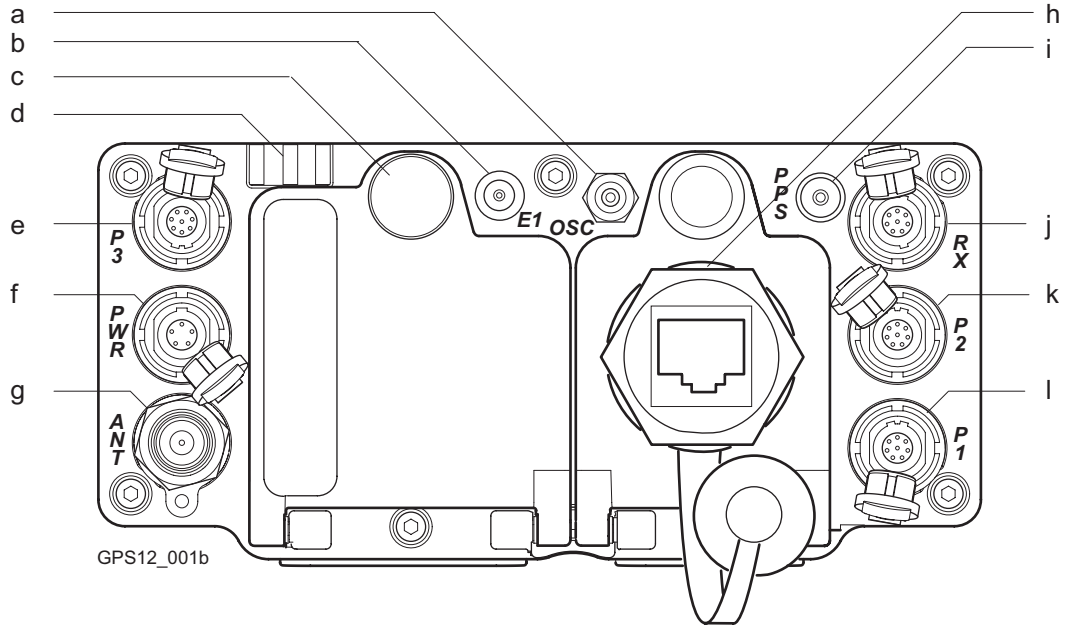

- a) Port OSC: External oscillator, in
- b) Port E1: Event input
- c) Battery compartment with CompactFlash card compartment
- g) Port ANT: GNSS antenna in
- h) Port NET: Ethernet/LAN data in/out, or remote interface.
- i) Port PPS: PPS out

- d) LED indicators
- e) Port P3: Power out, data in/out, or remote interface in/out. 8 pin LEMO
- f) Port PWR: Power in. 5 pin LEMO
- j) Port RX: RX1200 in/out or remote interface in/out. 8 pin LEMO
- k) Port P2: Power out, data in/out, or remote interface in/out. 8 pin LEMO
- l) Port P1: Power out, data in/out, or remote interface in/out. 8 pin LEMO

Pin assignments for port P1, port P2 and port P3

Pin	Name	Description	Direction
1	RTS	RS232, ready to send	Out
2	CTS	RS232, clear to send	In
3	GND	Signal ground	-
4	RxD	RS232, receive data	In
5	TxD	RS232, transmit data	Out
6	ID	Identification pin	In
7	GPIO	RS232, configurable function	In or out
8	+12 V	12 V power supply out	Out

Pin assignments for port RX

Pin	Name	Description	Direction
1	-	Do not use	-
2	-	Do not use	-
3	GND	Signal ground	-
4	RxD	RS232, receive data	In
5	TxD	RS232, transmit data	Out

Pin	Name	Description	Direction
6	ID	Identification pin	In
7	GPIO	RS232, configurable function	In or out
8	TRM_PWR	Power out, unregulated, 5 - 28 V	-

Pin assignments for port PWR

Pin	Name	Description	Direction
1	PWR1	Power input, 11 - 28 V	In
2	ID1	Identification pin	In
3	GND	Signal ground	-
4	PWR2	Power input, 11 - 28 V	In
5	ID2	Identification pin	In

Pin assignments for port NET

Pin	Name	Description	Direction
1	TX+	Transmit data +	Out
2	TX-	Transmit data -	Out
3	RX+	Receive data +	In
4	-	-	-
5	-	-	-
6	RX-	Receive data -	In
7	-	-	-
8	-	-	-

Sockets

Port P1, port P2 and port P3:	LEMO-1, 8 pin, LEMO HMA.1B.308.CLNP
Port RX:	LEMO-1, 8 pin, LEMO HM, Code New.1B.308.CLNP
Port PWR:	LEMO-1, 5 pin, LEMO HMG.1B.305.CLNP
Port E1 and port E2:	LEMO HGP.00.250.CTL
Port PPS:	LEMO ERN.0S.250.CTL
Port OSC:	24QMA-50-2-3/133
Port NET:	RJ-45

D.2

SmartAntenna

Description

Some applications require knowledge of the pin assignments for the SmartAntenna ports. In this chapter, the pin assignments and sockets for the ports of the SmartAntenna are explained.

Ports at the SmartAntenna

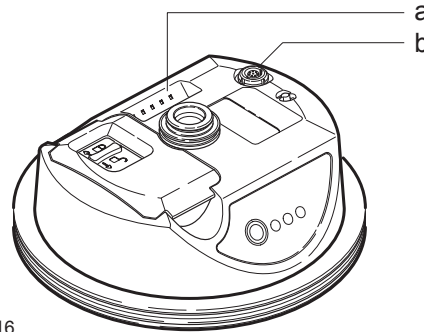

TPS12_216

- a) Clip-on-contacts for connecting SmartAntenna to SmartAntenna Adapter on TPS1200
- b) 8 pin LEMO-1 to connect antenna cable

**Pin assignments for
8 pin LEMO-1**

Pin	Name	Description	Direction
1	USB_D+	USB data line	In or out
2	USB_D-	USB data line	In or out
3	GND	Signal ground	-
4	RxD	RS232, receive data	In
5	TxD	RS232, transmit data	Out
6	ID	Identification pin	In or out
7	PWR	Power input, 5 -28 V	In
8	ATX_ON	ATX on control signal, RS232 levels	In

Sockets

8 pin LEMO-1: LEMO-1, 8 pin, LEMO HMI.1B.308.CLNP

D.3

RX1250

Description

Some applications require knowledge of the pin assignments for the RX1250 ports. In this chapter, the pin assignments and sockets for the ports of the RX1250 are explained.

Ports at the RX1250

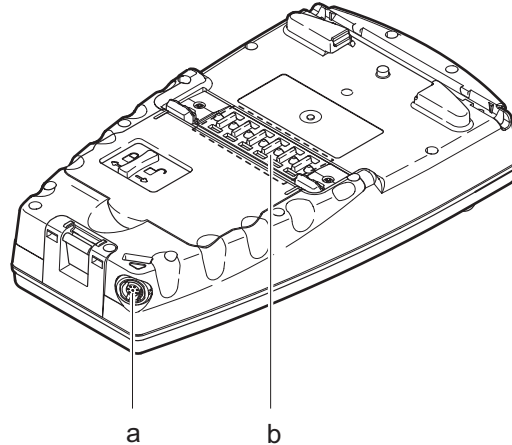

RX12_040

- a) 8 pin LEMO-1 to connect data cable
- b) Clip-on-contacts for connecting RX1250 to GHT56 holder

**Pin assignments for
8 pin LEMO-1**

Pin	Name	Description	Direction
1	USB_D+	USB data line	In or out
2	USB_D-	USB data line	In or out
3	GND	Signal ground	-
4	RxD	RS232, receive data	In
5	TxD	RS232, transmit data	Out
6	ID	Identification pin	In or out
7	PWR	Power input, 5 -28 V	In
8	TRM_ON/USB_ID	RS232, general purpose signal	In

Sockets

8 pin LEMO-1: LEMO-1, 8 pin, LEMO HMI.1B.308.CLNP

Appendix E Cables

Description

Some applications require the connection of instruments, devices or accessories to the GPS1200. In this chapter, the required cables and their use are listed.

Cables connecting instruments, devices or accessories

The table shows in alphabetical order which instruments, devices or accessories can be connected using cables. Refer to paragraph "Cables and product names" for a full description of these cables.

From	To	Cables
AX1200	GPS1200	<ul style="list-style-type: none"> • GEV108 • GEV119 • GEV120 • GEV134 • GEV141 • GEV142 • GEV194 • Cable 70 m, GNSS antenna
	GRX1200 Pro/ GRX1200 GG Pro	<ul style="list-style-type: none"> • GEV108 • GEV119 • GEV120 • GEV134

From	To	Cables
		<ul style="list-style-type: none"> • GEV141 • GEV142 • GEV194 • Cable 70 m, GNSS antenna
Car battery	GPS1200	<ul style="list-style-type: none"> • GEV97 + GEV71
	GRX1200 Pro/ GRX1200 GG Pro	<ul style="list-style-type: none"> • GEV97 + GEV71 • GEV172 + GEV71
	TPS1200	<ul style="list-style-type: none"> • GEV52 + GEV71
Device for Event Input	GPS1200	<ul style="list-style-type: none"> • GEV42
	GRX1200 Pro/ GRX1200 GG Pro	<ul style="list-style-type: none"> • GEV42
Device for PPS	GRX1200 Pro/ GRX1200 GG Pro	<ul style="list-style-type: none"> • GEV150
Ethernet communication device	GRX1200 Pro/ GRX1200 GG Pro	<ul style="list-style-type: none"> • GEV168
GEB171 or GEV208	GPS1200	<ul style="list-style-type: none"> • GEV97 • GEV97 + GEV172
	GRX1200 Pro/ GRX1200 GG Pro	<ul style="list-style-type: none"> • GEV97 • GEV97 + GEV172
	RX1250	<ul style="list-style-type: none"> • GEV215
	SmartAntenna	<ul style="list-style-type: none"> • GEV215

From	To	Cables
	TPS1200	• GEV52
Modem	GPS1200	• GEV113
	GRX1200 Pro/ GRX1200 GG Pro	• GEV113
Oscillator, external	GRX1200 Pro/ GRX1200 GG Pro	• GEV169
Power supply for GPS receiver, 12 V DC	GPS1200	• GEV172
	GRX1200 Pro/ GRX1200 GG Pro	• GEV172
Radio housing	Radio antenna on radio antenna arm	• GEV141
RS232 9 pin on PC	GFU14	• GEV171
	GPS1200	• GEV160 • GEV162
	GRX1200 Pro/ GRX1200 GG Pro	• GEV160 • GEV162
	RX1250	• GEV162
	SmartAntenna	• GEV162
	TPS1200	• GEV102 • GEV187

From	To	Cables
RX1210	GPS1200	<ul style="list-style-type: none"> • GEV163 • GEV164
	GRX1200 Pro/ GRX1200 GG Pro	<ul style="list-style-type: none"> • GEV163 • GEV164
RX1250	SmartAntenna	<ul style="list-style-type: none"> • GEV173 • GEV215
	TPS1200	<ul style="list-style-type: none"> • GEV217
Satellite radio	GPS1200	<ul style="list-style-type: none"> • GEV125
	GRX1200 Pro/ GRX1200 GG Pro	<ul style="list-style-type: none"> • GEV125
System 500 GFU	GPS1200	<ul style="list-style-type: none"> • GEV167
	GRX1200 Pro/ GRX1200 GG Pro	<ul style="list-style-type: none"> • GEV167
TCPS27	TPS1200	<ul style="list-style-type: none"> • GEV186
USB on PC	GPS1200	<ul style="list-style-type: none"> • GEV195
	GRX1200 Pro/ GRX1200 GG Pro	<ul style="list-style-type: none"> • GEV195
	RX1250	<ul style="list-style-type: none"> • GEV161
	TPS1200	<ul style="list-style-type: none"> • GEV189

Cables and product names

The product names of the cables in the above table are explained in detail below in ascending order.

Name	Description
-	Cable 70 m, GNSS antenna
GEV42	Cable, Event input for GPS
GEV52	Cable 1.8 m, TPS1200 to battery
GEV71	Cable 4.0 m, LEMO to 12 V DC power supply It allows a connection to a 12 V DC power supply for example a car battery. Cables used to connect to a GEB171 battery can be connected to adapter cable number 7.
GEV97	Cable 1.8 m, GX power cable
GEV102	Cable 2.0 m, TPS1200 to RS232
GEV108	Cable 30 m, GNSS antenna
GEV113	Cable, GX com to modem
GEV119	Cable 10 m, GNSS antenna
GEV120	Cable 2.8 m, GNSS antenna
GEV125	Cable, Satellite without housing to GX
GEV134	Cable 50 m, GNSS antenna
GEV141	Cable 1.2 m, GNSS antenna
GEV142	Cable 1.6 m, GNSS antenna, extension
GEV150	Cable, PPS output for GPS
GEV160	Cable 2.8 m, data transfer GX COM to RS232

Name	Description
GEV161	Cable 2.8 m, data transfer GX RX1250 to USB
GEV162	Cable 2.8 m, data transfer GX RX to RS232
GEV163	Cable 1.8 m, RX to GX
GEV164	Cable 1.0 m, RX to GX, all-on-pole setup
GEV167	Cable 0.5 m, GX to System 500 GFU housings
GEV168	Cable 5.0 m, GX to Ethernet communication device
GEV169	Cable 2.0 m, GX to external oscillator
GEV171	Y-cable 1.8 m, programming cable, GFU14 to RS232 with power
GEV172	Cable 2.8 m, dual external power input
GEV173	Cable 1.2 m, SmartAntenna to RX1250
GEV186	Y-cable 1.8 m, TCPS27 to TPS1200 with power
GEV187	Y-cable 2.0 m, TPS1200 to RS232 with power
GEV189	Cable 2.8 m, data transfer TPS to USB
GEV194	Cable 1.8 m, GNSS antenna, all-on-pole setup
GEV195	Cable 2.8 m, data transfer GX to USB
GEV208	Power supply unit, 12 V DC
GEV215	Y-cable, SmartAntenna and RX1250 to GEB171
GEV217	Cable 1.8 m, TPS1200 to RX1250

Appendix F NMEA Message Formats

F.1

Overview

Description

National **Marine Electronics Association** is a standard for interfacing marine electronic devices. This chapter describes all NMEA-0183 messages which can be output by the receiver.

Access

To set the output of NMEA messages on the receiver

Select **Main Menu: Config...\Interfaces...\NMEA Out.**

OR

Within the configuration set wizard. Refer to "14 Manage...\Configuration Sets".

Steer from a connected device

Use a query message. Refer to the interface control documents for GPS1200 for information on this query message. The firmware CD contains these documents in electronic format.



A Talker ID appears at the beginning of the header of each NMEA message. The Talker ID can be user defined or standard (based on the NMEA 3.0). This is normally GP for GPS but can be changed in **CONFIGURE NMEA Output 1** or **CONFIGURE NMEA Output 2**.



CONFIGURE NMEA Output 2 is not available for RX1250 with SmartAntenna.

F.2

Used symbols for describing the NMEA formats

Description

NMEA messages consist of various fields. The fields are:

- Header
- Special format fields
- Numeric value fields
- Information fields
- Null fields

Certain symbols are used as identifier for the field types. These symbols are described in this section.

Header

Symbol	Field	Description	Example
\$	-	Start of sentence	\$
--ccc	Address	<ul style="list-style-type: none">• -- = alphanumeric characters identifying the talker Options: GP = GPS only GL = GLONASS only GN = G lobal N avigation S atellite S ystem	GPGGA

Symbol	Field	Description	Example
		<ul style="list-style-type: none"> ccc = alphanumeric characters identifying the data type and string format of the successive fields. This is usually the name of the message. 	

Special format fields

Symbol	Field	Description	Example
A	Status	<ul style="list-style-type: none"> A = Yes, Data Valid, Warning Flag Clear V = No, Data Invalid, Warning Flag Set 	V
llll.ll	Latitude	<ul style="list-style-type: none"> Degreesminutes.decimal Two fixed digits of degrees, two fixed digits of minutes and a variable number of digits for decimal fraction of minutes. Leading zeros are always included for degrees and minutes to maintain fixed length. 	4724.538950
yyyyy.yy	Longitude	<ul style="list-style-type: none"> Degreesminutes.decimal Three fixed digits of degrees, two fixed digits of minutes and a variable number of digits for decimal fraction of minutes. Leading zeros are always included for degrees and minutes to maintain fixed length. 	00937.046785

Symbol	Field	Description	Example
eeeeee.eee	Grid Easting	At the most six fixed digits for metres and three fixed digits for decimal fractions of metres.	195233.507
nnnnnn.nnn	Grid Northing	At the most six fixed digits for metres and three fixed digits for decimal fractions of metres.	127223.793
hhmmss.ss	Time	<ul style="list-style-type: none"> hoursminutesseconds.decimal Two fixed digits of hours, two fixed digits of minutes, two fixed digits of seconds and a variable number of digits for decimal fraction of seconds. Leading zeros are always included for hours, minutes and seconds to maintain fixed length. 	115744.00
mmddy	Date	<ul style="list-style-type: none"> Monthdayyear - two fixed digits of month, two fixed digits of day, two fixed digits of year. Leading zeros always included for month, day and year to maintain fixed length. 	093003
No specific symbol	Defined field	<ul style="list-style-type: none"> Some fields are specified to contain predefined constants, most often alpha characters. 	M

Symbol	Field	Description	Example
		<ul style="list-style-type: none"> Such a field is indicated by the presence of one or more valid characters. Excluded from the list of valid characters are the following that are used to indicate other field types: A, a, c, x, hh, hhmmss.ss, llll.ll, yyyyy.yy. 	

Numeric value fields

Symbol	Field	Description	Example
x.x	Variable numbers	<ul style="list-style-type: none"> Integer or floating numeric field Optional leading and trailing zeros. Decimal point and associated decimal-fraction are optional if full resolution is not required. 	73.10 = 73.1 = 073.1 = 73
hh_	Fixed HEX field	Fixed length HEX numbers	3F

Information fields

Symbol	Field	Description	Example
c--c	Variable text	Variable length valid character field	A
aa_	Fixed alpha field	Fixed length field of upper case or lower case alpha characters	N
xx_	Fixed number field	Fixed length field of numeric characters	1

Null fields

Symbol	Field	Description	Example
No symbol	Information unavailable for output	Null fields do not contain any information at all.	,,



Fields are always separated by a comma. Before the Checksum field there is never a comma.



When information for a field is not available, the position in the data string is empty.

F.3**GGA - Global Positioning System Fix Data****Syntax**

```
$--GGA,hhmmss.ss,llll.ll,a,yyyy.yy,a,x,xx,x.x,x.x,M,x.x,M,x.x,xxxx*hh<CR><LF>
```

Description of fields

Field	Description
\$--GGA	Header including Talker ID
hhmmss.ss	UTC time of position
llll.ll	Latitude (WGS 1984)
a	Hemisphere, N orth or S outh
yyyy.yy	Longitude (WGS 1984)
a	E ast or W est
x	Position quality indicator 0 = Fix not available or invalid 1 = No real-time position, navigation fix 2 = Real-time position, ambiguities not fixed 3 = Valid fix for GNSS P recise P ositioning S ervice mode, for example WAAS 4 = Real-time position, ambiguities fixed
xx	Number of satellites in use, 00 to 26.
x.x	HDOP

Field	Description
x.x	Altitude of position marker above/below mean sea level in metres. If no orthometric height is available the local ellipsoidal height will be exported. If the local ellipsoidal height is not available either, the WGS 1984 ellipsoidal height will be exported.
M	Units of altitude as fixed text M
x.x	Geoidal separation in metres. This is the difference between the WGS 1984 earth ellipsoid surface and mean sea level.
M	Units of geoidal separation as fixed text M
x.x	Age of differential GNSS data, empty when DGPS not used
xxxx	Differential reference station ID, 0000 to 1023
*hh	Checksum
<CR>	Carriage Return
<LF>	Line Feed

Examples

User defined Talker ID = GN

```
$GNGGA,113805.50,4724.5248541,N,00937.1063044,E,4,13,0.7,1171.281,M,-703.398,M,0.26,0000*42
```

F.4

GGK - Real-Time Position with DOP

Syntax

```
$--GGK,hhmmss.ss,mmddy,lll.l, a,yyyy.yy,a,x,xx,x.x,EHTx.x,M*hh<CR><LF>
```

Description of fields

Field	Description
\$--GGK	Header including Talker ID
hhmmss.ss	UTC time of position
mmddy	UTC date
lll.l	Latitude (WGS 1984)
a	Hemisphere, N orth or S outh
yyyy.yy	Longitude (WGS 1984)
a	E ast or W est
x	Position quality indicator 0 = Fix not available or invalid 1 = No real-time position, navigation fix 2 = Real-time position, ambiguities not fixed 3 = Real-time position, ambiguities fixed
xx	Number of satellites in use, 00 to 26.
x.x	GDOP
EHT	Ellipsoidal height
x.x	Altitude of position marker as local ellipsoidal height. If the local ellipsoidal height is not available, the WGS 1984 ellipsoidal height will be exported.

Field	Description
M	Units of altitude as fixed text M
*hh	Checksum
<CR>	Carriage Return
<LF>	Line Feed

Examples

Standard Talker ID

\$GNGGK,113616.00,041006,4724.5248557,N,00937.1063064,E,3,12,1.7,EHT1171.742,M
*6D

User defined Talker ID = GN

\$GNGGK,113806.00,041006,4724.5248557,N,00937.1063064,E,3,13,1.4,EHT1171.746,M
*66

F.5 GGK(PT) - Real-Time Position with DOP, Trimble Proprietary

Syntax

```
$PTNL,GGK,hhmmss.ss,mmddy,IIII.II,a,yyyy.yy,a,x,xx,x.x,EHTx.x,M*hh<CR><LF>
```

Description of fields

Field	Description
\$PTNL	\$ = Start of sentence delimiter, talker ID fixed with PTNL
GGK	GGK sentence formatter
hhmmss.ss	UTC time of position
mmddy	UTC date
IIII.II	Latitude (WGS 1984)
a	Hemisphere, N orth or S outh
yyyy.yy	Longitude (WGS 1984)
a	E ast or W est
x	Position quality indicator 0 = Fix not available or invalid 1 = No real-time position, navigation fix 2 = Not existing 3 = Real-time position, ambiguities fixed 4 = Real-time position, ambiguities not fixed
xx	Number of satellites in use, 00 to 26.
x.x	PDOP
EHT	Ellipsoidal height

Field	Description
x.x	Altitude of position marker as local ellipsoidal height. If the local ellipsoidal height is not available, the WGS 1984 ellipsoidal height will be exported.
M	Units of altitude as fixed text M
*hh	Checksum
<CR>	Carriage Return
<LF>	Line Feed

Examples

Standard Talker ID

\$PTNL,GGK,113616.00,041006,4724.5248557,N,00937.1063064,E,3,12,1.5,EHT1171.74
2,M*4C

User defined Talker ID = GN

\$PTNL,GGK,113806.00,041006,4724.5248557,N,00937.1063064,E,3,13,1.2,EHT1171.74
6,M*43

F.6

GGQ - Real-Time Position with CQ

Syntax

```
$--GGQ,hhmmss.ss,mmddy,lll.ll,a,yyyy.yy,a,x,xx,x.x,x.x,M*hh<CR><LF>
```

Description of fields

Field	Description
\$--GGQ	Header including talker ID
hhmmss.ss	UTC time of position
mmddy	UTC date
lll.ll	Latitude (WGS 1984)
a	Hemisphere, N orth or S outh
yyyy.yy	Longitude (WGS 1984)
a	E ast or W est
x	Position quality indicator 0 = Fix not available or invalid 1 = No real-time position, navigation fix 2 = Real-time position, ambiguities not fixed 3 = Real-time position, ambiguities fixed
xx	Number of satellites in use, 00 to 26.
x.x	Coordinate quality in metres

Field	Description
x.x	Altitude of position marker above/below mean sea level in metres. If no orthometric height is available the local ellipsoidal height will be exported. If the local ellipsoidal height is not available either, the WGS 1984 ellipsoidal height will be exported.
M	Units of altitude as fixed text M
*hh	Checksum
<CR>	Carriage Return
<LF>	Line Feed

Examples

Standard Talker ID

```
$GNGGQ,113615.50,041006,4724.5248556,N,00937.1063059,E,3,12,0.009,1171.281,M*22
$GPGGQ,113615.50,041006,,,08,,*67
$GLGGQ,113615.50,041006,,,04,,*77
```

User defined Talker ID = GN

```
$GNGGQ,113805.50,041006,4724.5248541,N,00937.1063044,E,3,13,0.010,1171.281,M*2E
```

F.7**GLL - Geographic Position Latitude/Longitude****Syntax**

```
$--GLL,IIII.II,a,yyyyy.yy,a,hhmmss.ss,A,a*hh<CR><LF>
```

Description of fields

Field	Description
\$--GLL	Header including talker ID
IIII.II	Latitude (WGS 1984)
a	Hemisphere, N orth or S outh
yyyyy.yy	Longitude (WGS 1984)
a	E ast or W est
hhmmss.ss	UTC time of position
A	Status A = Data valid V = Data not valid
a	Mode indicator A = Autonomous mode D = Differential mode N = Data not valid
*hh	Checksum
<CR>	C arriage R eturn
<LF>	L ine F eed



The Mode indicator field supplements the Status field. The Status field is set to A for the Mode indicators A and D. The Status field is set to V for the Mode indicator N.

Examples

Standard Talker ID

```
$GNGLL,4724.5248556,N,00937.1063059,E,113615.50,A,D*7B
```

User defined Talker ID = GN

```
$GNGLL,4724.5248541,N,00937.1063044,E,113805.50,A,D*7E
```

F.8

GNS - GNSS Fix Data

Syntax

```
$--GNS,hhmmss.ss,llll.ll,a,yyyy.yy,a,c--c,xx,x.x,x.x,x.x,x.x,xxxx*hh<CR><LF>
```

Description of fields

Field	Description
\$--GNS	Header including talker ID
hhmmss.ss	UTC time of position
llll.ll	Latitude (WGS 1984)
a	Hemisphere, N orth or S outh
yyyy.yy	Longitude (WGS 1984)
a	E ast or W est
c--c	Mode indicator N = Satellite system not used in position fix or fix not valid A = Autonomous; navigation fix, no real-time fix D = Differential; real-time position, ambiguities not fixed R = Real-time kinematic; ambiguities fixed
xx	Number of satellites in use, 00 to 99
x.x	HDOP
x.x	Altitude of position marker above/below mean sea level in metres. If no orthometric height is available the local ellipsoidal height will be exported. If the local ellipsoidal height is not available either, the WGS 1984 ellipsoidal height will be exported.

Field	Description
x.x	Geoidal separation in metres
x.x	Age of differential data
xxxx	Differential reference station ID, 0000 to 1023
*hh	Checksum
<CR>	Carriage Return
<LF>	Line Feed

Examples

Standard Talker ID

\$GNGNS,113616.00,4724.5248557,N,00937.1063064,E,RR,12,0.9,1171.279,-
703.398,0.76,0000*6C

\$GPGNS,113616.00,,,,,08,,,,*69

\$GLGNS,113616.00,,,,,04,,,,*79

User defined Talker ID = GN

\$GNGNS,113806.00,4724.5248547,N,00937.1063032,E,R,13,0.7,1171.283,-
703.398,0.76,0000*39

F.9 GSA - GNSS DOP and Active Satellites

Syntax

```
$--GSA,a,x,xx,xx,xx,xx,xx,xx,xx,xx,xx,xx,xx,xx,x.x,x.x,x.x*x*hh<CR><LF>
```

Description of fields

Field	Description
\$--GSA	Header including talker ID
a	Mode M = Manual, forced to operate in 2D or 3D mode A = Automatic, allowed to automatically change between 2D and 3D
x	Mode 1 = Fix not available 2 = 2D 3 = 3D
xx	Numbers of the satellites used in the solution. This field is repeated 12 times. 1 to 32 = PRN numbers of GPS satellites 33 to 64 = Numbers of WAAS and WAAS like satellites 65 to 96 = Slot numbers of GLONASS satellites
x.x	PDOP
x.x	HDOP
x.x	VDOP
*hh	Checksum
<CR>	Carriage Return

Field	Description
<LF>	Line Feed

Examples

Standard Talker ID

\$GNGSA,A,3,01,11,14,17,19,20,24,28,,,,,1.5,0.9,1.2*26

\$GNGSA,A,3,65,66,67,81,,,,,,,,,1.5,0.9,1.2*29

User defined Talker ID = GN

\$GNGSA,A,3,01,11,14,17,19,20,23,24,28,,,65,66,67,81,,,,,,,,,1.2,0.7,1.0*27

F.10

GSV - GNSS Satellites in View

Syntax

```
$--GSV,x,x,xx,xx,xx,xxx,xx,.....*hh<CR><LF>
```

Description of fields

Field	Description
\$--GSV	Header including talker ID
x	Total number of messages, 1 to 4
x	Message number, 1 to 4
xx	Number of theoretically visible satellites according to the current almanac.
xx	PRN (GPS) / Slot (GLONASS) number of satellite
xx	Elevation in degrees, 90 maximum, empty when not tracking
xxx	Azimuth in degrees true North, 000 to 359, empty when not tracking
xx	Signal to Noise Ratio C/No in dB, 00 to 99 of L1 signal, null field when not tracking.
...	Repeat set PRN / Slot number, elevation, azimuth and SNR up to four times
*hh	Checksum
<CR>	Carriage Return
<LF>	Line Feed



Satellite information may require the transmission of multiple messages, specified by the total number of messages and the message number.



The fields for the PRN / Slot number, Elevation, Azimuth and SNR form one set. A variable number of these sets are allowed up to a maximum of four sets per message.

Examples

Standard Talker ID

\$GPGSV,3,1,11,01,55,102,51,11,85,270,50,14,31,049,47,17,21,316,46*7A

\$GPGSV,3,2,11,19,31,172,48,20,51,249,50,22,00,061,,23,11,190,42*7E

\$GPGSV,3,3,11,24,11,292,43,25,08,114,,28,14,275,44,,,,*45

\$GLGSV,2,1,06,65,16,055,42,66,64,025,48,67,46,262,42,68,01,245,*64

\$GLGSV,2,2,06,81,52,197,47,83,07,335,,,,,,,,*68

User defined Talker ID = GN

\$GNGSV,3,1,10,01,55,100,51,11,86,263,50,14,31,049,47,17,22,316,46*65

\$GNGSV,3,2,10,19,30,172,48,20,52,249,51,23,12,190,42,24,12,292,42*6C

\$GNGSV,3,3,10,25,09,114,,28,14,274,44,,,,,,,,*62

F.11**LLK - Leica Local Position and GDOP****Syntax**

```
$--LLK,hhmmss.ss,mmddyy,eeeeee.eee,M,nnnnnn.nnn,M,x,xx,x.x,x.x,M*hh<CR><LF>
```

Description of fields

Field	Description
\$--LLK	Header including talker ID
hhmmss.ss	UTC time of position
mmddyy	UTC date
eeeeee.eee	Grid Easting in metres
M	Units of grid Easting as fixed text M
nnnnnn.nnn	Grid Northing in metres
M	Units of grid Northing as fixed text M
x	Position quality 0 = Fix not available or invalid 1 = No real-time position, navigation fix 2 = Real-time position, ambiguities not fixed 3 = Real-time position, ambiguities fixed
xx	Number of satellites used in computation
x.x	GDOP
x.x	Altitude of position marker above/below mean sea level in metres. If no orthometric height is available the local ellipsoidal height will be exported.
M	Units of altitude as fixed text M

Field	Description
*hh	Checksum
<CR>	Carriage Return
<LF>	Line Feed

Examples

Standard Talker ID

\$GNLLK,113616.00,041006,764413.024,M,252946.774,M,3,12,1.7,1171.279,M*0F

\$GPLLK,113616.00,041006,,,,,08,,, *57

\$GLLLLK,113616.00,041006,,,,,04,,, *47

User defined Talker ID = GN

\$GNLLK,113806.00,041006,764413.021,M,252946.772,M,3,13,1.4,1171.283,M*04

F.12**LLQ - Leica Local Position and Quality****Syntax**

```
$--LLQ,hhmmss.ss,mmddy,eeeeee.eee,M,nnnnnn.nnn,M,x,xx,x.x,x.x,M*hh<CR><LF>
```

Description of fields

Field	Description
\$--LLQ	Header including talker ID
hhmmss.ss	UTC time of position
mmddy	UTC date
eeeeee.eee	Grid Easting in metres
M	Units of grid Easting as fixed text M
nnnnnn.nnn	Grid Northing in metres
M	Units of grid Northing as fixed text M
x	Position quality 0 = Fix not available or invalid 1 = No real-time position, navigation fix 2 = Real-time position, ambiguities not fixed 3 = Real-time position, ambiguities fixed
xx	Number of satellites used in computation
x.x	Coordinate quality in metres
x.x	Altitude of position marker above/below mean sea level in metres. If no orthometric height is available the local ellipsoidal height will be exported.
M	Units of altitude as fixed text M

Field	Description
*hh	Checksum
<CR>	Carriage Return
<LF>	Line Feed

Examples

Standard Talker ID

\$GNLLQ,113616.00,041006,764413.024,M,252946.774,M,3,12,0.010,1171.279,M*12

\$GPLLQ,113616.00,041006,,,,,08,,, *4D

\$GLLLQ,113616.00,041006,,,,,04,,, *5D

User defined Talker ID = GN

\$GNLLQ,113806.00,041006,764413.021,M,252946.772,M,3,13,0.010,1171.283,M*1A

F.13

RMC - Recommended Minimum Specific GNSS Data

Syntax

```
$--RMC,hhmmss.ss,A,llll.ll,a,yyyy.yy,a,x.x,x.x,xxxxxx,x.x,a*hh<CR><LF>
```

Description of fields

Field	Description
\$--RMC	Header including talker ID
hhmmss.ss	UTC time of position fix
A	Status A = Data valid V = Navigation receiver warning
llll.ll	Latitude (WGS 1984)
a	Hemisphere, N orth or S outh
yyyy.yy	Longitude (WGS 1984)
a	E ast or W est
x.x	Speed over ground in knots
x.x	Course over ground in degrees
xxxxxx	Date: ddmmyy
x.x	Magnetic variation in degrees
a	E ast or W est
a*hh	Mode Indicator A = Autonomous mode D = Differential mode

Field	Description
	N = Data not valid
<CR>	Carriage Return
<LF>	Line Feed

Examples

Standard Talker ID

\$GNRMC,113616.00,A,4724.5248557,N,00937.1063064,E,0.01,11.43,100406,11.43,E,D*1C

User defined Talker ID = GN

\$GNRMC,113806.00,A,4724.5248547,N,00937.1063032,E,0.00,287.73,100406,287.73,E,D*10

F.14**VTG - Course Over Ground and Ground Speed****Syntax**

```
$--VTG,x.x,T,x.x,M,x.x,N,x.x,K,a*hh<CR><LF>
```

Description of fields

Field	Description
\$--VTG	Header including talker ID
x.x	Course over ground in degrees true North, 0.0 to 359.9
T	Fixed text T for true North
x.x	Course over ground in degrees magnetic North, 0.0 to 359.9
M	Fixed text M for magnetic North
x.x	Speed over ground in knots
N	Fixed text N for knots
x.x	Speed over ground in km/h
K	Fixed text K for km/h
a	Mode Indicator A = Autonomous mode D = Differential mode N = Data not valid
*hh	Checksum
<CR>	Carriage Return
<LF>	Line Feed



The Magnetic declination is set in the receiver in **CONFIGURE\Units & Formats, Angle** page.

Examples

Standard Talker ID

```
$GNVTG,11.4285,T,11.4285,M,0.007,N,0.013,K,D*3D
```

User defined Talker ID = GN

```
$GNVTG,287.7273,T,287.7273,M,0.002,N,0.004,K,D*3E
```

F.15

ZDA - Time and Date

Syntax

```
$--ZDA,hhmmss.ss,xx,xx,xxxx,xx,xx*hh<CR><LF>
```

Description of fields

Field	Description
\$--ZDA	Header including talker ID
hhmmss.ss	UTC time
xx	UTC day, 01 to 31
xx	UTC month, 01 to 12
xxxx	UTC year
xx	Local zone description in hours, 00 to ±13
xx	Local zone description in minutes, 00 to +59
*hh	Checksum
<CR>	Carriage Return
<LF>	Line Feed



This message is given high priority and is output as soon as it is created. Latency is therefore reduced to a minimum.

Examples

Standard Talker ID

```
$GPZDA,091039.00,01,10,2003,-02,00*4B
```

User defined Talker ID = GN

```
$GNZDA,113806.00,10,04,2006,02,00*76
```

Appendix G Event Input Notify Message Format

Description

With GPS1200, a message can be created. This message provides information about

- the fact that an event was detected by the receiver
- the time when the event was detected.

The message can be in ASCII or in binary format. It is sent to a connected device, for example a PC.

Refer to "22.13 Event Input" for configuring the event input interface.

Access

Select **Main Menu: Config...\Interfaces...\Event Input** to activate the notify message.

Syntax in binary format

In binary, the notification message format is Leica Binary v2. Documentation for LB2 is available on request from the Leica Geosystems representative.

Syntax in ASCII

\$PLEIR,EIX,sssssssss,ttttttt,nnnn,cccc,dddd*hh<CR><LF>

Description of the fields

Field	Description
\$PLEIR	Header
EIX	Message identifier. X = 1 for port E1 X = 2 for port E2
sssssssss	GPS time of week of event in ms
ttttttt	GPS time of week of event in ns
nnnn	GPS week number

Field	Description
cccc	Event count
dddd	Event pulse count This is the count of all pulses including those violating the specified time guard boundary conditions set in CONFIGURE Event Input . This allows determination of missed events.
*hh	Checksum
<CR>	Carriage return
<LF>	Line feed

Example

\$PLEIR,EI2,292412000,28932,1203,203,1*70

Appendix H Seismic Record Format

Description

With GPS1200, seismic records may be generated. They are stored along with the point as an annotation. They can be exported directly from the receiver or imported into LGO. Refer to "22.4.3 Configuration of Annotations" for activating the recording of the seismic record format.

Access

Select **Main Menu: Config... \Survey \Seismic Recording** to activate the recording of seismic record formats.

Syntax

@GSEVMgg.gpp.phh.hvv.vaaa.aaasseeiiiRECRSN

Description of the fields

Field	Description
@	Record Flag, stored automatically
GSE	Record Type, GPS SE ismic
V	Version number of this record, one digit
M	Position type, one digit 0 = position not available 1 = navigated position 2 = differential code position 3 = differential phase, float solution 4 = differential phase, fixed solution
gg.g	GDOP, four digits including decimal point, 0.0 to 99.9
pp.p	PDOP, four digits including decimal point, 0.0 to 99.9

Field	Description
hh.h	HDOP, four digits including decimal point, 0.0 to 99.9
vv.v	VDOP, four digits including decimal point, 0.0 to 99.9
aaa.aaa	Antenna height as sum of instrument height and antenna offset, six digits including decimal point and minus, -99.99 to 999.99
ss	Number of satellites used for solution, two digits, 0 to 12
eee	Number of epochs spent on point, three digits, 0 to 999
ii	Length of interval between epochs in seconds, two digits, 0, 1, 2, 3, 4, 5, 6, 10, 12, 15, 30, 60
REC	Receiver type, six digits, SR299, SR399, SR299E, SR399E, SR9400, SR9500, SR510, SR520, SR530, GS50, GX1210, GX1220, GX1220 GG, GX1230, GX1230 GG
RSN	Receiver serial number, six digits, 0 - 999999

Example

@GSE14 2.4 2.0 1.1 1.7 2.000 8 7 1SR530 040000



When information for a value field of a seismic record is unavailable, the default value is written instead. This is 0.0 for the DOP values and the antenna height and 0 for all other fields.



All fields of a seismic record succeed without a separator. When the value for one field consists of less than the maximum number of digits, then blanks are written for the missing digits to keep the length of the field consistent.



Numbers are right aligned, text receiver type is left aligned.

Appendix I PPS Output Notify Message Format

Description

With GPS1200, a message can be created. This message informs about the output of a PPS pulse. The message can be in ASCII or in binary format. It is sent to a connected device, for example a PC.

The message is sent at least 0.5 s prior to the next pulse. For this reason, notify messages are sent when the PPS output rate is greater than 1 s.

Refer to "22.12 PPS Output" for configuring the PPS output interface.

Access

Select **Main Menu: Config...\Interfaces...\PPS Output** to activate the notify message.

Syntax in binary format

In binary, the notification message format is Leica Binary v2. Documentation for LB2 is available on request from the Leica Geosystems representative.

Syntax in ASCII

\$PLEIR,HPT,ssssssss,nnnn*hh<CR><LF>

Description of the fields

Field	Description
\$PLEIR	Header
HPT	Message identifier, H igh P riority T ime
ssssssss	GPS time of week of next PPS output in ms
nnnn	GPS week number
*hh	Checksum
<CR>	Carriage return
<LF>	Line feed

Example

\$PLEIR,HPT,134210000,1203*17

Appendix J AT Commands

AT commands

Hayes Microcomputer Products is a leading manufacturer of modems that has developed a language called the AT command set for controlling digital cellular phones and modems that has become the de facto standard.

List of selected AT commands

The characters in the table below are the most commonly used AT commands when configuring a digital cellular phone or modem. Refer to the manual of the used digital cellular phone or modem for information on which AT commands to use.

General commands

AT command	Description
^M	Inserts a carriage return and send command.
^#	Inserts the phone number as defined in digital cellular phone connection.
~	Inserts a delay of 1/4 second.
^^	Insert character ^.

GSM commands

AT command	Description
^C	Bearer Service: Connection Element.
^S	Bearer Service: Speed including Protocol and NetDataRate.

Index

Symbols

°DEC	658
°DMS	658

Numerics

1/X	659
10^X	659
3D transformation	933

A

ABS	183
Absolute coordinate difference	
Display	185
Limit exceeded	185
Absolute difference between two points	182
Access Point Name	586
ACCNT	682
Activate	
Code filter	212
Code group	211
Ring buffer	426
Adapter cable	1358
Adapter, screw-to-stub	98
ADD	885
Add point to line	194

ADD1	885
ADJ, class	162
ADJST	948
AirLink CDMA	579
Akasaka Tech	581
Almanac file, directory	1340
Almanac.sys	1340
Angle, display format	454
ANNOT	516
Annotations	
Add	1190
Configuration	518
Recall	1190
Antenna	430
Calibration	92
Create	343
Edit	345
Recall deleted default	342
Set default height	431
Antenna file, directory	1341
Antenna height	90
Determine	95
Antenna management, access	341
Antennas, default	340

APN	586	Application programs memory	1338
Application program		Formating	634
COGO	786	Arc Calculations,COGO calculation method	870
Customised	783	Arc, reference	1022
Delete	640	Area	
Description	782	Code	218
Determine coordinate system		Filter	211
General	932	Create	189
Normal	960	Delete	160
Loadable and non-loadable	782	Edit	193
Reference line	1022	Quick coding	255
Reference plane	1102	Area management	188
Stakeout	1124	Areas,sorting and filter	202
Survey		Arrow, orientate to	
Auto points	1204	Reference Line	1032
General	1162	Stakeout	1132
Hidden points	1232	ASCII	
Survey Cross Section	1274	Export format	346
Wake-up	1326	Import format	358
Application program file, directory	1341	ASCII file	
Application programs		Directory for import/export to/from job	1340
General information	782	ASCII input	
Maximum number open	785	Interface	515
Menu		Status	709
Access	134	ASCII Remote, interface	567
Description	784	ATCMD	591
Upload	640	AT-RXM500, Akasaka Tech	581

Attribute		Averaging mode	
Add for		Define	181
Free code	247	Description	181
Thematical code	240	AVGE	183
Description	218	AVGE, class	163
Type in new	231	AWAY	1262
Attribute mismatch	267	Azimuth, compute	
Attribute type	219	Determine coordinate system	1020
Attribute value region	220	Hidden point measurements	1261
Attribute value type	219	Azimuth/bearing fields	456
Auto points		AZMTH	1264
Averaging	1205	B	
Coding	1204	Backsight	756
Configure	1206	Backsight point, unknown	756
Properties	1205	Backward in Survey Cross Section	1281
Store	1209	Backwards Bearing & Distance	
Auxiliary points		Hidden point measurements	1259
Azimuth computation	1263	Backwards compatible with GPS System500	1340
Hidden point measurements	1234	Battery, status	702
Average	182	Bearing	456
Averaging	181	Bearing & Distance	
Auto points	1205	Hidden point measurements	1237
Configure	147	Bearing/azimuth fields	456
Cross section elements	1276	Beep	462
Hidden points	1234	Auto points	1210
Include/exclude coordinate triplet	184	Screen	463
Limit, exceeded	186	Bluetooth, identification number	598
Offset points	1219		
Staked points	1126		

C	
Cables	1354
Calculator	646
Operating mode	646
Calibration, antennas	92
Carrier	98
Cassini projection	310
CDMA	596
Connection, configure	601
CH-1	622
Chainage	
Format, Reference Line	1032
Reference Line	1025, 1032
Chainage & Offset	
Hidden point measurements	1253
Change	
Coordinate system	133
Radio channel, requirements	606
Channel changing, requirements	606
Circular level, adjust	86
Class	162
Classic 3D transformation	933
Results	981
Classification of points, hierarchy	162
Clear To Send	593
CLR X	657
CLRΣ	657
CMND	516, 600
CMR/CMR+, data format	482
Code	
Area	218
Create	230
Description	216
Edit	233
Free	217, 218
Line	218
Point	218
Quick	218
Thematical	217
Code filter for lines and areas	211
Code group	216
Activate/deactivate	211
Manage	234
Code mismatch	265
Code type	218, 230
Codelist	
Description	221
Elements	221
Job	222
System RAM	222
Codelist, directory	1340
Codelists	216

Codes	Inverse	791
Manage	Line Calculations	793
Job codes	Modify values	927
Point, line, area codes	Shift, Rotate & Scale (Manual)	795
Sort	Shift, Rotate & Scale (Match Pts)	796
Codelist management	Traverse	792
Data management	COGO points	
Coding	Coding	787
Auto points	Properties	787
COGO points	Combined Scale Factor	1007
Configure settings	Command, send to device	520
Cross section elements	Compatbile with Leica GPS System500	1340
Free	Computation, offset point	1219
Direct input	Config...	131
Using codelist	Configuration file, directory	1340
Hidden points	Configuration set	
Offset points	Default	320
Staked points	Description	320
Thematical	Recall deleted default	322
With codelist	Turn into user defined default	322
Without codelist	User defined	320
COGO	Wizard	320
Arc Calculations	Configure	
Area Division	Clip-on interface	119
Configure	SBAS	508
Distance input/output	SmartAntenna interface	117
End	Connect equipment and ports	29
Intersections		

Contrast, screen	463	Code	230
Control points	942	Codelist	226
Convert...	131	Coordinate system	293
Coordinate geometry calculations	786	CSCS models	319
Coordinate quality	169	Ellipsoid	305
Coordinate system	284	Geoid model	318
Active	286	Line	189
Change	133	Point	172
Create	293	Projection	312
Default	286	Reference arc	1038
Determine	932, 961	Reference line	1038
Edit		Reference plane	1115
Determine coordinate system	944	Transformation	300
Management	295	Criterion	585
Recall deleted default	291	Cross section element	
Turn into user defined default	291	Average	1276
Update	974	Coding	1276
Coordinate system file, directory	1341	Properties	1276
Coordinate system management, access	290	Cross Section Survey, configure	1280, 1310
Coordinate triplet	162	Cross Section Template, edit	1298
Coordinate types, display	176	csc file	319
Coordinates for real-time reference	1178	CSCS field file	319
Copy points between jobs	370	CSCS field file, directory	1340
Country Specific Coordinate System models	288	CSCS model	319
CQ	169	Create from CompactFlash card	319
Create		Description	288
Area	189	Types	288
		CSF	1007

Index	GPS1200	1406	
CSYS	133	Date, local	438
CTRL		DB-X	1338
CDMA	601	Deactivate	
Class	162	Code filter	212
Configure station to dial	624, 630	Code group	211
GSM	598	Ring buffer	426
Internet	615	Default, recall	
Modem	604	Antenna	342
NET port	618	Auto points, display mask settings	1211
Radio	607	Configuration set	322
RS232	609, 613	Coordinate system	291
SMARTgate	612	Devices	589
CTS	593	Display mask settings	388
CURNT	267	Ellipsoid	304
Current position, status	690	Instrument ID	440
Customised application program	783	Projection	308
Cut off angle	434	Transformation	298
D		DEL-A	1327
D -> R	658	Delete	
Data	156	Antenna	341
Data export	346	Application program	640
Data export, directory	349	Code	228
Data format, real-time	482	Code group	234
Data management	156	Codelist	224
Access	157	Configuration set	321
Database	1338	Coordinate system	291
		Coordinate triplet	185
		Cross section template	1290

Element in cross section template	1293	Transformation	298
Ellipsoid	303	DESCR	710
File	665	Determine coordinate system	
Format file		Access	944
COGO	802	Configure	947
Data export	350	Normal	947
Reference Line	1037	One point localisation	953
Reference Plane	1112, 1311	One point localisation	
Stakeout	1137	Classic 3D transformation	1016
From Data Log	200	Onestep transformation	986
Geoid model	317	Twostep transformation	998
ID template	382	DEVCE	588
Inverse COGO calculation	926	Device	574
Job	143	Configure	591
Language		Create	591
Configuration	460	Description	474
From System RAM	642	Edit	595
Line/area	160	Device height	
Logfile	802	Hidden point measurements	1269
Reference Line	1037	Devices	
Reference Plane	1112, 1311	Access CONFIGURE	588
Stakeout	1137	Configuration	574
Matched points	897, 966	Control	596
Observation files automatically	406	For Internet, configure	588
Point	158	Overview	574
Point from line	194	Recall deleted default	589
Projection	308	Difference limit exceeded in Stakeout	1158
Raw data of ring buffer	426		

Digital cellular phone		DTM job, directory	1341
Control	596	DTM layer, select	1129
User defined	577	DXF	359
Version	683	Data export	354
Digital cellular phones	575	Export format	347
Requirements for using	575	DXF Export	
Supported	576	Configuration	354
Dimensions, carrier and adapter	98	DXF file	
Directory structure of memory device	1340	Directory for import to job	1340
Display	462	E	
Coordinate types	176	e^X	660
Settings	386	EAO	
Display mask	386	Configure	542
Auto points	1211	Hidden point measurements	1239
Distance input/output in COGO	798	Edit	
Disto	585	Area	193
Distribution		Code	233
Residuals COGO Shift, Rotate & Scale	800	Codelist	226
Residuals throughout transformation area	949	Coordinate system	
DMASK		Determine coordinate system	944
Auto points	257, 1206	Management	295
General	387	Ellipsoid	306
Double Bearing		Job	149
Hidden point measurements	1242	Line	193
Double Distance		Measured coordinate triplet	184
Hidden point measurements	1247	Point	176
Double Stereographic projection	310	Projection	313

Transformation	302	Exceeded limit	
EGNOS	509	Absolute coordinate difference	185
Real-time data format	495	Auto points	1210
Electronic serial number	602	Average	186
Elevation mask	434	Coordinate quality	399
Ellipsoid		Difference in Stakeout	1158
Create	305	DOP	399
Delete	303	Height	
Edit	306	Reference Line	1034
Recall deleted default	304	Stakeout	1134
Ellipsoid distance in COGO	798	Position	
Ellipsoid management, access	303	Reference Line	1033
Ellipsoidal height	287	Stakeout	1134
Ellipsoids	303	Exclude coordinate triplet from averaging	184
End date, line/area	194	Expiry date, software maintenance	706
End time, line/area	194	Export format	346
Equipment setup	26	Export Job, interface	535
ESN number	602	Exporting cross section elements	1276
EST, class	164	EXPRT	150, 263
Ethernet, control	617	External oscillator, interface	564
European Geostationary Navigation		F	
Overlay Service	495	FACE	750, 1118
Overlay System	509	Field file	
Event input		CSCS	319
Interface	561	Geoid	314
Notification message format	1392	Field record sheet	111
Status	716	File, delete	665

FILT		Format file, export ASCII	346
Areas	160	Format files, directory	1340
Export	351	Formats	452
Height smoothing	494	Forward in Survey Cross Section	1281
Lines	160	Free code	217, 218
Management	158	Delete	200
Filter		Free coding	237
Activate/deactivate for codes	212	Frequency, change for radio	606
Point, line and area codes	211	Front panel	26
Points, lines and areas	202	Functions, main menu	130
Filter setting, define	158	G	
Filter symbol	202	Gateway	444
Firmware file, directory	1341	gem file	314
Firmware, version	706	General settings	446
FIX	948	GeoC++	783
FKP		Geoid field file	314
Flächenkorrekturparameter	501	Directory	1340
Flashing LED on receiver	110	Geoid model	314
Format		Create from	
Event input notify message	1392	CompactFlash card / internal memory	318
Export	346	Delete	317
Import	358	Description	287
Memory device	634	Management, access	316
Method	635	View	317
NMEA message	1360	Geoid separation	287
PPS output notify message	1396	Geoid, height above	287
Seismic record	1394		

GGA	511, 1366	GSM	597
GGA, key	511	GSM connection, configure	598
GGK	1368	GSV	1380
GGK(PT)	1370	H	
GGQ	1372	H PNT	1235
GLL	1374	Heating, screen	463
GNS	1376	Height	
GPRS	586	Ellipsoidal	287
GPRS device		Geoid	287
Requirements for using	586	Levelled	287
Supported	587	Mean sea level	287
User defined	587	Orthometric	287
Graph, showing satellites	676	Pole	104
Graphical display		Height filter	494
Elements in Stakeout application program	1138	Height mode	301
Grid distance in COGO	798	Height offset, stakeout	1135
Ground distance in COGO	798	Height smoothing	504
GROUP		Height type	
Codes	228	Current position	1125
Coding		Point to be staked	1125
Free	247	Heights, hidden point measurement	1269
Thematical	240	HEALTH	433
Job codes	153	Hidden point measurement devices	584
GSA	1378	Supported	585
GSI file, directory	1341	Hidden point measurement, heights	1269
GSI16	359	Hidden point, interface	538
GSI8	359		

Hidden points	1232	Illumination	
Averaging	1234	Keyboard	463
Coding	1234	Screen	463
Measure	1237	Import, format	358
Properties	1234	IMPRT	150
Hot keys		Include coordinate triplet in averaging	184
Configure	448	Increase point ID	376
Description	126	Increasing NE, SE, SW, NW	456
HTS	365	Incrementation	377
I		Point ID's	376
ID	156	Indicators, LED	109
ID templates	372	INDIV	1173
Identification number	440	Initialisation	1195
Bluetooth	598	Access	1197
IFACE		Methods	1195
Data export	352	Moving	1199
Export ASCII	535	On known point	1202
Status		Static	1200
ASCII input	709	Instrument firmware, upload	644
Event input	716	Instrument ID	440
Internet	715	Recall default	440
Meteo	713	Instrument settings	430
Real-time input	708	Instrument source	169
Remote	718	Interface	
SmartAntenna	714	Configure	475
Tilt	711	Description	474
		Remote port	28

Interfaces...	474
Status	708
Interference	606
Internet	
Control	617
Interface	554
Status	715
Internet device	
Requirements for using	586
Supported	587
User defined	587
Internet protocol	443
Intersections, COGO calculation method	834
Intuicom 1200 Data Link	580
INV	828
Inverse, COGO calculation method	803
J	
Job	
Active	142
Create	145
Default	142
Edit	149
Management	142
Job codelist	222
Job file, directory	1341

K

Keyboard, illumination	463
Keys	
Configure	126
Known point	
Initialisation method	1196

L

Lambert 1 Parallel projection	309
Lambert 2 Parallel projection	309
Language	
Delete	
Configuration	460
From System RAM	642
Select	460
Language file, directory	1341
Laser	
Ace 300	585
Locator	585
Last point, orientate to	
Reference Line	1031
Stakeout	1131
LASTX	660
Layer, DTM, select	1129
LED	109
Description	110

Leica		Upload	
Data format	482	Codelist to receiver	223
Disto	585	Coordinate systems	284
Laser Locator	585	Jobs	142
Vector	585	Licence file, directory	1341
Leica SmartWorx software on RX1250		Licence key	668, 782
Activate	113	Light Emitting Diode	109
Exit	114	Limit, exceeded	
Minimise	114	Absolute coordinate difference	185
Leica software on RX1250		Average	186
Access	113	Line	
Exit	130	Create	189
Minimise	130	Delete	160
Length	193	Edit	193
Levelled height	287	Orientate to	
LGO		Reference line	1031
Creation		Stakeout	1132
Antenna records	92	Quick coding	255
Attributes	219	Reference	1022
Codes	218	Line calculations, COGO calculation method	857
CSCS field files	319	Line code	218
DTM jobs	1154	Filter	211
Geoid field files	314	Line management	188
Quick codes	238	Line style	
Download		Coding	231
Coordinate systems	284	For line/area code	155
Jobs	142	New line	190

Lines, sorting and filter	202	Area	188
Linework	230, 270	Codelists	216
LIST	446	Configuration sets	320
List reference stations	621	Coordinate systems	284
LLK	1382	Data	156
LLQ	1384	Jobs	142
LN	659	Line	188
Loadable application program	782	Points	162
Local		Reference plane	1113
Date	439	MapView	722
Time	439	Access	724
LOG	199, 659	Configure	727
Log of messages	570	Example of results in plot mode	746
Log raw observations	401	Mode	
Logfile, create name		Description	722
COGO	802	Map	738
Reference Line	1037	Plot	744
Reference Plane	1112, 1311	Survey	749
Stakeout	1137	North arrow	734
Logfile, directory	1340	Overview	722
Logging status	694	Point symbols	737
M		Point with focus, symbol	735
Main menu	130	Scale bar	734
Manage...	131	Screen area	734
Management		Select Lines and Areas	754
Antennas	340	Select Points, Lines and Areas	740
		Softkeys	732
		Symbol rover	735

Toolbar		
Description	736	
Symbol	735	
Master-Auxiliary Correction	501	
MATCH	897, 966	
Match		
Point parameters	949	
Points	897, 966	
Matching points		
Choose	975	
Edit	977	
MAX	501	
Maximum number of open application programs	785	
Mean page	181	
Access	183	
Mean sea level, height	287	
MEAS, class	163	
Measure antenna height	90	
Measure to		
Arc	1040	
Line	1040	
Measured point	1024	
Measured points, properties		
Reference line	1023	
Reference plane	1102	
Mechanical Reference Plane	93	
Memory		
Device to be formatted	634	
Status	702	
Memory device, directory structure	1340	
Memory LED	109	
Memory types	1338	
Menu tree	1334	
Menu, application programs		
Access	134	
Description	784	
Mercator projection	309	
MESGS	528	
Message log	570	
Meteo		
Interface	550	
Status	713	
Minimise Leica software on RX1250	130	
Minipack	83	
Mismatch		
Attribute	267	
Code	265	
Mode, Calculator	646	
Modem	578	
Configure connection	604	
Control	604	
Requirements for using	578	
Supported	579	

User defined	579	Nokia 6230(i)	576
MODIF	832	Nokia 6310(i)	576
Modify values in COGO	927	Nokia 6630	576
Molodensky-Badekas	301	Nokia 6822a	576
Motorola E1000	576	Nokia N80	576
Motorola RAZR v3	576	NONE, class	164
MountPoint	773	None, coordinate system	286
Moving initialisation method	1195	Non-loadable application program	782
MRP	93	North, orientate to	
MSAS	509	Reference Line	1031
MSAS, real-time data format	495	Stakeout	1131
MTSAT		NPORT	
Satellite-based Augmentation System	495, 509	PPS output	559
MultiTech MTMMC-C (CAN)	576	Tilt	547
MultiTech MTMMC-C (US)	576	NTRIP	762
N		Number of satellites, used in solution	680
National Marine Electronics Association	1360	O	
NAV, class	163	Σ^-	657
Negative offset, COGO	825	Σ^+	657
New version, upload	640	Object	
Next available point ID		Delete	200
Real-time rover operations	1189	Description	156
Static operations	1173, 1315	Oblique Mercator projection	309
NMEA	1360	Occupation information, status	699
NMEA out, interface	527	Occupy staked point	1148
Nokia 6021	576	OFF button	108

Offset	Orthometric height	287
Antenna	Overwrite	
Input	Code for auto points	1204
Vertical	Point during import	360
External angle	OWI commands, status	706
Hidden point measurements		
Devices	P	
Reference line	Pacific Crest	
Reference plane	PDL GFU	580
Stakeout, height	RFM96W	581
Type in	PARA	494
COGO intersection	Parameters, set for transformation	950
COGO traverse	Personal Identification Number	
Offset point	GSM	600
Computation	Receiver	120, 466
Configure	Personal Unblocking code, GSM	600
Description	Personal Unblocking code, receiver	467
ID	Phase center variations, vertical	92
Examples	PI	658
ON button	Pillar setup	95
Onestep transformation	PIN	600
Results	GSM	600
Orientate	Receiver	466
Reference Line	Pin assignment	1342
Stakeout	PLAN	750, 1118
Origin, reference plane	PLANE	1122
ORIGN		
Orthogonal mode, stakeout		

Point		Points	
Add to line	194	Copy between jobs	370
Auto	1204	Quick coding	253
Auxiliary	1234	Points, sorting and filter	202
Azimuth computation	1263	Polar mode, stakeout	1150
COGO	787	Polar Stereographic projection	310
Create	172	Pole	
Delete	158	Height	104
Delete from line	194	Setup	103
Edit	176	Ports	
Hidden	1232	Connect equipment	29
Measured		Description	474
Reference line	1023	On receiver front panel	26
Reference plane	1102	POS?	1255
Occupation settings	407	Positive offset, COGO	825
Orientate to, Reference Line	1031	Post-processed kinematic	1167
Orientate to, Stakeout	1131	Power down	466
Staked, Stakeout	1126	Power LED	109
Point code	218	ppm, transformation results	979
Filter	211	PPS output	1396
Point ID		Interface	558
Incrementation	376	Prediction	
Next available		Advantages	504
Real-time rover operations	1189	Description	504
Static operations	1173, 1315	Recommended settings	504
Point management	162	PREV	774
Point symbols, MapView	737	PRN	676

PROG	784	Reference plane	1102
Programs... ..	131	Offset points	1219
PROGS	634	Staked points	1126
Projection		Protection by PIN/PUK	120, 466
Cassini	310	Pseudorandom Noise	676
Create	312	PUK	600
Delete	308	GSM	600
Double Stereographic	310	Receiver	467
Edit	313	Q	
Lambert 1 Parallel	309	Quadrant	456
Lambert 2 Parallel	309	Quick access to screens, configure	448
Mercator	309	Quick code	218
Oblique Mercator	309	Quick coding	237
Polar Stereographic	310	Line/area	255
Recall deleted default	308	Points	253
RSO	310	R	
Transverse Mercator	309	R -> D	658
UTM	309	Radio	580
Projection management, access	307	Change channels	606
Projections	307	Interference	606
Properties		Supported	580
Auto points	1205	User defined	581
COGO points	787	Version	684
Cross section element	1276	Radio down, log raw observations	403
Hidden points	1234	Radio Link Protocol	599
Manually occupied point	1182	RANGE	886
Measured points			
Reference line	1023		

Raw observations, log	401	Rectified Skewed Orthomorphic projection	310
RCL	660	REF, class	163
Ready To Send	593	Reference arc	
Real-time	478	Define	1039
Reference	1167	Define offsets	1052
Rover	1167	Delete	1047
Status	679	Enter manually	1039
Recall		Manage	1038
Annotations	1190	Measure to	1059
ASCII import settings	365	Select from job	1045
Default		Stake to	1073
Attribute values	174	Reference line	
Auto points, display mask settings	1211	Configure	1030
Display mask settings	388	Define	1039
Instrument ID	440	Define offsets	1052
Deleted default		Delete	1047
Antenna	342	Enter manually	1039
Configuration set	322	Manage	1038
Coordinate system	291	Measure to	1059
Devices	589	Select from job	1045
Ellipsoid	304	Stake to	1073
Projection	308	Reference plane	
Transformation	298	Application program	1102
Last used attribute values	174	Management	1113
Previous result, COGO	828	Tilted	1104
Receive data from third party device	515	Reference point	1023
Receiver status	109	Reference stations, list	621
RECT	659	REM A	886

Remote interface		RSLT1	843
Configure	570	RSLT2	843
Port	28	RSO projection	310
Residual		RT-1	491
Distribution COGO Shift, Rotate & Scale	800	RT-2	482
Distribution throughout transformation area	949	RTCM	
Results, hidden point measurements		Data format	483
Bearing and distance	1239	V3	483
Chainage and offset	1256	RTS	593
Double bearing	1244	RUN	1173
Double distance	1249	RX1200	
Resurvey staked point	1158	Control key beep	464
RINEX file, directory	1341	Exchange	462
Ring buffer	424	Use GPS1200 without RX1200	108
Activate	426	With/without touch screen	3
Configure	426	RX1200 firmware, upload	644
Deactivate	426	RX1250	
Use	426	Minimise Leica software	130
Ring buffer file, directory	1340	Put into sleep mode	130
RLP	599	Turn off	130
RMS	170	S	
Root Mean Square	170	S/N	676
Rotate, MapView	730	Same Direction, Survey Cross Section	1275
Rotations, set for transformation	951	SAPOS	583
RPN mode	646	Satellite	
RS232	582	2ASx	581
RS232, standard	582		

3AS	580	Ellipsoid	304
Satellite Positioning Service	583	Projection	308
Satellite status	674	Transformation	298
Satellites		Setup	26, 756
Health	434	Post-processed	
Number used in solution	680	Reference on pillar	30
Settings	433	Static, reference on tripod	34
SBAS		Post-processed kinematic	
Description	508	All-on-pole	
Key	508	Option 1	44
Scale		Option 2	48
Set for transformation	951	Pole and minipack	38
Transformation results	979	Real-time reference	
Scale factor, combined	1007	Single tripod	51
SCAN	621	SmartAntenna + RX1250	59
Screen		Two tripods	55
Contrast	463	Real-time rover	
Heating	463	All-on-pole	
Illumination	463	Option 1	77
SDEV	657	Option 2	80
Seismic record	1394	Pole and minipack	71
Seismic recording	421	SmartRover, external radio	63, 67
Select DTM layer	1129	Shift, Rotate & Scale	
Serial number	706	COGO, manual	882
SET-D		COGO, match points	896
Configuration set	322	Shifts, set for transformation	951
Coordinate system	291	Sideshot, Traverse COGO calculation	832

Siemens		
M20	576	
MC75	576, 587	
S25/S35i	576	
TC35	576	
Siemens M75	577	
Siemens S55	576	
Siemens S65	576	
Siemens S65v	576	
Signal to noise ratio	676	
Single Point Position	737	
Skip point in Stakeout	1158	
Skyplot	676	
Sleep mode on RX1250	130	
Slope		
Antenna height, measure	105	
Distance		
Hidden point measurements	1266	
SmartAntenna firmware, upload	644	
SmartAntenna, interface	551	
SmartCodes	256	
Assigning codes	262	
Code Block	261	
Configuration	257	
Copying Code Block	262	
Creating Code Block	261	
Measuring points	264	
SMARTgate	583	
Smartgate, control	611	
Smoothing heights	494	
Socket	1342	
Software upload	640	
Soldner Cassini projection	310	
SonyEricsson K700i	576	
SonyEricsson K750i	576	
SonyEricsson K800i	576	
SonyEricsson P900	576	
SonyEricsson S700i	576	
SonyEricssonT610	577	
Sort		
Codes		
Codelist management	228	
Data management	212	
Points, lines and areas	202	
Sort settings, define	158	
Source	165	
Space-Based Augmentation System	508	
SPP	737	
SRCE	502	
SSHOT	832	
Stake		
Arc, grid	1041	
Line, grid	1041	

Stake to	OWI commands	706
Arc	Receiver	109
Line	STO	660
Staked points	STORD	267
Average	Store, auto points	1209
Coding	Sub class	164
Properties, Stakeout	SUN	1262
Stakeout	Sun	
Configure	Azimuth computation	1261
Difference limit exceeded	Orientate to	
DTM	Reference Line	1031
Elements of graphical display	Stakeout	1131
Orthogonal mode	Survey	131
Polar mode	Access	1162
Standard deviation	Auto points	1204
Standard mode	Hidden points	1232
Start date	Points	1170
Start time	Post-processed kinematic operations	1170
Start up	Real-time	
STAT	Reference operations	1175
Static	Rover operations	1185
Initialisation method	Static operations	1170
Station to dial	Survey Cross Section	
Configure	Direction	1281
Create	Methods	1275
Edit	Survey Settings...	372
Status	Survey..., status	674

Surveying techniques	1166	Status	711
SV health	434	Time slicing	488
Switching, Leica SmartWorx software and Windows CE	113	Time stamp	237
Symbols, for points in MapView	737	Time zone	438
System file, directory	1341	Time, local	438
System information, status	706	Timed occupation	1192
System language		TMPLT	1329
Select	460	Tools...	131
Upload	642	Touch screen on, off	462
System languages, upload	642	TOWRD	1262
System RAM	1338	Tracking LED	109
System RAM codelist	222	Transfer objects	636
System500, backwards compatible	1340	Transformation	
SYSTM	634	Create	300
T		Delete	298
Talker ID	1360	Description	932
Target height, hidden point measurements	1269	Edit	302
Target point	1024	Recall deleted default	298
Template	1289	Requirements	932, 941
Template, Survey Cross Section	1274	Set parameters	950
Text	462	Transformation management, access	297
Thematical code	217	Transformation model	301
Thematical coding	236	Transformation parameters	933
Tilt	546	Transformations	297
Interface	546	Transverse Mercator projection	309
		Traverse, COGO calculation method	824
		Tribrach, adjust circular level	86

Triplet	162	View	
Tripod setup	100	File	664
Turn RX1250 off	130	Geoid model	317
Two real-time devices	577	Points, lines, areas, free code stored in job	158
Twostep transformation	939	Virtual Reference Station	501
Results	979	Volume Calculations	
Type in new attribute	231	End	1309
U		VRS	501
U.S. Robotics 56K	579	VTG	1388
Units	452	W	
Universal Transverse Mercator projection	309	WAAS	509
Unknown backsight point	756	WAAS, real-time data format	495
Update coordinate system	945	Wake-up session	1326
Upload		Create	1329
Application programs	640	Delete	1327
Firmware	644	Edit	1333
System files	640	Overview	1326
System language	642	Wavecom M1200 Series	576
User menu, configuration	448	WGS 1984	286
UTM projection	309	Wide Area Augmentation System	495, 509
V		Wildcard	205
Vector	585	Windows CE desktop, access	114
VERS	682	Windows CE, activate	113
Versions of system firmware	706	Windows key symbol	113, 114
Vertical offset, antenna	90, 101	Wizard	446

X

X²659

XY660

Y

Y^X659

Z

ZDA1390

ZigZag, Survey Cross Section1275

Zoom732

 Softkey732

 Window736

Total Quality Management: Our commitment to total customer satisfaction.



Leica Geosystems AG, Heerbrugg, Switzerland, has been certified as being equipped with a quality system which meets the International Standards of Quality Management and Quality Systems (ISO standard 9001) and Environmental Management Systems (ISO standard 14001).

Ask your local Leica Geosystems dealer for more information about our TQM program.

Leica Geosystems AG
Heinrich-Wild-Strasse
CH-9435 Heerbrugg
Switzerland
Phone +41 71 727 31 31
www.leica-geosystems.com

- when it has to be **right**

Leica
Geosystems